

Catalogue 2026



DLX[®]
electric

07

Kablo Kanal Sistemleri
Cable Trunking Systems

33

EKO Best Seri Kablo Kanalları
ECO Best Line Cable
Trunkings

47

DLX Line Delikli Pano Kanalları
DLX Line Slotted Cable
Trunkings

69

Döşeme Altı Çıkış Güç
Dağıtım Kutuları
Underfloor Power Distribution
Boxes

80

Masa Üstü Priz Sistemleri
Çalışma Ortamı Çözümleri
Desktop Socket Systems
Work Station Solutions

105

ABS-PC Panolar
ABS-PC Enclosures

22

Klima Kanalı
Air Condition Cable
Duct

38

EKO Best Seri Kendinden
Yapışkanlı Kablo Kanalları
ECO Best Line Self Adhesive
Cable Trunkings

53

Helezon Pano Spirali
Helicoid Panel Spiral

73

Kablo Bağları
Cable Ties

85

Elektrik Tesisat Boruları
Electrical Installation
Conduits

23

Kaidesiz Direkt Priz Montaj
Kablo Kanal Sistemleri
Frameless Direct Socket
Assembly Cable Trunking Systems

42

Canafix Seri Kablo Kanalları
Canafix Line Cable Trunkings

54

DLXFIL Tel Örgü Kablo
Kanalları
DLXFIL Wire-Mesh
Cable Trays

74

Dahili 45x45 Modül Priz Kutuları
Yapısal Kablolama Sistemleri
45x45 Socket Boxes /
Structural Cabling Systems

92

Elektrik Spiral Boruları
Electrical Installation
Corrugated Conduits

30

Aluminyum Kablo Kanal Sistemleri
Aluminium Cable Trunking Systems

45

Döşeme Üstü Kablo Kanal
Sistemleri
Overfloor Cable Trunking
Systems

62

Şebeke, UPS, Data & Telefon
Prizleri
UPS, Energy, Data & Telephone
Sockets

76

Ofis Blok Sistemleri
Block Office Systems

99

DLX FLEX
DLX FLEX

**Türkiye**

ÇEVRE DOSTU ECO FRIENDLY ENVIRONMENT

Çevreye saygılı tasarlanmış ürünler

Designed products that respect to the environment

DLX tüm tüketici ihtiyaçlarına cevap veren kaliteli çevre dostu ürünler sunar... RoHs* direktifine uyumlu ürünler.

DLX meet the needs of all consumers by offering high quality eco-friendly products in accordance with RoHs * directive compliant norms.

Geri dönüşümlü, doğada çözülebilen ambalaj kullanımı.

The use of recycled, biodegradable packaging.

%100 geri dönüşümlü M1 sınıfı orjinal PVC hammadde kullanımı.

100% recycled original M1 class PVC raw material usage.

DLX üretim tesisi ISO 9001-2015 kalite sertifikası belgelidir.

DLX manufacturing plant is certified by ISO 9001-2015 quality standards.



YENİLİKÇİ ÜRÜN SİSTEMLERİ
INNOVATIVE PRODUCT SYSTEMS



AVM'ler

Shopping Malls



Fabrika'lar

Factories



Ofisler

Offices



Kamu Kurumları

Public and Government
Institutions



Eğitim Kurumları

Educational Institutions



Sağlık Kurumları

Medical Institutions



TEKNIK ÖZELLİKLER
TECHNICAL DETAILS



Kimyasal ve Asit buharına dayanımı
Resistance to chemical and acid steam



Mekanik darbelere dayanıklı.
Resistance to mechanical shock hits 2-5 Joule



Alev aldığıında kendiliğinden sönebilen katkı maddeli PVC malzeme (UL94V0 M1).
Self extinguishing PVC fire reaction (UL94V0 M1)

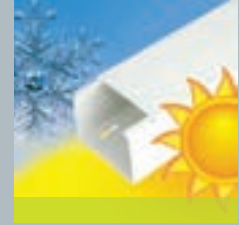

Ultraviyole ışınlarına dayanıklı (UV).
Resistance to ultraviolet lights (UV).



Boyanabilir.
Paintable



Kablo kanalları kurşunsuz hammaddeden üretilmektedir.
Use of unleaded raw materials on cable trunkings



Topraklama gerektirmez
No need for grounding

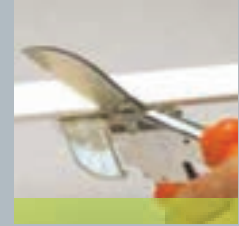

İstenilen boyutta kesilebilir.
Cut down to required size

Özel bir alet gerektirmeden montaj yapılır.
46-130 mm en, 18-50 mm derinlik arasında 9 değişik kanal.
Kanal bağlantı aksesuarları.
Data ve enerji prizleri takılabilir.
Ultraviyole ışıklara dayanıklı (UV).
Koruma sınıfı IP 40.
Dielektrik dayanımı 270 kW/cm değerindedir.
Kablo kanalları beyaz RAL 9010-9016'dır.
Karton kutu ambalaja sahiptir.
Tabanı 46 mm üzerinde olan tüm kanallar tam radiuslüdür.
Döşeme üstü kablo kanalları tam kapaklıdır.

Assembly is done without special tools.
Trunking measuring from 46 to 130 mm wide, from 18 to 50 mm depth on 9 different dimensions.
Full range of fitting and assembling accessories.
All data, power and sockets can be easily installed.
Resistant to ultraviolet lights (UV).
Protection class IP 40.
Dielectric strength level is 270 kW/cm.
Colours of trunking: White RAL 9010-9016.
Packaging with carton paper box.
Cable trunking with more than 46 mm base line have full radius.
Overfloor cable trunkings have full cover.





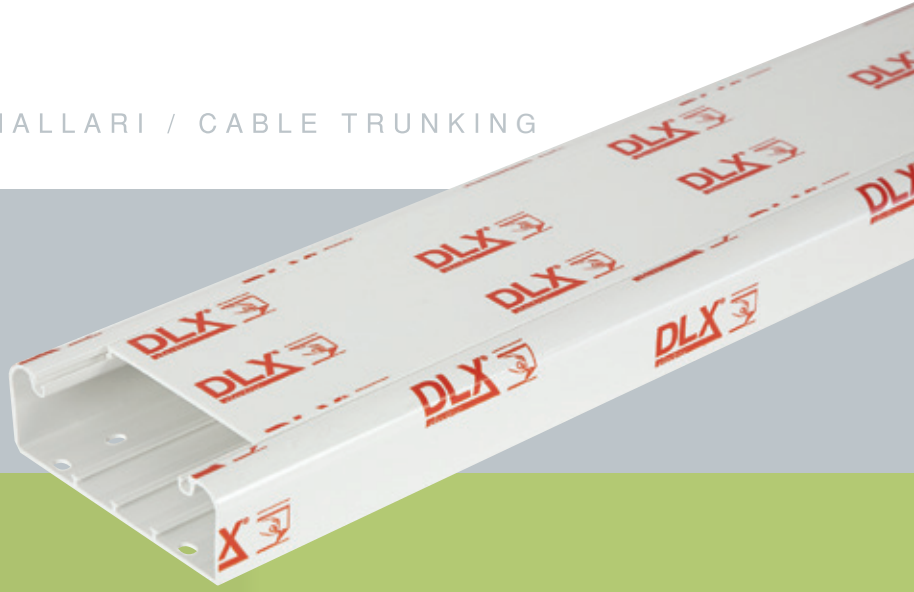

KABLO KANAL SİSTEMLERİ
CABLE TRUNKING SYSTEMS

Ref:102 34
102 x 34ET KALINLIĞI **1.8**
THICKNESS **mm**

102 11

Tekli 45x45 Kaide (2 Modül)
Top Cover Set For 45x45 (2 Module)

102 35

Ara bölme Uzunluk 2m
Divider 2m length

102 12

İkili 45x45 Kaide (4 Modül)
Double Top Cover Set
For 45x45 (4 Module)

102 01

İç Köşe (Hareketli)
Internal Corner
(Adjustable)

102 06

Kanal Birleştirme Parçası
Junction piece

102 03

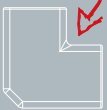
Dirsek 90° (Hareketli)
90° Corner Piece (Adjustable)

102 14

Dörtlü 45x45 Kaide
(8 Modül)
Quadruple Top Cover Set
For 45x45 (8 Module)

102 02

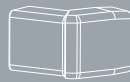
Hareketli Dış Köşe
Internal Corner (Adjustable)

102 04

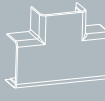
T Dirsek
T Corner

102 12

İkili 45x45 Kaide (4 Modül)
Double Top Cover
Set For 45x45 (4 Module)

102 05

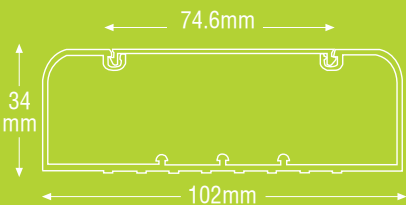
Sonlandırma Kapağı
End CoverAmbalaj: 24m
Uzunluk 2m Kesit: 102x34
Kapaklı satılır. 3 ara bölme takılabilir.
Renk RAL 9010-9016 BeyazPackaging Unit: 24m
2m length, Dimension: 102x34
Complete with cover. Up to 3 divider possibility
Color RAL 9010-9016 White

MONTAJ TAMAMLAMA AKSESUARLARI / CABLE TRUNKING ACCESSORY LINE



102 35

Ambalaj: 80m
Ara bölme Uzunluk 2m
Packaging:80m
Divider 2m length



102 01

Ambalaj: 10 Adet
İç Köşe (Hareketli)
Packaging:10 pcs
Internal Corner (Adjustable)



102 02

Ambalaj: 6 Adet
Dış Köşe (Hareketli)
Packaging: 6 pcs
External Corner (Adjustable)



102 03

Ambalaj: 6 Adet
Dirsek 90° (Hareketli)
Packaging:6 pcs
90° Corner Piece (Adjustable)



102 04

Ambalaj: 8 Adet
T Dirsek
Packaging:8 pcs
T Corner



102 05

Ambalaj: 20 Adet
Sonlandırma Kapağı
Packaging:20 pcs
End Cover



102 06

Ambalaj: 20 Adet
Kanal Birleştirme Parçası
Packaging:20 pcs
Junction piece



102 07

Ambalaj: 20 Adet
Kablo Tutucu
Packaging:20 pcs
Cable Holder

ANAHTAR PRİZ MONTAJ AKSESUARLARI / SWITCH SOCKET NETWORK ASSEMBLY SET

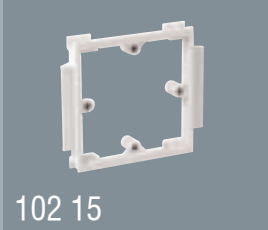

102 15

Ambalaj: 40 Adet
İngiliz Tipi Tekli Priz Çerçevesi
Packaging:40 pcs
British Type Singel Socket Frame

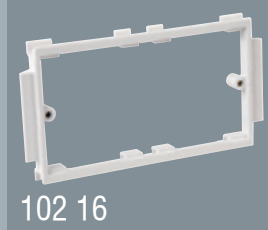

102 16

Ambalaj: 25 Adet
İngiliz Tipi İkili Priz Çerçevesi
Packaging:25 pcs
British Type Double Socket Frame

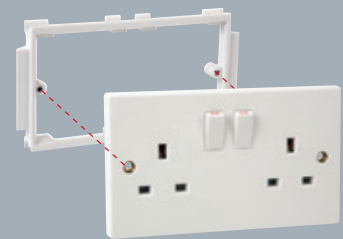

102 17

Ambalaj: 20 Adet
İngiliz Tipi Tekli Priz Kasası
Packaging:20 pcs
British Type Singel Socket Box



102 18

Ambalaj: 10 Adet
İngiliz Tipi İkili Priz Kasası
Packaging:10 pcs
British Type Double Socket Box

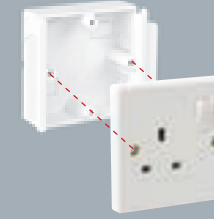

102 11

Ambalaj: 8 Adet
Tekli 45x45 Kaide (2 Modül)
Packaging: 8 pcs
Top Cover Set For 45x45
(2 Module)



102 12

Ambalaj: 15 Adet
İkili 45x45 Kaide (4 Modül)
Packaging:15 pcs
Double Top Cover Set For
45x45 (4 Module)



102 13

Ambalaj: 15 Adet
Üçlü 45x45 Kaide (6 Modül)
Packaging:15 pcs
Triple Top Cover Set For
45x45 (6 Module)



102 14

Ambalaj: 10 Adet
Dörtlü 45x45 Kaide (8 Modül)
Packaging:10 pcs
Quadruple Top Cover Set For
45x45 (8 Module)

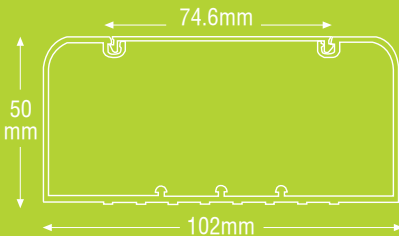
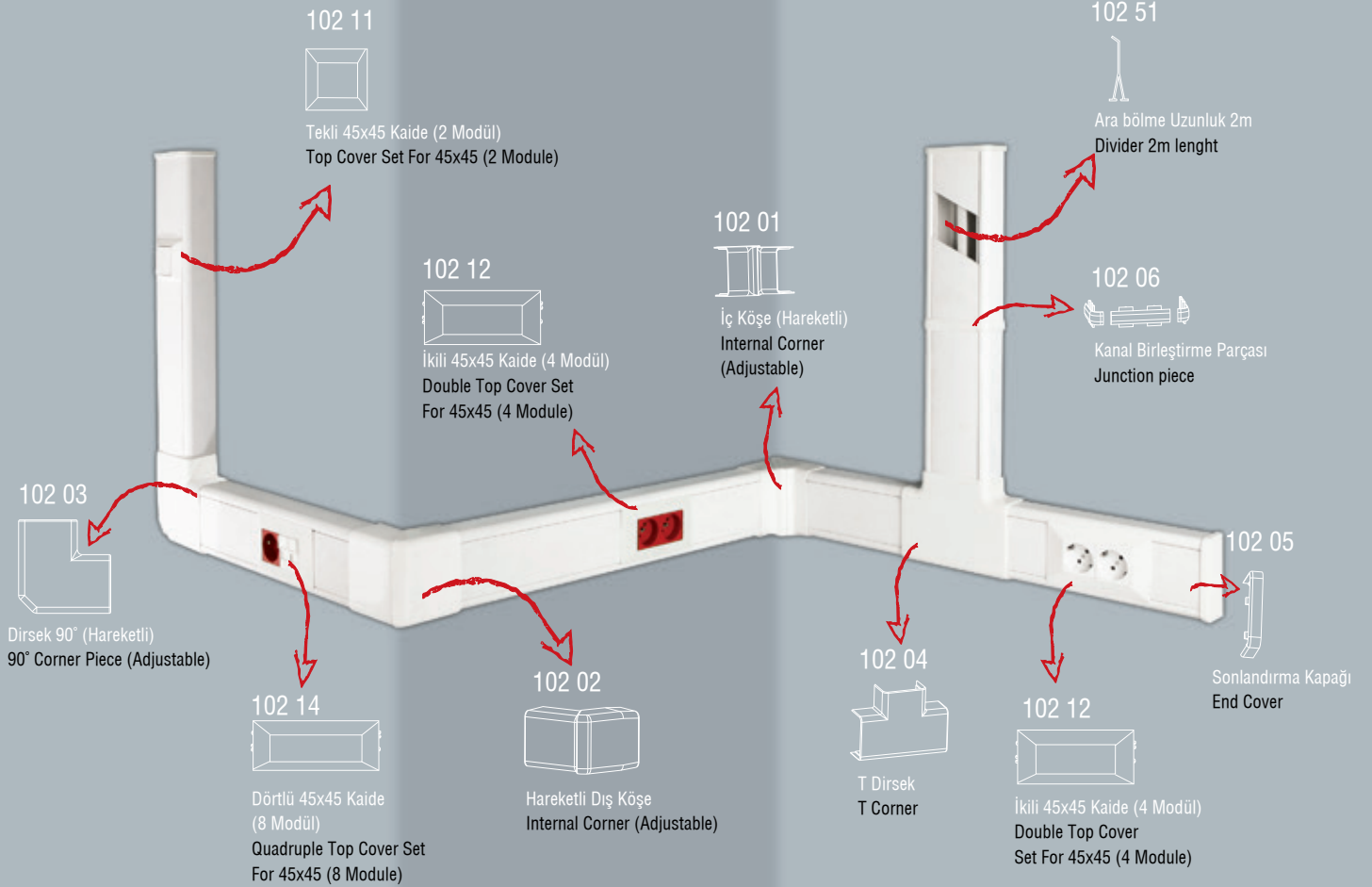
Ref:102 50
102 x 50

Ambalaj: 16m
Uzunluk 2m Kesit: 102x50
Kapaklı satılır. 3 ara bölme takılabilir.
Renk RAL 9010-9016 Beyaz

Packaging Unit: 16m
2m lenght, Dimensions: 102x50
Complete with cover. Up to 3 divider possibility
Color RAL 9010-9016 White



102 09
Ambalaj: 10 Adet
Kanal İçi Klemens Buatı (Küp)
Packaging: 10 pcs
Terminal Connection Box

MONTAJ TAMAMLAMA AKSESUARLARI / CABLE TRUNKING ACCESSORY LINE



102 51

Ambalaj: 50m
Ara bölme Uzunluk 2m
Packaging:50m
Divider 2m lenght



102 01

Ambalaj: 10 Adet
İç Köşe (Hareketli)
Packaging:10 pcs
Internal Corner (Adjustable)



102 02

Ambalaj: 6 Adet
Dış Köşe (Hareketli)
Packaging:6 pcs
External Corner (Adjustable)



102 03

Ambalaj: 6 Adet
Dirsek 90° (Hareketli)
Packaging:6 pcs
90° Corner Piece (Adjustable)



102 04

Ambalaj: 8 Adet
T Dirsek
Packaging:8 pcs
T Corner



102 05

Ambalaj: 20 Adet
Sonlandırma Kapağı
Packaging: 20 pcs
End Cover



102 06

Ambalaj: 20 Adet
Kanal Birleştirme Parçası
Packaging:20 pcs
Junction piece



102 07

Ambalaj: 20 Adet
Kablo Tutucu
Packaging:20 pcs
Cable Holder

ANAHTAR PRİZ MONTAJ AKSESUARLARI / SWITCH SOCKET NETWORK ASSEMBLY SET

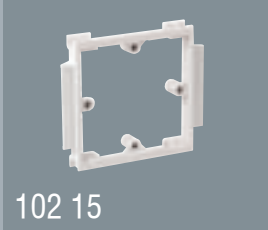

102 15

Ambalaj: 40 Adet
İngiliz Tipi Tekli Priz Çerçevesi
Packaging:40 pcs
British Type Singel Socket Frame

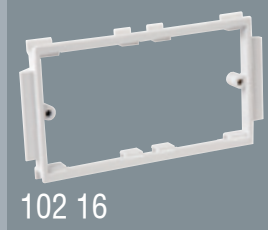

102 16

Ambalaj: 25 Adet
İngiliz Tipi İkili Priz Çerçevesi
Packaging:25 pcs
British Type Double Socket Frame

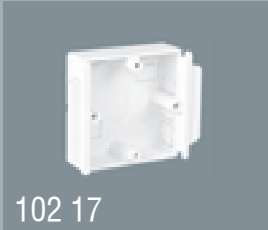
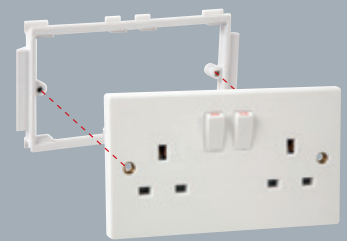
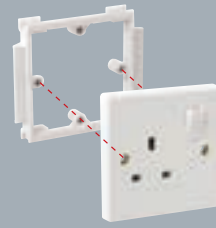

102 17

Ambalaj: 20 Adet
İngiliz Tipi Tekli Priz Kasası
Packaging:20 pcs
British Type Singel Socket Box



102 18

Ambalaj: 10 Adet
İngiliz Tipi İkili Priz Kasası
Packaging:10 pcs
British Type Double Socket Box

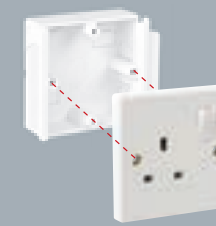

102 11

Ambalaj: 8 Adet
Tekli 45x45 Kaide (2 Modül)
Packaging: 8 pcs
Top Cover Set For 45x45
(2 Module)



102 12

Ambalaj: 15 Adet
İkili 45x45 Kaide (4 Modül)
Packaging:15 pcs
Double Top Cover Set For
45x45 (4 Module)



102 13

Ambalaj: 15 Adet
Üçlü 45x45 Kaide (6 Modül)
Packaging:15 pcs
Triple Top Cover Set For
45x45 (6 Module)



102 14

Ambalaj: 10 Adet
Dörtlü 45x45 Kaide (8 Modül)
Packaging:10 pcs
Quadruple Top Cover Set For
45x45 (8 Module)

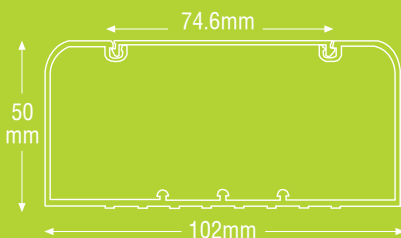
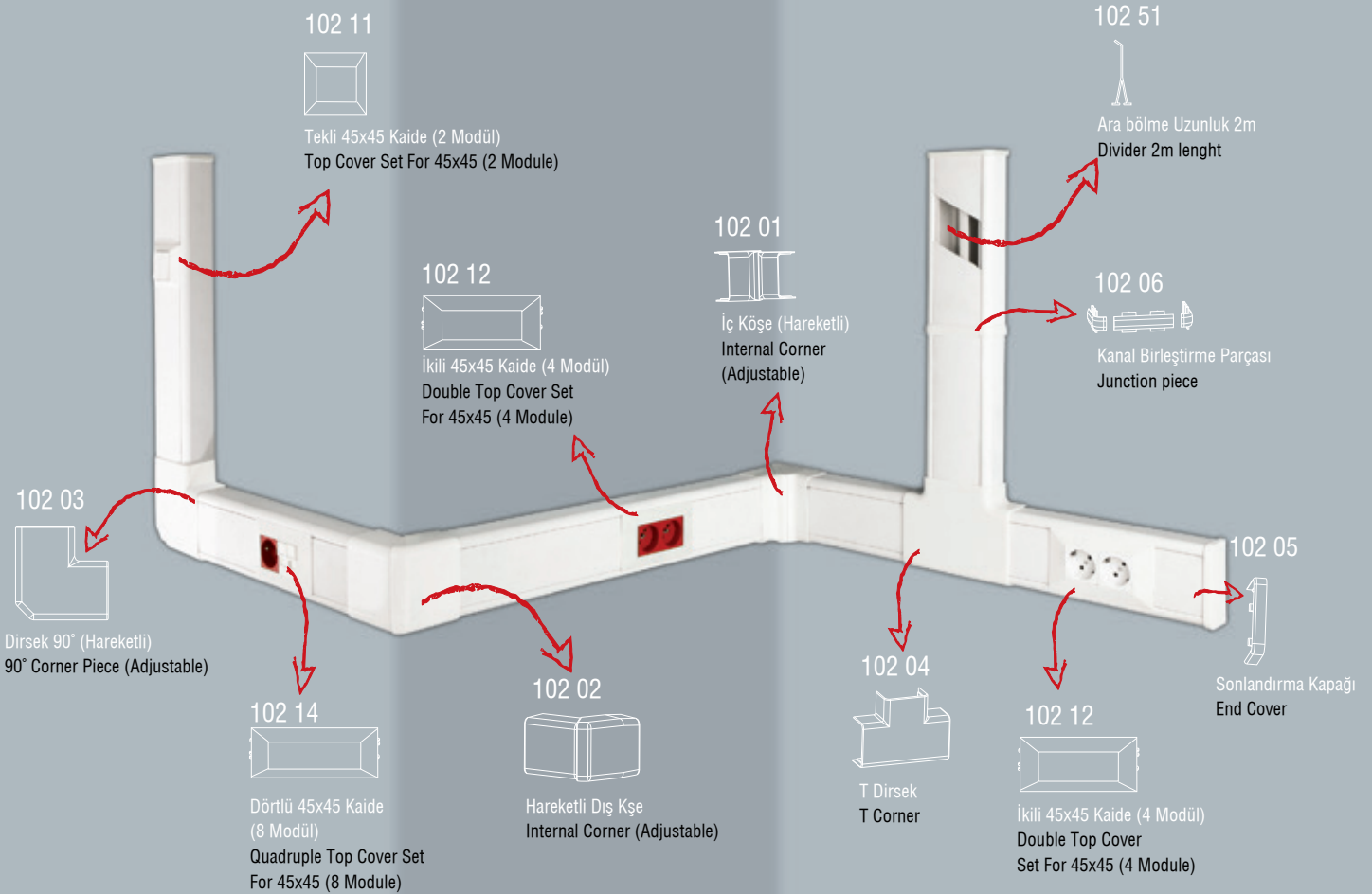
Ref:102 50 EC
102 x 50**DLX**
electric
basic

Ambalaj: 16m
Uzunluk 2m Kesit: 102x50
Kapaklı satılır. 3 ara bölme takılabilir.
Renk RAL 9010-9016 Beyaz

Packaging Unit: 16m
2m length, Dimensions: 102x50
Complete with cover. Up to 3 divider possibility
Color RAL 9010-9016 White

**102 09**

Ambalaj: 10 Adet
Kanal İçi Klemens Buatı (Küp)
Packaging: 10 pcs
Terminal Connection Box

MONTAJ TAMAMLAMA AKSESUARLARI / CABLE TRUNKING ACCESSORY LINE



102 51

Ambalaj: 50m
Ara bölme Uzunluk 2m
Packaging:50m
Divider 2m lenght



102 01

Ambalaj: 10 Adet
İç Köşe (Hareketli)
Packaging:10 pcs
Internal Corner (Adjustable)



102 02

Ambalaj: 6 Adet
Dış Köşe (Hareketli)
Packaging:6 pcs
External Corner (Adjustable)



102 03

Ambalaj: 6 Adet
Dirsek 90° (Hareketli)
Packaging:6 pcs
90° Corner Piece (Adjustable)



102 04

Ambalaj: 8 Adet
T Dirsek
Packaging:8 pcs
T Corner



102 05

Ambalaj: 20 Adet
Sonlandırma Kapağı
Packaging: 20 pcs
End Cover



102 06

Ambalaj: 20 Adet
Kanal Birleştirme Parçası
Packaging:20 pcs
Junction piece



102 07

Ambalaj: 20 Adet
Kablo Tutucu
Packaging:20 pcs
Cable Holder

ANAHTAR PRİZ MONTAJ AKSESUARLARI / SWITCH SOCKET NETWORK ASSEMBLY SET

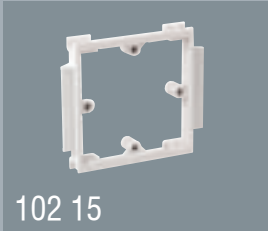

102 15

Ambalaj: 40 Adet
İngiliz Tipi Tekli Priz Çerçevesi
Packaging:40 pcs
British Type Singel Socket Frame

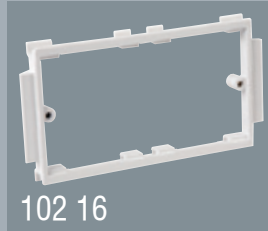

102 16

Ambalaj: 25 Adet
İngiliz Tipi İkili Priz Çerçevesi
Packaging:25 pcs
British Type Double Socket Frame

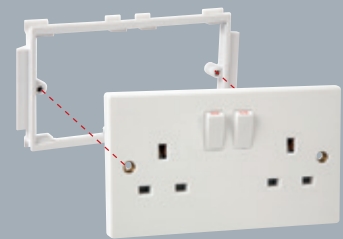
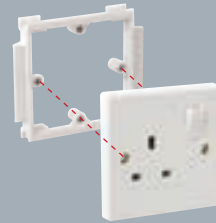

102 17

Ambalaj: 20 Adet
İngiliz Tipi Tekli Priz Kasası
Packaging:20 pcs
British Type Singel Socket Box



102 18

Ambalaj: 10 Adet
İngiliz Tipi İkili Priz Kasası
Packaging:10 pcs
British Type Double Socket Box



102 11

Ambalaj: 8 Adet
Tekli 45x45 Kaide (2 Modül)
Packaging: 8 pcs
Top Cover Set For 45x45
(2 Module)



102 12

Ambalaj: 15 Adet
İkili 45x45 Kaide (4 Modül)
Packaging:15 pcs
Double Top Cover Set For
45x45 (4 Module)



102 13

Ambalaj: 15 Adet
Üçlü 45x45 Kaide (6 Modül)
Packaging:15 pcs
Triple Top Cover Set For
45x45 (6 Module)



102 14

Ambalaj: 10 Adet
Dörtlü 45x45 Kaide (8 Modül)
Packaging:10 pcs
Quadruple Top Cover Set For
45x45 (8 Module)

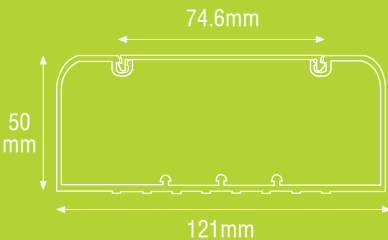
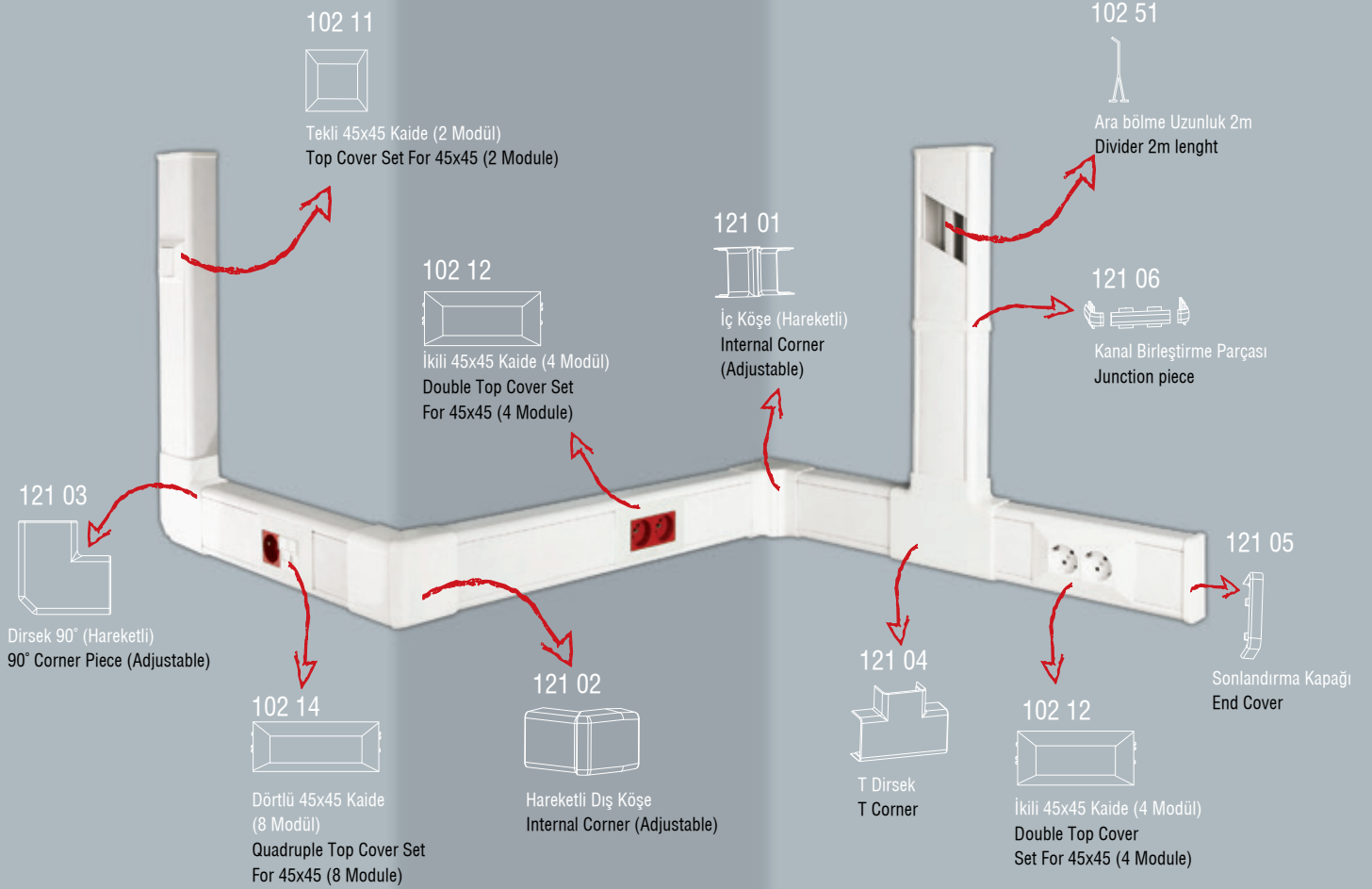
Ref:121 50
121 x 50**ET KALINLIĞI 2.2**
THICKNESS mm

Ambalaj: 16m
Uzunluk 2m Kesit: 121x50
Kapaklı satılır. 3 ara bölme takılabilir.
Renk RAL 9010-9016 Beyaz

Packaging Unit: 16m
2m length, Dimensions: 121x50
Complete with cover. Up to 3 divider possibility
Color RAL 9010-9016 White



102 09

Ambalaj: 10 Adet
Kanal İçi Klemens Buatı (Küp)
Packaging: 10 pcs
Terminal Connection Box

MONTAJ TAMAMLAMA AKSESUARLARI / CABLE TRUNKING ACCESSORY LINE



102 51

Ambalaj: 50m
Ara bölme Uzunluk 2m
Packaging: 50m
Divider 2m lenght



121 01

Ambalaj: 4 Adet
İç Köşe (Hareketli)
Packaging: 4 pcs
Internal Corner (Adjustable)



121 02

Ambalaj: 4 Adet
Dış Köşe (Hareketli)
Packaging: 4 pcs
External Corner (Adjustable)



121 03

Ambalaj: 4 Adet
Dirsek 90° (Hareketli)
Packaging: 4 pcs
90° Corner Piece (Adjustable)



121 04

Ambalaj: 4 Adet
T Dirsek
Packaging: 4 pcs
T Branches



121 05

Ambalaj: 15 Adet
Sonlandırma Kapağı
Packaging: 15 pcs
End Cover



121 06

Ambalaj: 10 Adet
Kanal Birleştirme Parçası
Packaging: 10 pcs
Junction piece



102 07

Ambalaj: 10 Adet
Kablo Tutucu
Packaging: 10 pcs
Cable Holder

ANAHTAR PRİZ MONTAJ AKSESUARLARI / SWITCH SOCKET NETWORK ASSEMBLY SET

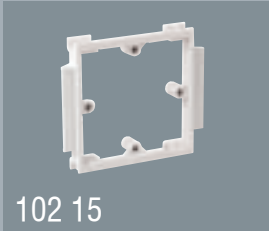

102 15

Ambalaj: 40 Adet
İngiliz Tipi Tekli Priz Çerçevesi
Packaging: 40 pcs
British Type Singel Socket Frame

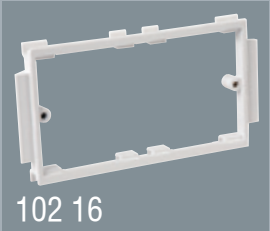

102 16

Ambalaj: 25 Adet
İngiliz Tipi İkili Priz Çerçevesi
Packaging: 25 pcs
British Type Double Socket Frame

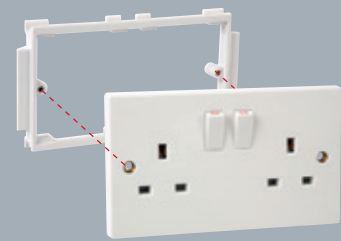
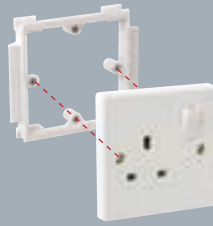

102 17

Ambalaj: 20 Adet
İngiliz Tipi Tekli Priz Kasası
Packaging: 20 pcs
British Type Singel Socket Box



102 18

Ambalaj: 10 Adet
İngiliz Tipi İkili Priz Kasası
Packaging: 10 pcs
British Type Double Socket Box

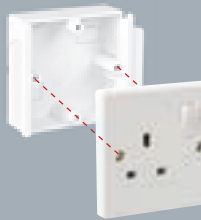

102 11

Ambalaj: 8 Adet
Tekli 45x45 Kaide (2 Modül)
Packaging: 8 pcs
Top Cover Set For 45x45
(2 Module)



102 12

Ambalaj: 15 Adet
İkili 45x45 Kaide (4 Modül)
Packaging: 15 pcs
Double Top Cover Set For
45x45 (4 Module)



102 13

Ambalaj: 15 Adet
Üçlü 45x45 Kaide (6 Modül)
Packaging: 15 pcs
Triple Top Cover Set For
45x45 (6 Module)



102 14

Ambalaj: 10 Adet
Dörtlü 45x45 Kaide (8 Modül)
Packaging: 10 pcs
Quadruple Top Cover Set For
45x45 (8 Module)

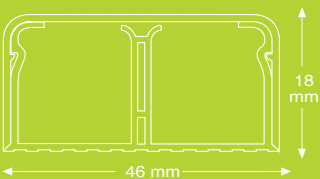
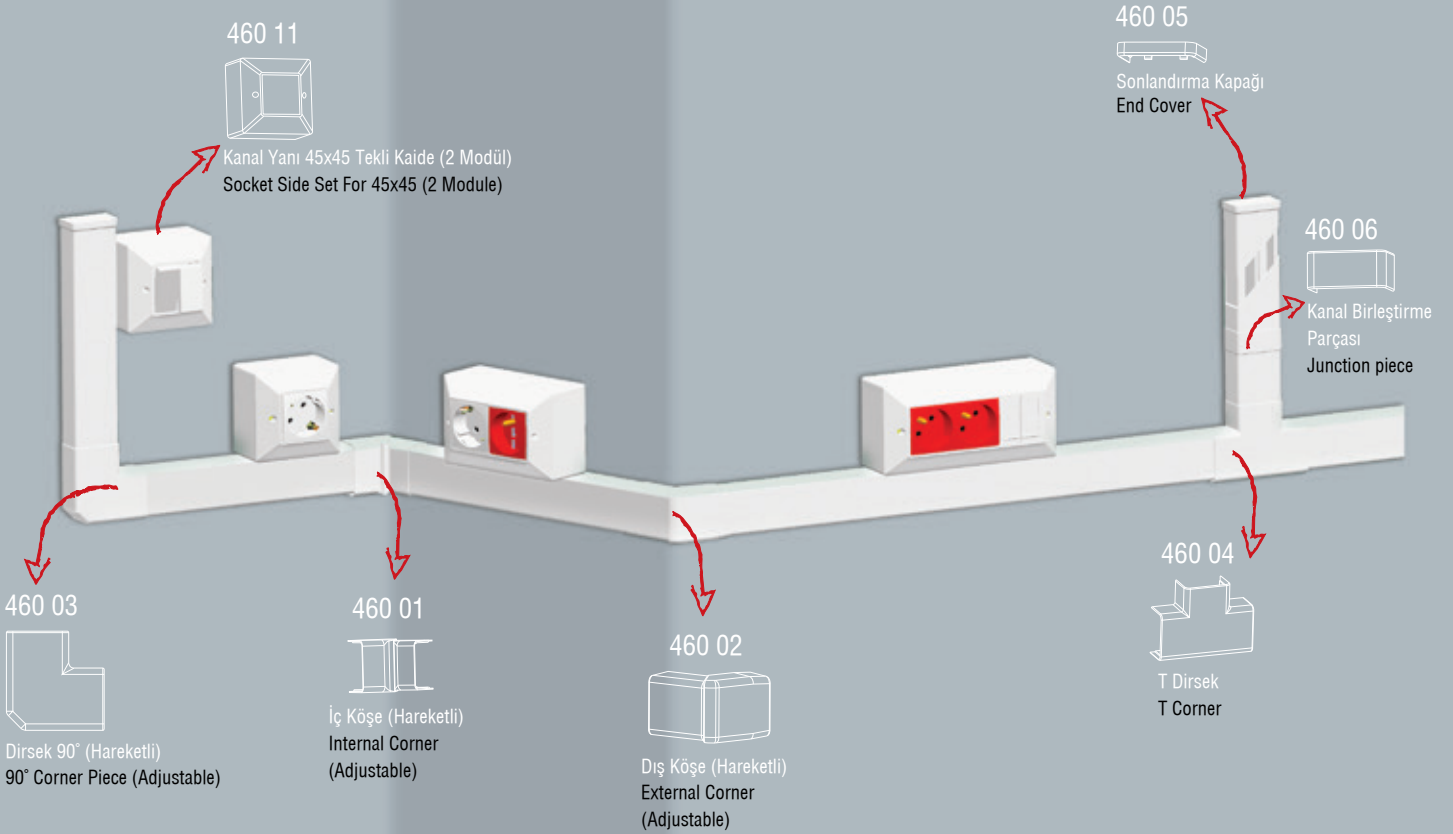
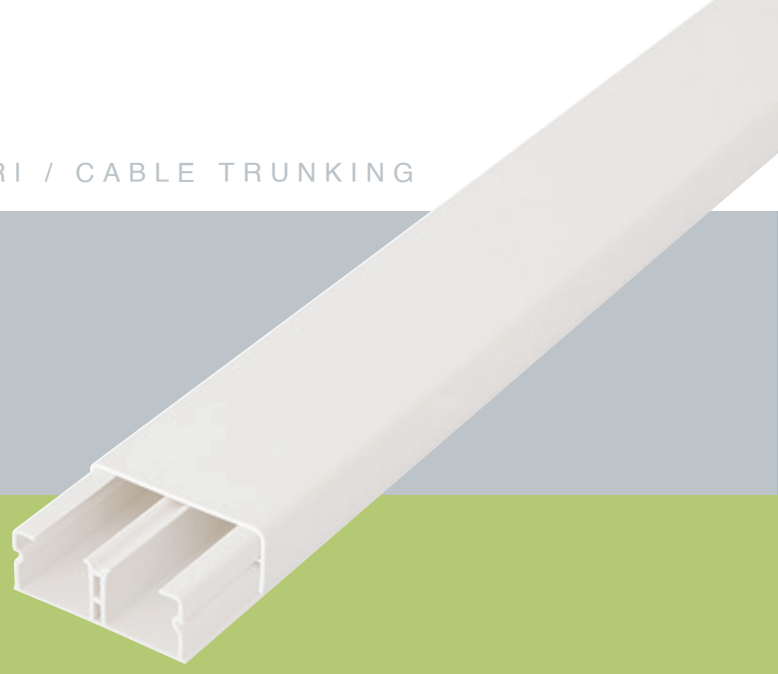
Ref:460 18
46 x 18

Ambalaj: 60m
Uzunluk 2m Kesit: 46x18
Kapaklı satılır. Kendinden bölmelidir.
Renk RAL 9010-9016 Beyaz

Packaging Unit: 60m
2m length, Dimensions: 46x18
Complete with cover. Produced with the separator part.
Color RAL 9010-9016 White

MONTAJ TAMAMLAMA AKSESUARLARI / CABLE TRUNKING ACCESSORY LINE

460 01

Ambalaj: 6 Adet
İç Köşe (Hareketli)
Packaging:6 pcs
Internal Corner (Adjustable)



460 02

Ambalaj: 6 Adet
Dış Köşe (Hareketli)
Packaging:6 pcs
External Corner (Adjustable)



460 03

Ambalaj: 6 Adet
Dirsek 90° (Hareketli)
Packaging:6 pcs
90° Corner Piece (Adjustable)



460 04

Ambalaj: 6 Adet
T Dirsek
Packaging:6 pcs
T Corner



460 05

Ambalaj: 50 Adet
Sonlandırma Kapağı
Packaging:50 pcs
End Cover



460 06

Ambalaj: 50 Adet
Kanal Birleştirme Parçası
Packaging:50 pcs
Junction piece

**ANAHTAR PRİZ MONTAJ AKSESUARLARI / SWITCH SOCKET NETWORK ASSEMBLY SET**

460 11

Ambalaj: 10 Adet
Kanal Yanı 45x45 Tekli Kaide
(2 Modül)
Packaging:10 pcs
Socket Side Set For 45x45
(2 Module)



460 15

Ambalaj: 15 Adet
Sıvaüstü tekli kasa (universal tip)
Packaging:15 pcs
Surface-mounted single box (universal type)

Uygulama / Application

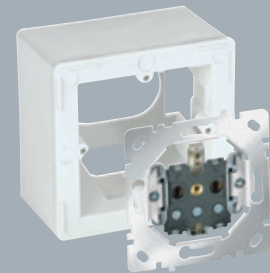

Ref:461 18
46 x 18
Bölmesiz
(Without Separator)

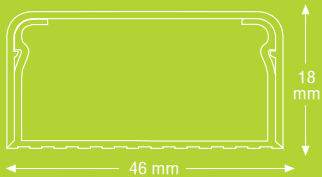
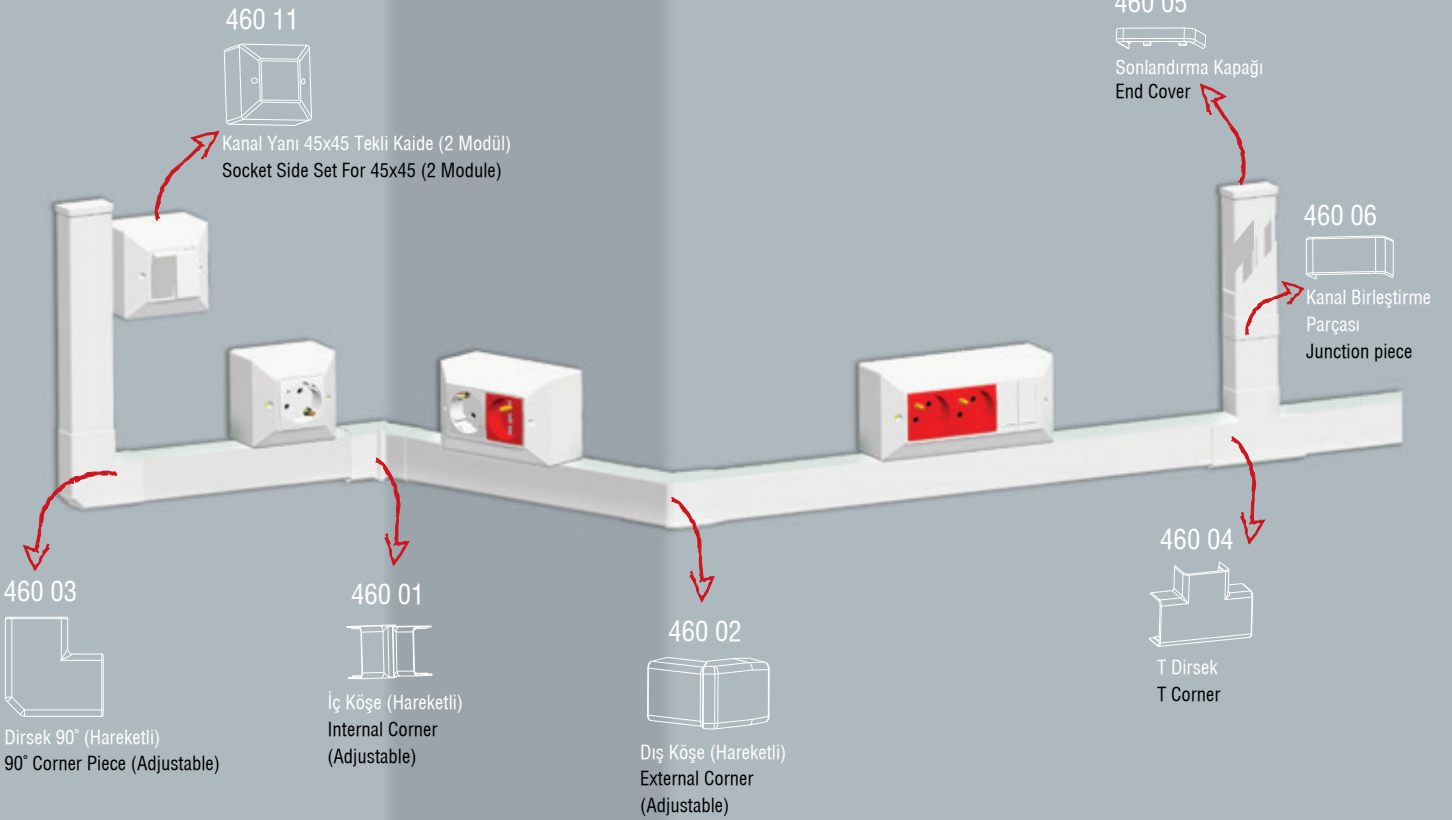
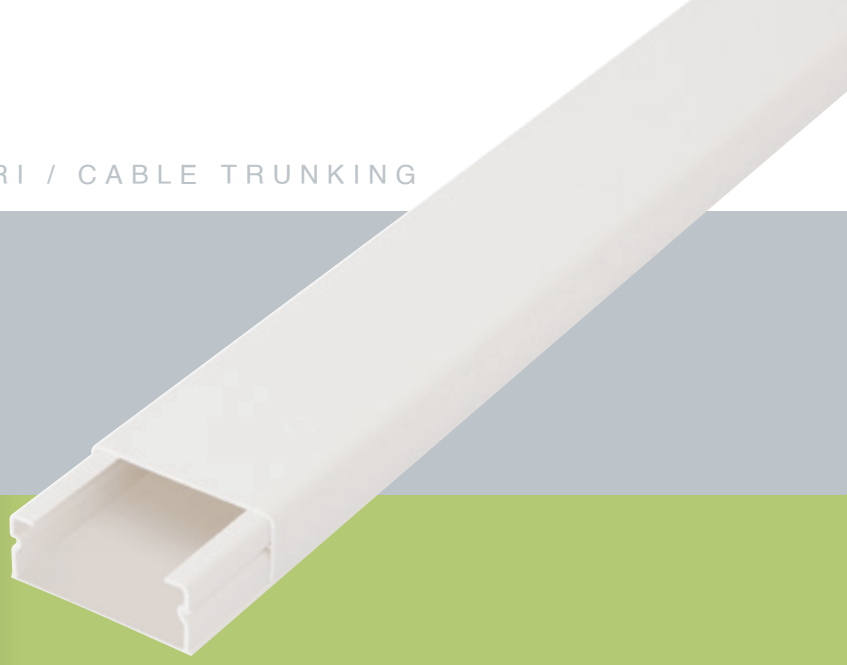

Ambalaj: 60m
Uzunluk 2m Kesit: 46x18
Kapaklı satılır.
Renk RAL 9010-9016 Beyaz

Packaging Unit: 60m
2m length, Dimensions: 46x18
Complete with cover.
Color RAL 9010-9016 White

MONTAJ TAMAMLAMA AKSESUARLARI / CABLE TRUNKING ACCESSORY LINE

460 01

Ambalaj: 6 Adet
İç Köşe (Hareketli)
Packaging: 6 pcs
Internal Corner (Adjustable)



460 02

Ambalaj: 6 Adet
Dış Köşe (Hareketli)
Packaging: 6 pcs
External Corner (Adjustable)



460 03

Ambalaj: 6 Adet
Dirsek 90° (Hareketli)
Packaging: 6 pcs
90° Corner Piece (Adjustable)



460 04

Ambalaj: 6 Adet
T Dirsek
Packaging: 6 pcs
T Corner



460 05

Ambalaj: 50 Adet
Sonlandırma Kapağı
Packaging: 50 pcs
End Cover



460 06

Ambalaj: 50 Adet
Kanal Birleştirme Parçası
Packaging: 50 pcs
Junction piece

**ANAHTAR PRİZ MONTAJ AKSESUARLARI / SWITCH SOCKET NETWORK ASSEMBLY SET**

460 11

Ambalaj: 10 Adet
Kanal Yanı 45x45 Tekli Kaide
(2 Modül)
Packaging: 10 pcs
Socket Side Set For 45x45 (2 Module)



460 15

Ambalaj: 10 Adet
Sıvaüstü tekli kasa (universal tip)
Packaging: 10 pcs
Surface-mounted single box (universal type)

Uygulama / Application

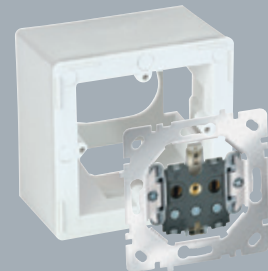

Ref:460 25
46 x 25

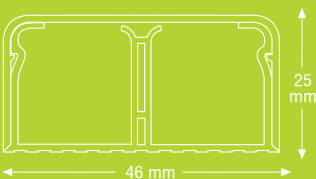
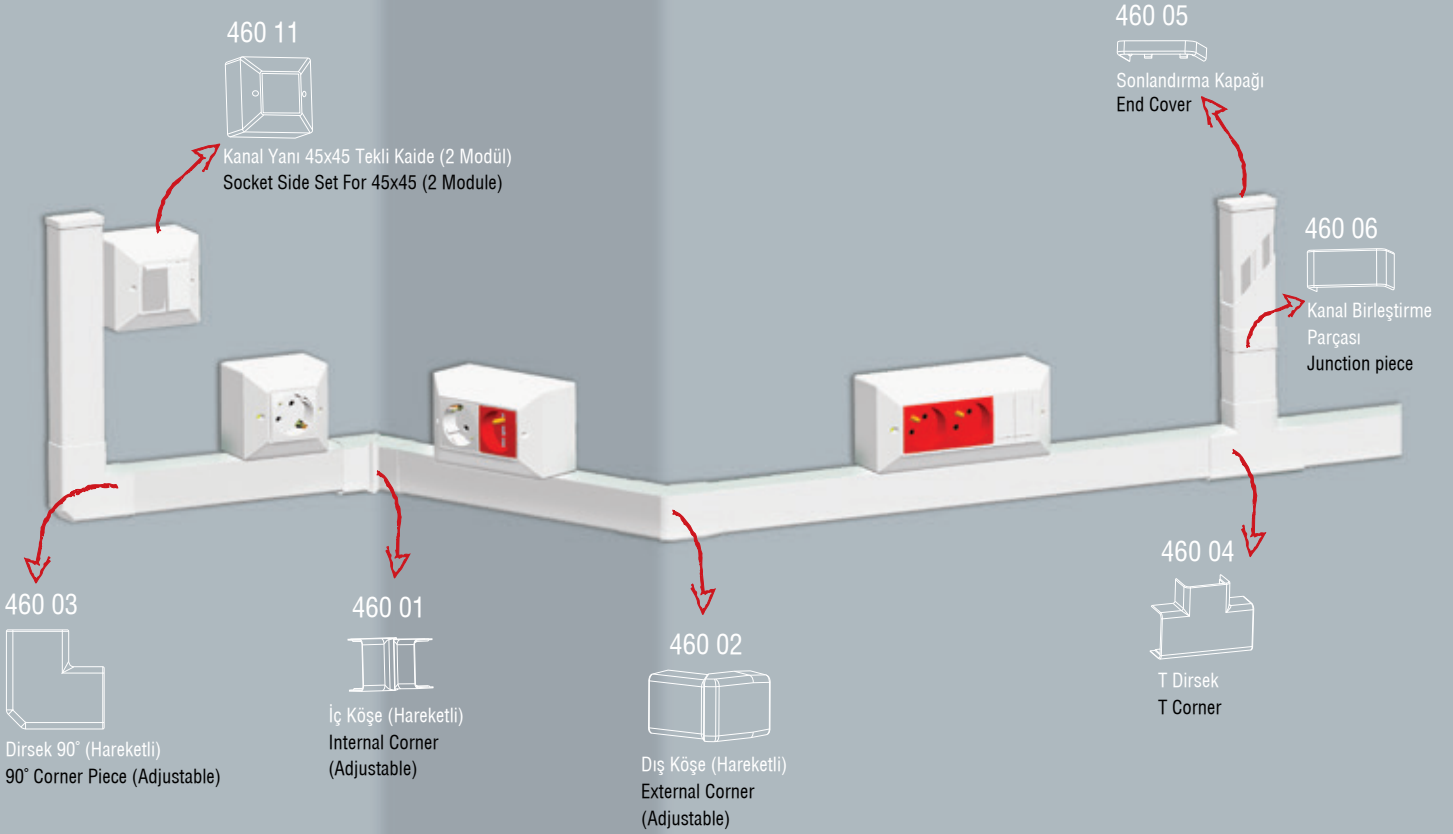
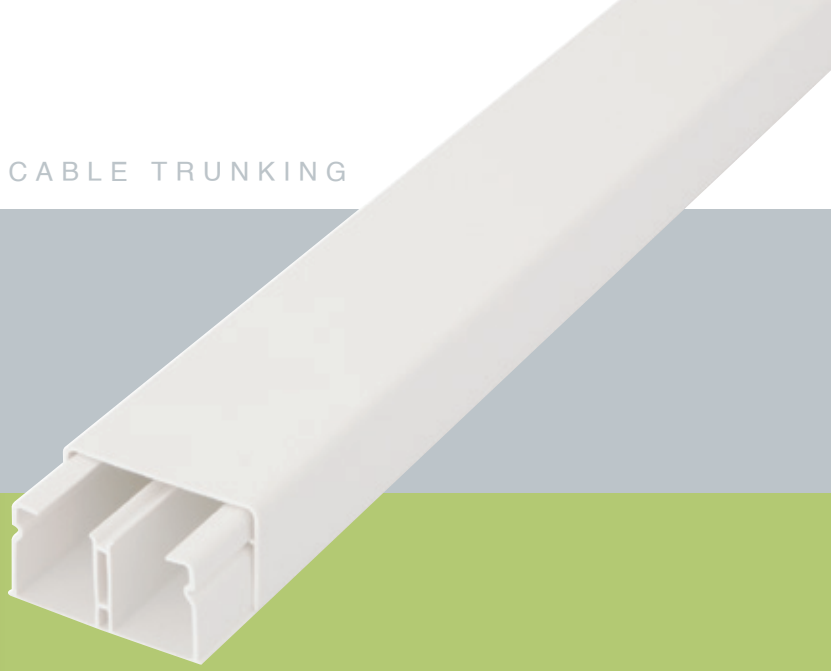

Ambalaj: 50m
Uzunluk 2m Kesit: 46x25
Kapaklı satılır. Kendinden bölmelidir.
Renk RAL 9010-9016 Beyaz

Packaging Unit: 50m
2m length, Dimensions: 46x25
Complete with cover. Produced with the separator part.
Color RAL 9010-9016 White

MONTAJ TAMAMLAMA AKSESUARLARI / CABLE TRUNKING ACCESSORY LINE

460 01

Ambalaj: 6 Adet
İç Köşe (Hareketli)
Packaging:6 pcs
Internal Corner (Adjustable)



460 02

Ambalaj: 6 Adet
Dış Köşe (Hareketli)
Packaging: 6 pcs
External Corner (Adjustable)



460 03

Ambalaj: 6 Adet
Dirsek 90° (Hareketli)
Packaging: 6 pcs
90° Corner Piece (Adjustable)



460 04

Ambalaj: 6 Adet
T Dirsek
Packaging:6 pcs
T Corner



460 05

Ambalaj: 50 Adet
Sonlandırma Kapağı
Packaging:50 pcs
End Cover



460 06

Ambalaj: 50 Adet
Kanal Birleştirme Parçası
Packaging:50 pcs
Junction piece

**ANAHTAR PRİZ MONTAJ AKSESUARLARI / SWITCH SOCKET NETWORK ASSEMBLY SET**

460 11

Ambalaj: 10 Adet
Kanal Yanı 45x45 Tekli Kaide
(2 Modül)
Packaging:10 pcs
Socket Side Set For 45x45 (2 Module)



460 15

Ambalaj: 10 Adet
Sıvaüstü tekli kasa (universal tip)
Packaging:10 pcs
Surface-mounted single box (universal type)

Uygulama / Application

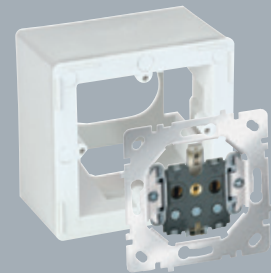

Ref:705 45
70 x 45

DLX
electric

KLİMA KANALI

Air Condition Cable Duct



Ref.
700 45

Klima Kanalı
Ambalaj: 48m
Air Conditioner Trunk
Packaging: 48 m

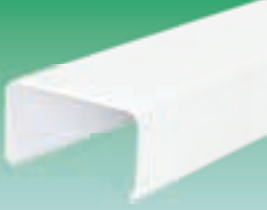

Ref.
700 46

Duvar Montaj Kelepçesi
Ambalaj: 10 Adet
Wall Mounting Clamp
Packaging: 10pcs



Ref.
700 01

İç Köşe
Ambalaj: 10 Adet
Interior Corner
Packaging: 10pcs



Ref.
700 02

Dış Köşe
Ambalaj: 10 Adet
Exterior Corner
Packaging: 10pcs



Ref.
700 03

90° Dirsek
Ambalaj: 10 Adet
90° L Corner
Packaging: 10pcs



Ref.
700 04

Kanal Birleştirme Parçası
Ambalaj: 15 Adet
Junction Piece
Packaging: 15pcs



Ref.
700 05

Sonlandırma Kapağı
Ambalaj: 20 Adet
End Cover
Packaging: 20pcs





Geniş Ürün Yelpazesi



kaidesiz 45x45 mm direkt priz
montajına uygun çözümler

*Wide product range offering solutions for
frameless direct socket installation*



85x50
100x50
130x50

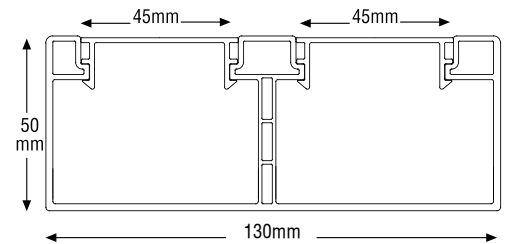
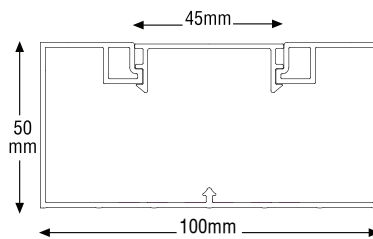
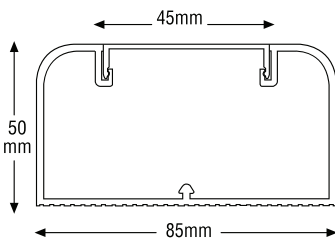

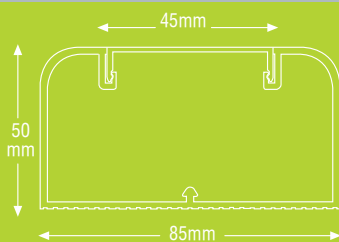
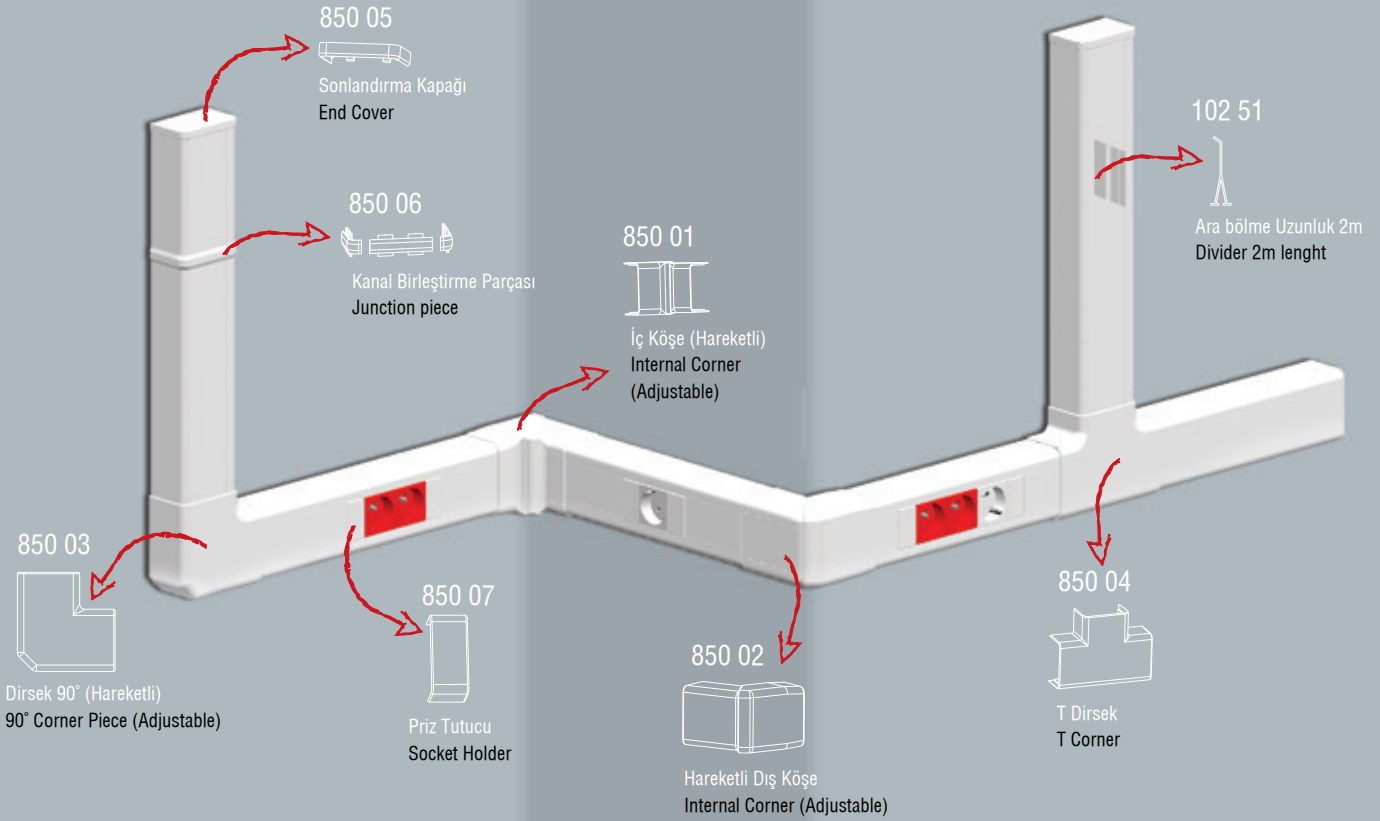
Ref:85 050
85 x 50**DLX**
electric
prime

Ambalaj: 16m
Uzunluk 2m Kesit: 85x50
Kapaklı satılır.
Renk RAL 9010-9016 Beyaz

Packaging Unit: 16m
2m length, Dimensions: 85x50
Complete with cover.
Color RAL 9010-9016 White

Kanal üzerine çerçevesiz direk priz montajı
Frameless socket assembling on cable trunking (Direct socket assembling)

MONTAJ TAMAMLAMA AKSESUARLARI / CABLE TRUNKING ACCESSORY LINE**102 51**

Ambalaj: 50m
Ara bölme Uzunluk 2m
Packaging:50m
Divider 2m lenght

**850 01**

Ambalaj: 5 Adet
İç Köşe
Packaging:5 pcs
Internal Corner

**850 02**

Ambalaj: 5 Adet
Dış Köşe
Packaging:5 pcs
External Corner

**850 03**

Ambalaj: 5 Adet
Dirsek 90° (Hareketli)
Packaging:5 pcs
90° Corner Piece (Adjustable)

**850 04**

Ambalaj: 5 Adet
T Dirsek
Packaging:5 pcs
T Corner

**850 05**

Ambalaj: 10 Adet
Sonlandırma Kapağı
Packaging:10 pcs
End Cover

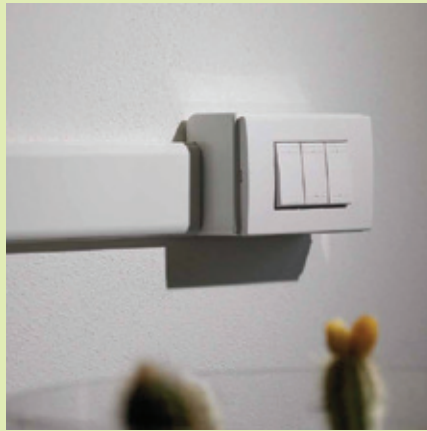



DLX
electric
prime

HIZLI KURULUM
PRATİK MONTAJ
DÜŞÜK MALİYET
FAST INSTALLATION
EASY ASSEMBLY
BUDGET FRIENDLY

Ref:100 50
100 x 50

DLX
electronic
prime

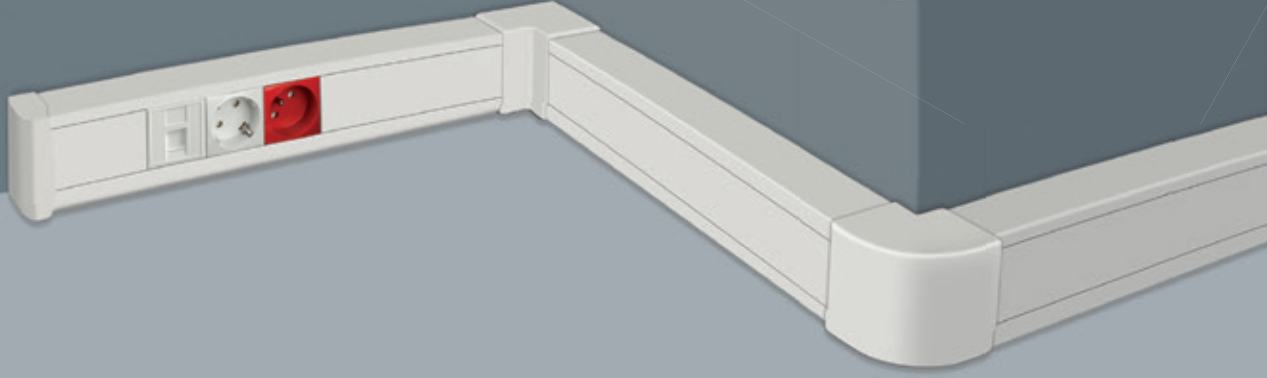

MONTAJ TAMAMLAMA AKSESUARLARI / CABLE TRUNKING ACCESSORY LINE



105 01

Ambalaj: 8 Adet
İç Köşe
Packaging:8 pcs
Internal Corner



105 02

Ambalaj: 10 Adet
Dış Köşe
Packaging:10 pcs
External Corner



105 03

Ambalaj: 8 Adet
Dirsek 90° (Hareketli)
Packaging:8 pcs
90° Corner Piece (Adjustable)

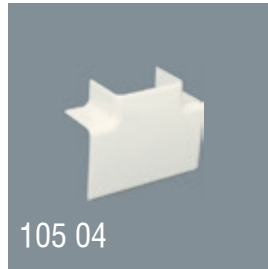

105 04

Ambalaj: 8 Adet
T Dirsek
Packaging:8 pcs
T Corner



105 05

Ambalaj: 20 Adet
Sonlandırma Kapağı
Packaging:20 pcs
End Cover

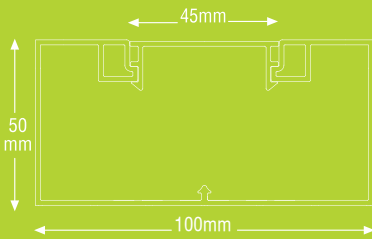

Ref:130 50
130 x 50

DLX
electric
prime

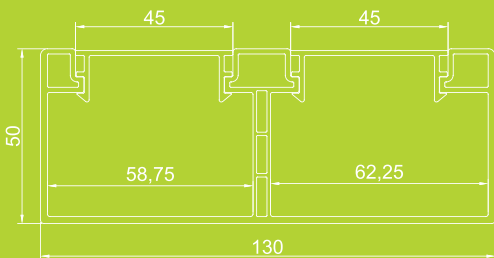
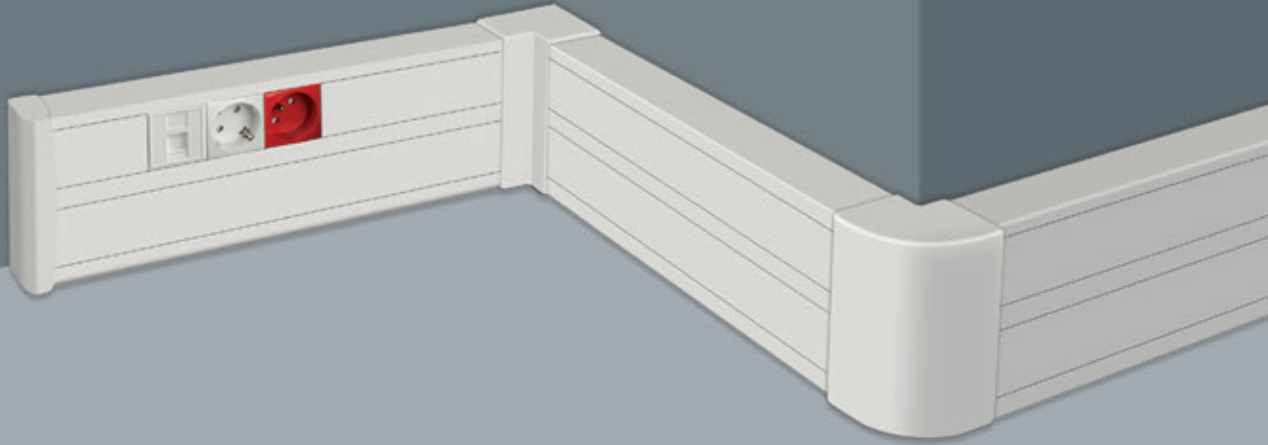
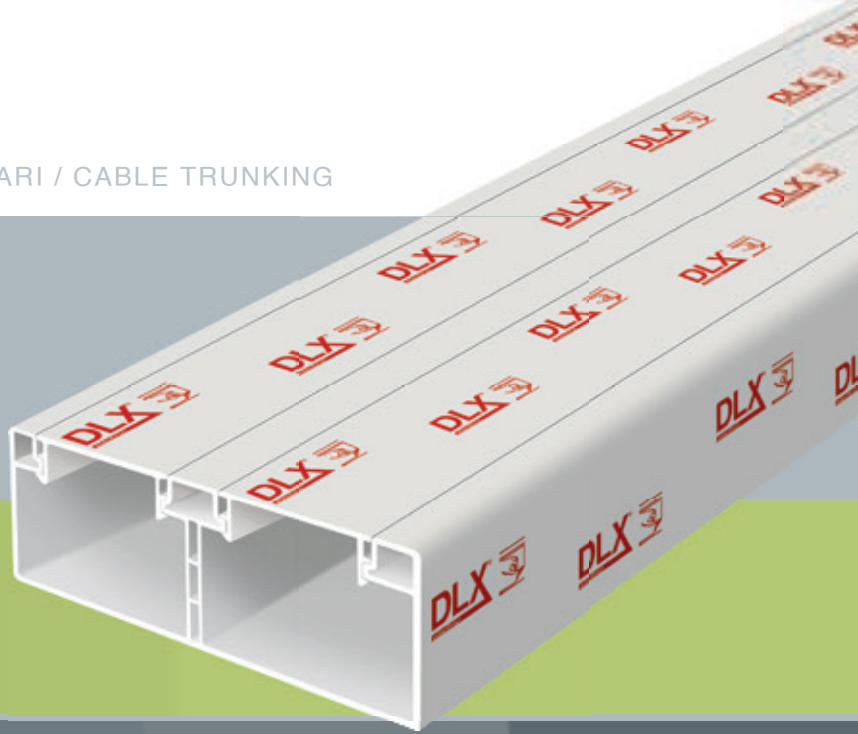

Çift Kompartmanlı Kanal

Ambalaj: 12m
Uzunluk 2m Kesit: 130x50
2 Adet Kapaklı satılır.
Renk RAL 9010-9016 Beyaz

Two Compartment Trunk

Packaging Unit: 12m
2m length, Dimensions: 130x50
2 Pieces Complete with cover.
Color RAL 9010-9016 White

Kanal üzerine çerçevesiz direk priz montajı
Frameless socket assembling on cable trunking (Direct socket assembling)

MONTAJ TAMAMLAMA AKSESUARLARI / CABLE TRUNKING ACCESSORY LINE

130 01

Ambalaj: 5 Adet
İç Köşe
Packaging:5 pcs
Internal Corner



130 02

Ambalaj: 5 Adet
Dış Köşe
Packaging:5 pcs
External Corner



130 03

Ambalaj: 5 Adet
Dirsek 90° (Hareketli)
Packaging:5 pcs
90° Corner Piece (Adjustable)



130 04

Ambalaj: 5 Adet
T Dirsek
Packaging:5 pcs
T Corner



130 05

Ambalaj: 10 Adet
Sonlandırma Kapağı
Packaging:10 pcs
End Cover



DLX[®] alutrunk



RENK SEÇENEKLERİ / COLOR OPTIONS

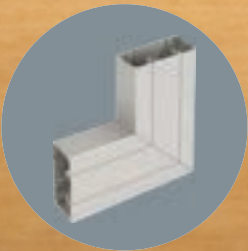

Mat Beyaz Eloksal XXX

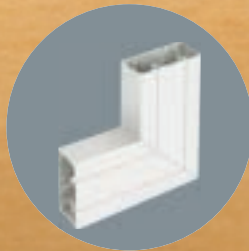

Beyaz RAL9010



Siyah RAL9005

- Dayanıklı
- Estetik
- Kolay Montaj
- Durable
- Aesthetic
- Easy to Instal

ALUMINYUM KABLO KANAL SİSTEMLERİ ALUMINIUM CABLE TRUNKING SYSTEMS

Ref:104 50
100 x 50

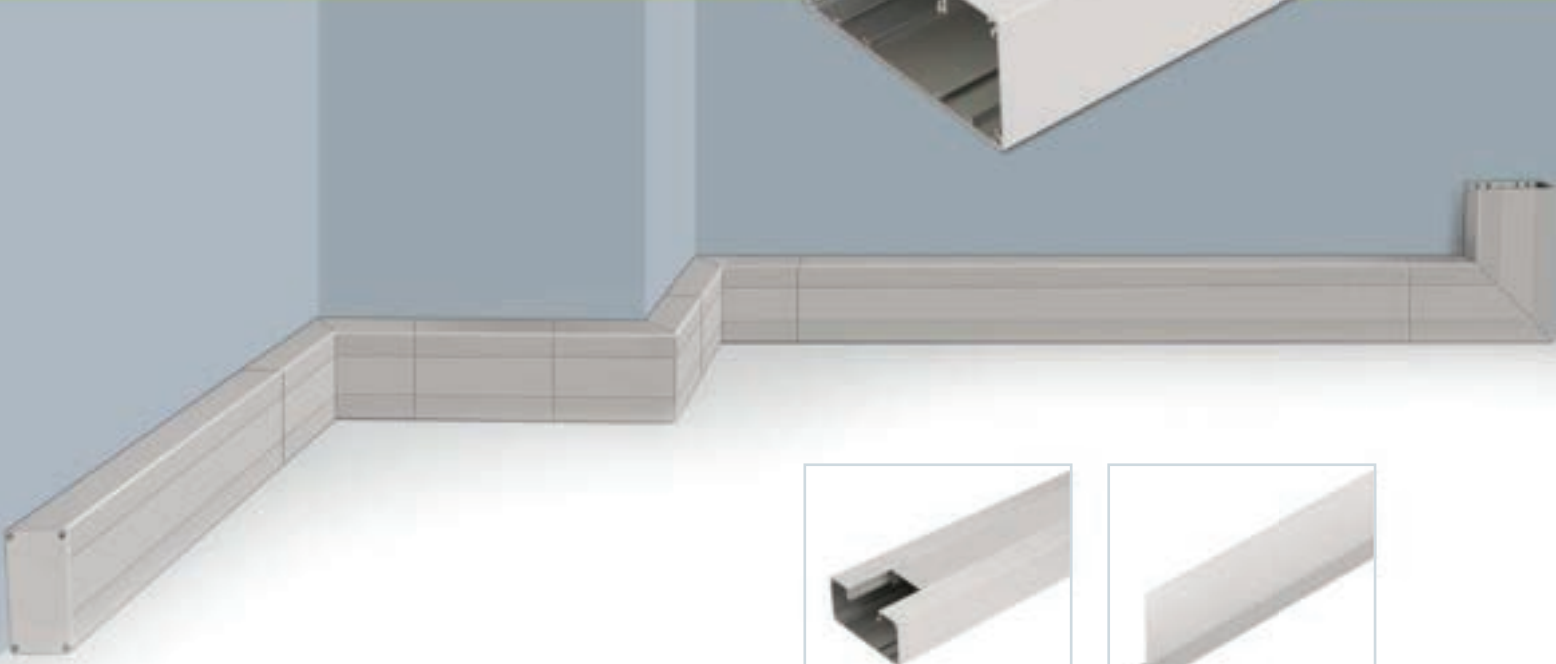
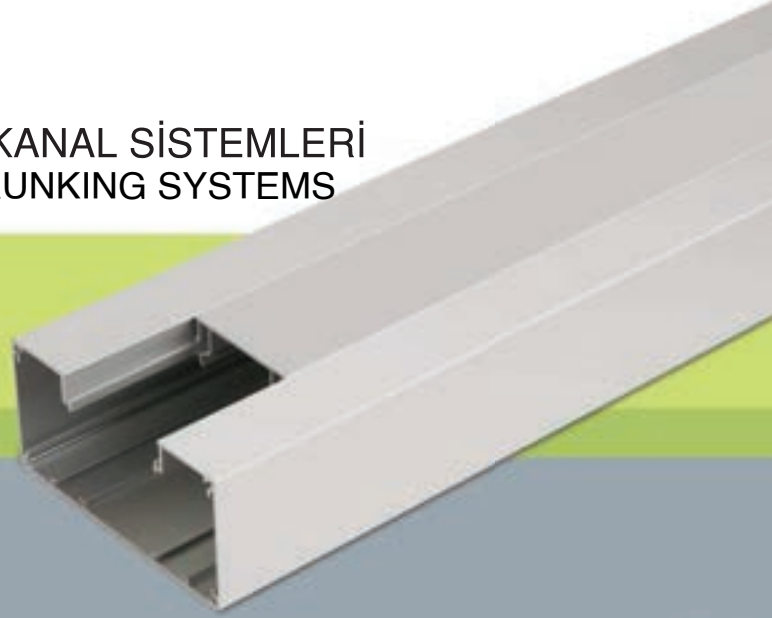

104 50

Ambalaj: 16 m
104x50 Alüminyum Kablo Kanalı
Packaging: 16 m
Aluminium Cable Trunking

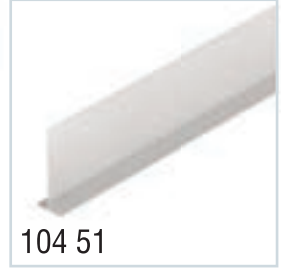

104 51

Ambalaj: 50m
Ara bölme Uzunluk 2m
Packaging: 50m
Divider 2m length



104 01

İç Köşe
Internal Corner



104 02

Dış Köşe
External Corner



104 03

Dirsek 90°
90° Corner Piece



104 04

T Dirsek
T Corner



104 05

Sonlandırma Kapağı
End Cover



104 08

Birleştirme Parçası
Junction Piece



104 09

Yatay Birleştirme Parçası
Horizontal Junction Piece



104 10

Dikey Birleştirme Parçası
Vertical Junction Piece

Kanal üzerine çerçevesiz direk priz montajı

Frameless socket assembling on cable trunking (Direct socket assembling)

DÖŞEME ÜSTÜ ALUMİNYUM KABLO KANALLARI OVERFLOOR ALUMINIUM CABLE TRUNKS



900 22

90x20

Aluminyum Kanal / Aluminium Trunk
Uzunluk 2m / Length 2m
Ambalaj: 24m / Packaging: 24m
Kesit 90x20mm / Size 90x20mm
Kapaklı Satılır / Complete with cover



906 22

90x20

Aluminyum Kanal / Aluminium Trunk
Uzunluk 2m / Length 2m
Ambalaj: 24m / Packaging: 24m
Kesit 90x20mm / Size 90x20mm
Kapaklı Satılır / Complete with cover

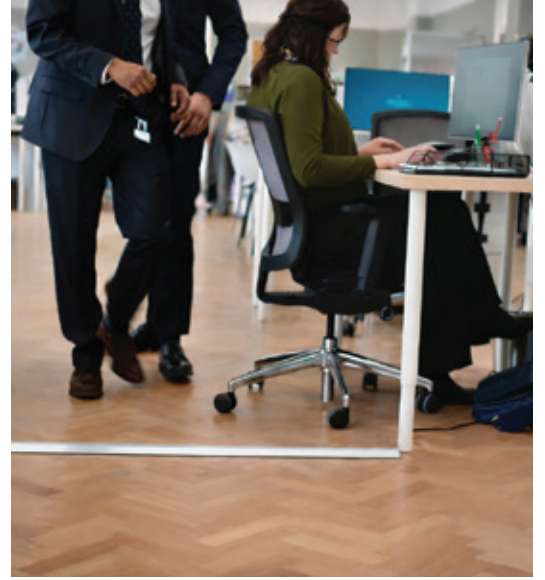
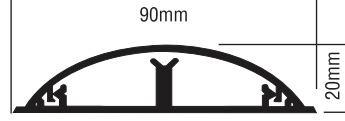

600 15

60x15

Aluminyum Kanal / Aluminium Trunk
Uzunluk 2m / Length 2m
Ambalaj: 30m / Packaging: 30m
Kesit 60x15mm / Size 60x15mm
Kapaklı Satılır / Complete with cover



606 15

60x15

Aluminyum Kanal / Aluminium Trunk
Uzunluk 2m / Length 2m
Ambalaj: 30m / Packaging: 30m
Kesit 60x15mm / Size 60x15mm
Kapaklı Satılır / Complete with cover

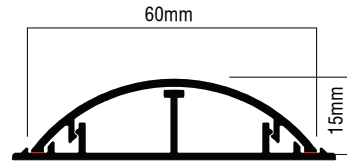

ALUMİNYUM KABLO KANALLARI ALUMINIUM CABLE TRUNKS



1100 01

65x52

Aluminyum Kanal / Aluminium Trunk
Uzunluk 2m / Length 2m
Ambalaj: 30m / Packaging: 30m
Kesit 65x52mm / Size 65x52mm
Kapaklı Satılır / Complete with cover

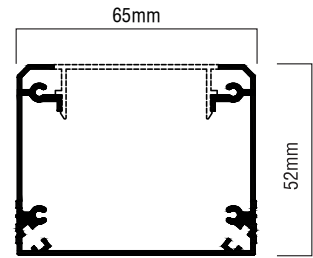

1100 02

102x55

Aluminyum Kanal / Aluminium Trunk
Uzunluk 2m / Length 2m
Ambalaj: 12m / Packaging: 12m
Kesit 102x55mm / Size 102x55mm
Kapaklı Satılır / Complete with cover

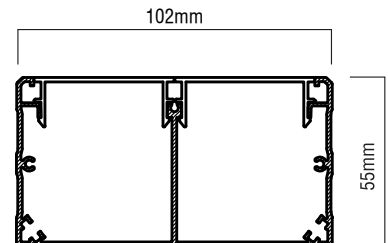

kaidesiz 45x45 mm direkt priz
montajına uygun çözümler

*Wide product range offering solutions for
frameless direct socket installation*





EKO BEST SERİ KABLO KANALLARI
ECO BEST LINE CABLE TRUNKING



EKO BEST SERİ KABLO KANALLARI ve AKSESUARLARI / ECO BEST LINE CABLE TRUNKING & ACCESSORIES

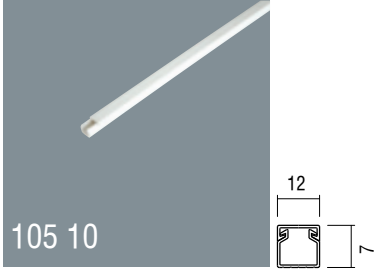

105 10

10x10
PVC Kablo Kanalı
Kapaklı Satılır
Ambalaj: 340m / 170 Boy
10x10 PVC Cable Trunking
Complete with cover
Packaging: 340m / 170 Pcs

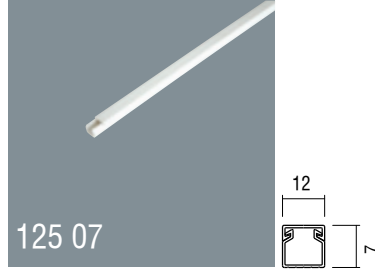

125 07

12x7
PVC Kablo Kanalı
Kapaklı Satılır
Ambalaj: 340m / 170 Boy
12x7 PVC Cable Trunking
Complete with cover
Packaging: 340m / 170 Pcs

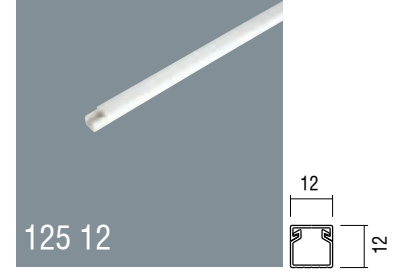

125 12

12x12
PVC Kablo Kanalı
Kapaklı Satılır
Ambalaj: 340m / 170 Boy
12x12 PVC Cable Trunking
Complete with cover
Packaging: 340m / 170 Pcs

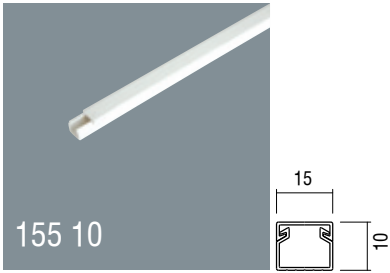

155 10

15x10
PVC Kablo Kanalı
Kapaklı Satılır
Ambalaj: 364m / 182 Boy
15x10 PVC Cable Trunking
Complete with cover
Packaging: 364m / 182 Pcs

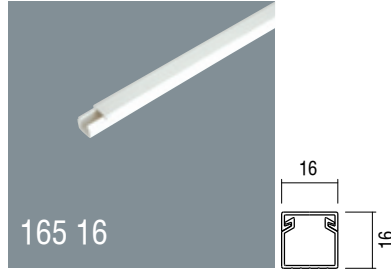

165 16

16x16
PVC Kablo Kanalı
Kapaklı Satılır
Ambalaj: 192m / 96 Boy
16x16 PVC Cable Trunking
Complete with cover
Packaging: 192m / 96 Pcs

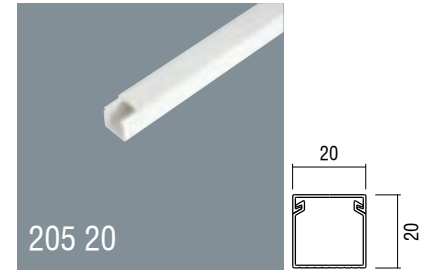

205 20

20x20
PVC Kablo Kanalı
Kapaklı Satılır
Ambalaj: 260m / 130 Boy
20x20 PVC Cable Trunking
Complete with cover
Packaging: 260m / 130 Pcs

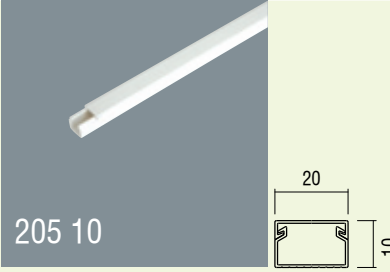

205 10

20x10
PVC Kablo Kanalı
Kapaklı Satılır
Ambalaj: 260m / 130 Boy
20x10 PVC Cable Trunking
Complete with cover
Packaging: 260m / 130 Pcs



205 01

Ambalaj: 10 Adet
İç Köşe
Packaging: 10 pcs
Internal Corner

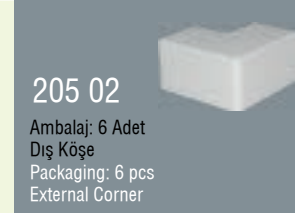

205 02

Ambalaj: 6 Adet
Dış Köşe
Packaging: 6 pcs
External Corner



205 03

Ambalaj: 6 Adet
Dirsek 90°
Packaging: 6 pcs
90 Corner Piece



205 04

Ambalaj: 8 Adet
T Dirsek
Packaging: 8 pcs
T Corner



205 05

Ambalaj: 20 Adet
Sonlandırma Kapağı
Packaging: 20 pcs
End Cover



205 06

Ambalaj: 20 Adet
Kanal Birleştirme Parçası
Packaging: 20 pcs
Junction Piece

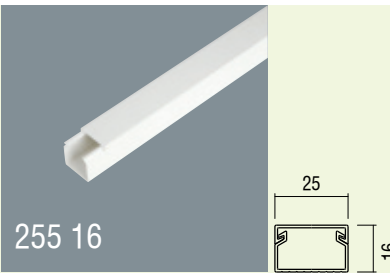

255 16

25x16
PVC Kablo Kanalı
Kapaklı Satılır
Ambalaj: 128m / 64 Boy
25x16 PVC Cable Trunking
Complete with cover
Packaging: 128m / 64 Pcs



255 01

Ambalaj: 10 Adet
İç Köşe
Packaging: 10 pcs
Internal Corner



255 02

Ambalaj: 6 Adet
Dış Köşe
Packaging: 6 pcs
External Corner



255 03

Ambalaj: 6 Adet
Dirsek 90°
Packaging: 6 pcs
90 Corner Piece



255 04

Ambalaj: 8 Adet
T Dirsek
Packaging: 8 pcs
T Corner

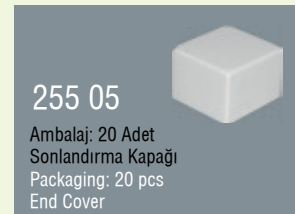

255 05

Ambalaj: 20 Adet
Sonlandırma Kapağı
Packaging: 20 pcs
End Cover



255 06

Ambalaj: 20 Adet
Kanal Birleştirme Parçası
Packaging: 20 pcs
Junction Piece

EKO BEST SERİ KABLO KANALLARI ve AKSESUARLARI / ECO BEST LINE CABLE TRUNKING & ACCESSORIES

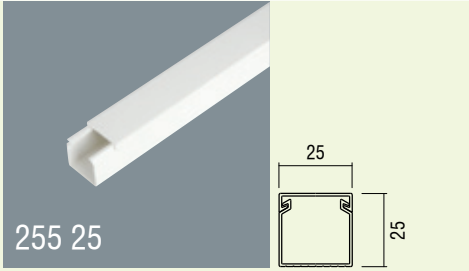

255 25

25x25

PVC Kablo Kanalı
Kapaklı Satılır
Ambalaj: 80m / 40 Boy
25x25 PVC Cable Trunking
Complete with cover
Packaging: 80m / 40 Pcs



255 01

Ambalaj: 10 Adet
İç Köşe
Packaging: 10 pcs
Internal Corner

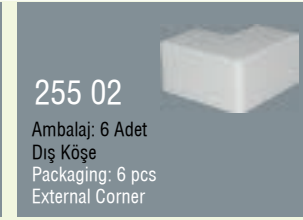

255 02

Ambalaj: 6 Adet
Dış Köşe
Packaging: 6 pcs
External Corner



255 03

Ambalaj: 6 Adet
Dirsek 90°
Packaging: 6 pcs
90 Corner Piece



255 04

Ambalaj: 8 Adet
T Dirsek
Packaging: 8pcs
T Corner

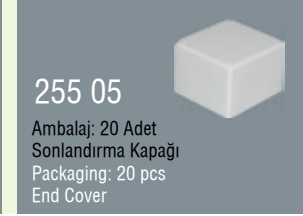

255 05

Ambalaj: 20 Adet
Sonlandırma Kapağı
Packaging: 20 pcs
End Cover



255 06

Ambalaj: 20 Adet
Kanal Birleştirme Parçası
Packaging: 20 pcs
Junction Piece

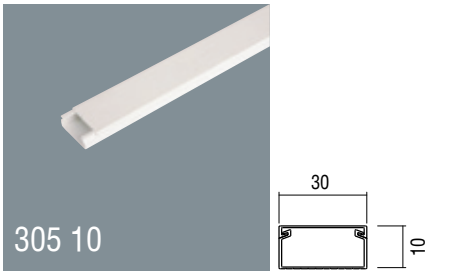

305 10

30x10

PVC Kablo Kanalı
Kapaklı Satılır
Ambalaj: 168m / 84 Boy
30x10 PVC Cable Trunking
Complete with cover
Packaging: 168m / 84 Pcs



305 10

30x10

PVC Kablo Kanalı
Kapaklı Satılır
Ambalaj: 168m / 84 Boy
30x10 PVC Cable Trunking
Complete with cover, self divider
Packaging: 168m / 84 Pcs

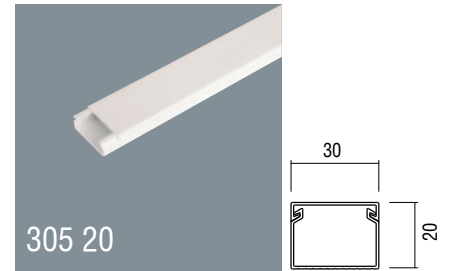

305 20

30x20

PVC Kablo Kanalı
Kapaklı Satılır
Ambalaj: 84m / 42 Boy
30x20 PVC Cable Trunking
Complete with cover
Packaging: 84m / 42 Pcs

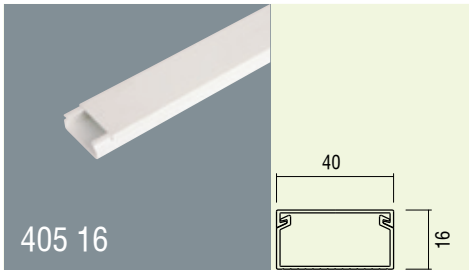

405 16

40x16

PVC Kablo Kanalı
Kapaklı Satılır
Ambalaj: 60m / 30 Boy
40x16 PVC Cable Trunking
Complete with cover
Packaging: 60m / 30 Pcs



405 01

Ambalaj: 10 Adet
İç Köşe
Packaging: 10 pcs
Internal Corner

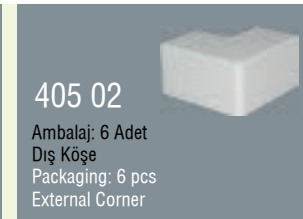

405 02

Ambalaj: 6 Adet
Dış Köşe
Packaging: 6 pcs
External Corner



405 03

Ambalaj: 6 Adet
Dirsek 90°
Packaging: 6 pcs
90 Corner Piece



405 04

Ambalaj: 8 Adet
T Dirsek
Packaging: 8pcs
T Corner



405 05

Ambalaj: 20 Adet
Sonlandırma Kapağı
Packaging: 20 pcs
End Cover



405 06

Ambalaj: 20 Adet
Kanal Birleştirme Parçası
Packaging: 20 pcs
Junction Piece

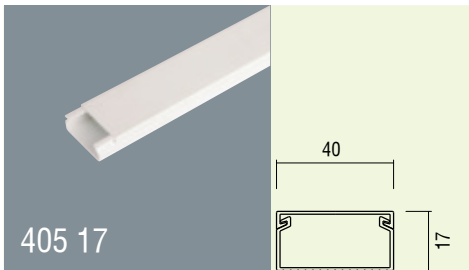

405 17

40x17

PVC Kablo Kanalı
Kapaklı Satılır
Ambalaj: 60m / 30 Boy
40x17 PVC Cable Trunking
Complete with cover
Packaging: 60m / 30 Pcs



405 01

Ambalaj: 10 Adet
İç Köşe
Packaging: 10 pcs
Internal Corner

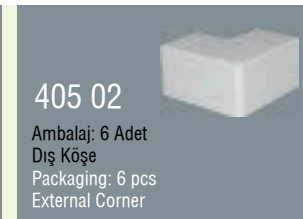

405 02

Ambalaj: 6 Adet
Dış Köşe
Packaging: 6 pcs
External Corner



405 03

Ambalaj: 6 Adet
Dirsek 90°
Packaging: 6 pcs
90 Corner Piece

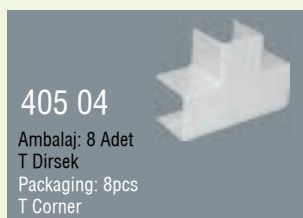

405 04

Ambalaj: 8 Adet
T Dirsek
Packaging: 8pcs
T Corner

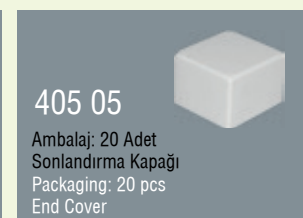

405 05

Ambalaj: 20 Adet
Sonlandırma Kapağı
Packaging: 20 pcs
End Cover

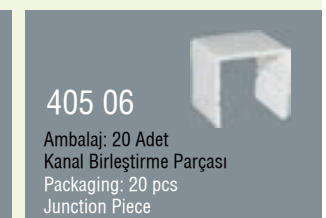

405 06

Ambalaj: 20 Adet
Kanal Birleştirme Parçası
Packaging: 20 pcs
Junction Piece

EKO BEST SERİ KABLO KANALLARI ve AKSESUARLARI / ECO BEST LINE CABLE TRUNKING & ACCESSORIES

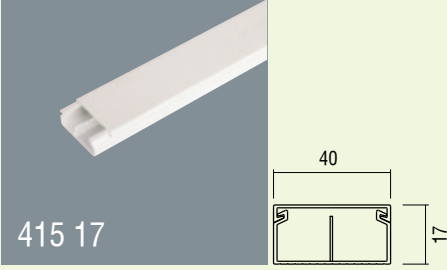

415 17

40x17
PVC Kablo Kanalı Ara Bölmeli
Kapaklı Satılır
Ambalaj: 60m / 30 Boy
40x17 PVC Cable Trunking
Complete with cover,
Packaging: 60m / 30 Pcs

405 01

Ambalaj: 10 Adet
İç Köşe
Packaging: 10 pcs
Internal Corner



405 02

Ambalaj: 6 Adet
Dış Köşe
Packaging: 6 pcs
External Corner



405 03

Ambalaj: 6 Adet
Dirsek 90°
Packaging: 6 pcs
90 Corner Piece



405 04

Ambalaj: 8 Adet
T Dirsek
Packaging: 8pcs
T Corner



405 05

Ambalaj: 20 Adet
Sonlandırma Kapağı
Packaging: 20 pcs
End Cover



405 06

Ambalaj: 20 Adet
Kanal Birleştirme Parçası
Packaging: 20 pcs
Junction Piece

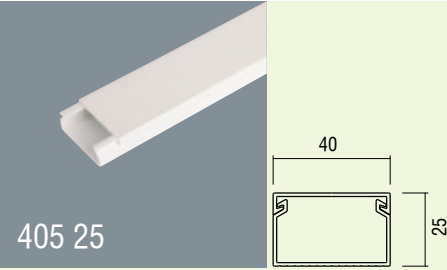

405 25

40x25
PVC Kablo Kanalı
Kapaklı Satılır
Ambalaj: 50m / 25 Boy
40x25 PVC Cable Trunking
Complete with cover
Packaging: 50m / 25 Pcs

405 01

Ambalaj: 10 Adet
İç Köşe
Packaging: 10 pcs
Internal Corner



405 02

Ambalaj: 6 Adet
Dış Köşe
Packaging: 6 pcs
External Corner



405 03

Ambalaj: 6 Adet
Dirsek 90°
Packaging: 6 pcs
90 Corner Piece



405 04

Ambalaj: 8 Adet
T Dirsek
Packaging: 8pcs
T Corner



405 05

Ambalaj: 20 Adet
Sonlandırma Kapağı
Packaging: 20 pcs
End Cover



405 06

Ambalaj: 20 Adet
Kanal Birleştirme Parçası
Packaging: 20 pcs
Junction Piece

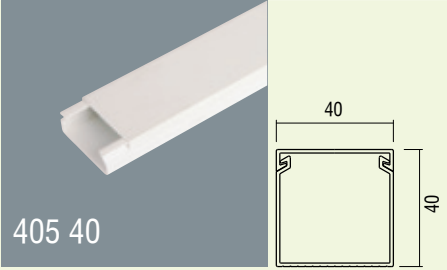

405 40

40x40
PVC Kablo Kanalı
Kapaklı Satılır
Ambalaj: 48m / 24 Boy
40x40 PVC Cable Trunking
Complete with cover
Packaging: 48m / 24 Pcs

405 01

Ambalaj: 10 Adet
İç Köşe
Packaging: 10 pcs
Internal Corner



405 02

Ambalaj: 6 Adet
Dış Köşe
Packaging: 6 pcs
External Corner



405 03

Ambalaj: 6 Adet
Dirsek 90°
Packaging: 6 pcs
90 Corner Piece



405 04

Ambalaj: 8 Adet
T Dirsek
Packaging: 8pcs
T Corner



405 05

Ambalaj: 20 Adet
Sonlandırma Kapağı
Packaging: 20 pcs
End Cover



405 06

Ambalaj: 20 Adet
Kanal Birleştirme Parçası
Packaging: 20 pcs
Junction Piece

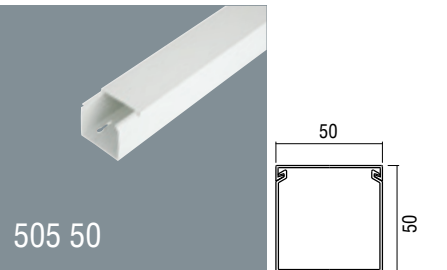

505 50

50x50
PVC Kablo Kanalı
Kapaklı Satılır
Ambalaj: 36m / 18 Boy
50x50 PVC Cable Trunking
Complete with cover
Packaging: 36m / 18 Pcs

605 25

60x25
PVC Kablo Kanalı
Kapaklı Satılır
Ambalaj: 48m / 24 Boy
60x25 PVC Cable Trunking
Complete with cover
Packaging: 48m / 24 Pcs

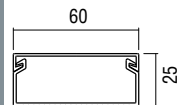

605 40

60x40
PVC Kablo Kanalı
Kapaklı Satılır
Ambalaj: 36m / 18 Boy
60x40 PVC Cable Trunking
Complete with cover
Packaging: 36m / 18 Pcs

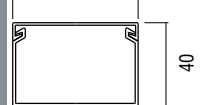

EKO BEST SERİ KABLO KANALLARI ve AKSESUARLARI / ECO BEST LINE CABLE TRUNKING & ACCESSORIES



605 60

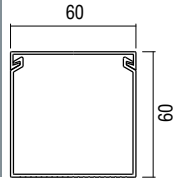

60x60
PVC Kablo Kanalı
Kapaklı Satılır
Ambalaj: 24m / 12 Boy
60x60 PVC Cable Trunking
Complete with cover
Packaging: 24m / 12 Pcs



805 41

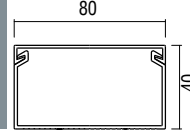

80x40
PVC Kablo Kanalı
Kapaklı Satılır
Ambalaj: 28m / 14 Boy
80x40 PVC Cable Trunking
Complete with cover
Packaging: 28m / 14 Pcs



805 60

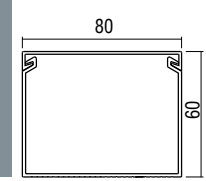

80x60
PVC Kablo Kanalı
Kapaklı Satılır
Ambalaj: 24m / 12 Boy
80x60 PVC Cable Trunking
Complete with cover
Packaging: 24m / 12 Pcs



105 40

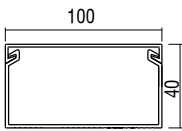

100x40
PVC Kablo Kanalı
Kapaklı Satılır
Ambalaj: 20m / 10 Boy
100x40 PVC Cable Trunking
Complete with cover
Packaging: 20m / 10 Pcs



105 60

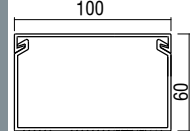

100x60
PVC Kablo Kanalı
Kapaklı Satılır
Ambalaj: 16m / 8 Boy
100x60 PVC Cable Trunking
Complete with cover
Packaging: 16m / 8 Pcs



125 60

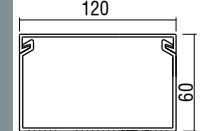

120x60
PVC Kablo Kanalı
Kapaklı Satılır
Ambalaj: 16m / 8 Boy
120x60 PVC Cable Trunking
Complete with cover
Packaging: 16m / 8 Pcs

BOYALI EKO BEST SERİ KABLO KANALLARI PAINTING ECO BEST LINE CABLE TRUNKING

16x16 • 25x16 • 25x25

40x25 • 102x50

Kanal Ebatlarımızı

istediğiniz renk seçeneklerinde
boyanabilir.

16x16 • 25x16 • 25x25

40x25 • 102x50

Sizes can be painted with
the color you choose

Huş
Birch

Meşe
Oak

Ceviz
Walnut

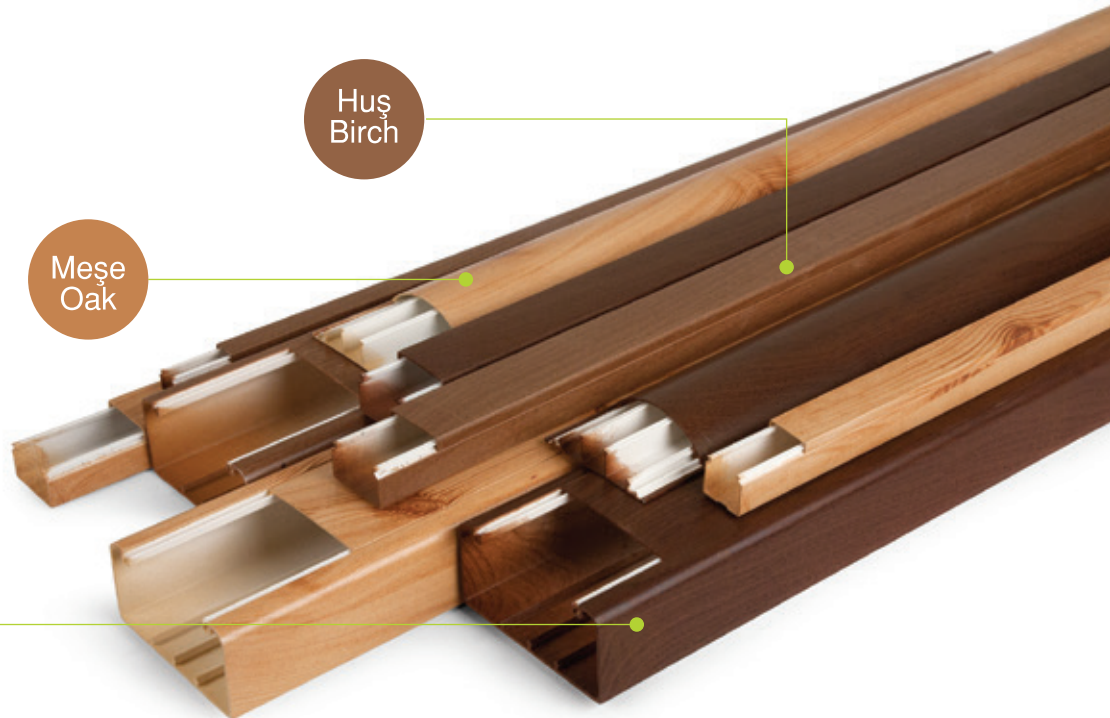

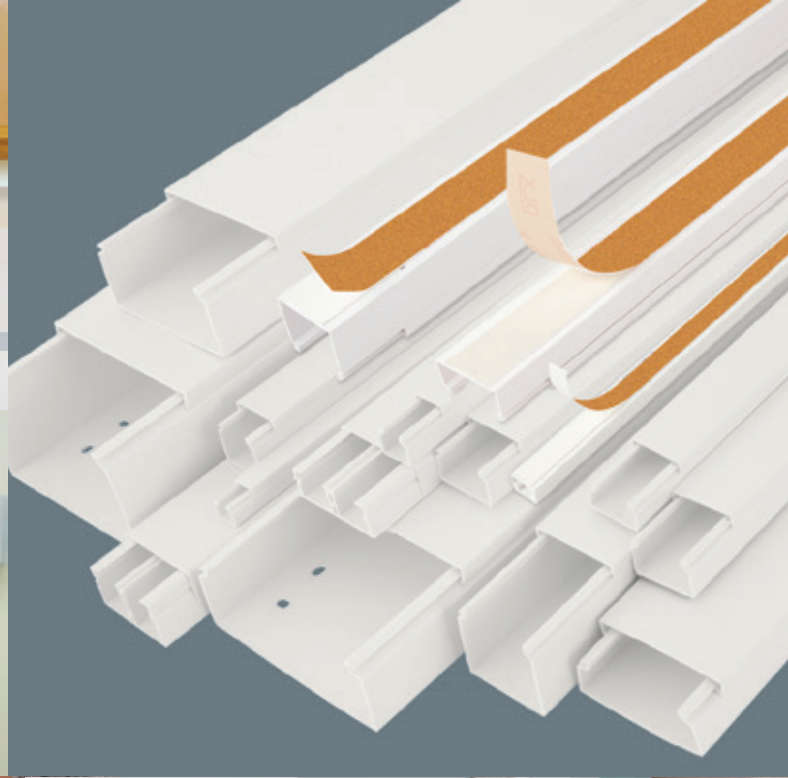

EKO BEST SERİ KENDİNDEN YAPIŞKANLI KABLO KANALLARI
ECO BEST LINE SELF ADHESIVE CABLE TRUNKINGS

EKO BEST SERİ KENDİNDEN YAPIŞKANLI KABLO KANALLARI ve AKSESUARLARI
ECO BEST LINE SELF ADHESIVE CABLE TRUNKINGS & ACCESSORIES

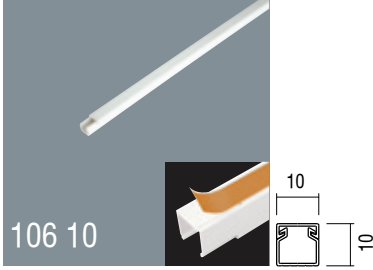

106 10

10x10

PVC Yapışkan Bantlı Kablo Kanalı
Kapaklı Satılır
Ambalaj: 340m / 170 Boy
10x10 Self Adhesive PVC Cable Trunking
With cover
Packaging: 340m / 170 Pcs

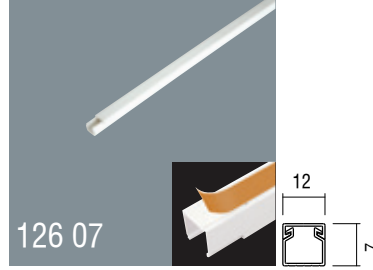

126 07

12x7

PVC Yapışkan Bantlı Kablo Kanalı
Kapaklı Satılır
Ambalaj: 340m / 170 Boy
12x7 Self Adhesive PVC Cable Trunking
With cover
Packaging: 340m / 170 Pcs

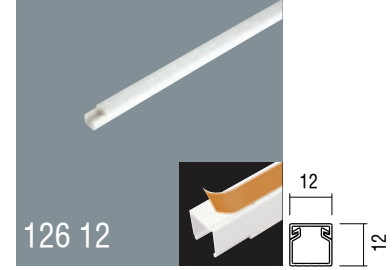

126 12

12x12

PVC Yapışkan Bantlı Kablo Kanalı
Kapaklı Satılır
Ambalaj: 340m / 170 Boy
12x12 Self Adhesive PVC Cable Trunking
With cover
Packaging: 340m / 170 Pcs

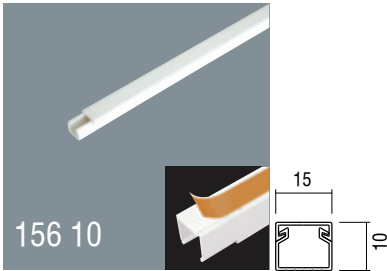

156 10

15x10

PVC Yapışkan Bantlı Kablo Kanalı
Kapaklı Satılır
Ambalaj: 364m / 182 Boy
15x10 Self Adhesive PVC Cable Trunking
With cover
Packaging: 364m / 182 Pcs

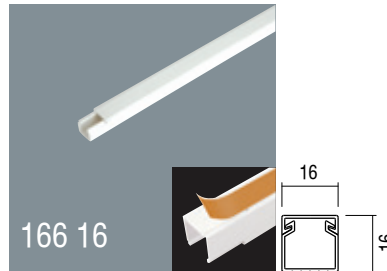

166 16

16x16

PVC Yapışkan Bantlı Kablo Kanalı
Kapaklı Satılır
Ambalaj: 192m / 96 Boy
16x16 Self Adhesive PVC Cable Trunking
With cover
Packaging: 192m / 96 Pcs

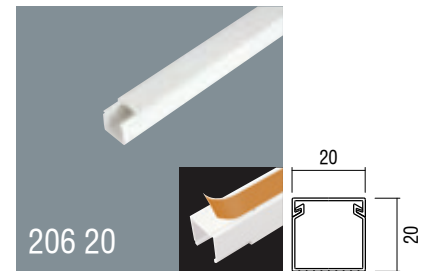

206 20

20x20

PVC Kablo Kanalı
Kapaklı Satılır
Ambalaj: 260m / 130 Boy
20x20 PVC Cable Trunking
Complete with cover
Packaging: 260m / 130 Pcs

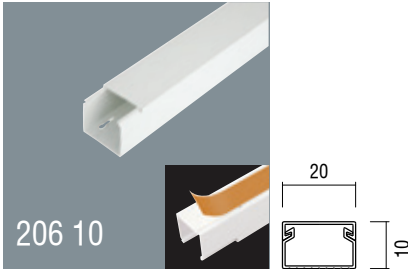

206 10

20x10

PVC Yapışkan Bantlı Kablo Kanalı
Kapaklı Satılır
Ambalaj: 260m / 130 Boy
20x10 Self Adhesive PVC Cable Trunking
With cover
Packaging: 260m / 130 Pcs

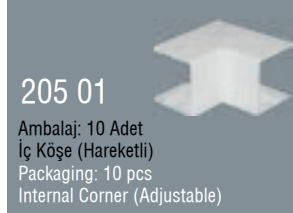

205 01

Ambalaj: 10 Adet
İç Köşe (Hareketli)
Packaging: 10 pcs
Internal Corner (Adjustable)

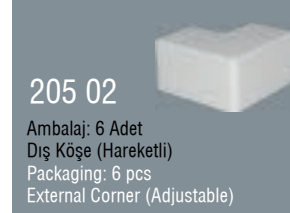

205 02

Ambalaj: 6 Adet
Dış Köşe (Hareketli)
Packaging: 6 pcs
External Corner (Adjustable)

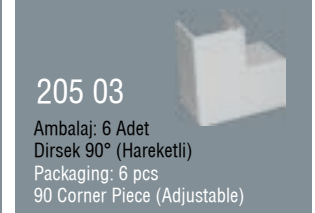

205 03

Ambalaj: 6 Adet
Dirsek 90° (Hareketli)
Packaging: 6 pcs
90 Corner Piece (Adjustable)



205 04

Ambalaj: 8 Adet
T Dirsek
Packaging: 8 pcs
T Corner



205 05

Ambalaj: 20 Adet
Sonlandırma Kapağı
Packaging: 20 pcs
End Cover



205 06

Ambalaj: 20 Adet
Kanal Birleştirme Parçası
Packaging: 20 pcs
Junction Piece

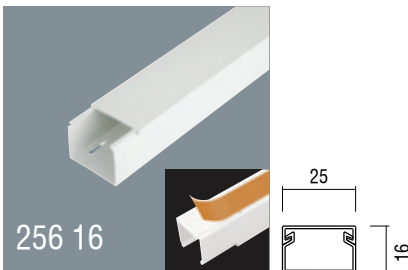

256 16

25x16

PVC Yapışkan Bantlı Kablo Kanalı
Kapaklı Satılır
Ambalaj: 128m / 64 Boy
25x16 Self Adhesive PVC Cable Trunking
With cover
Packaging: 128m / 64 Pcs



255 01

Ambalaj: 10 Adet
İç Köşe (Hareketli)
Packaging: 10 pcs
Internal Corner (Adjustable)

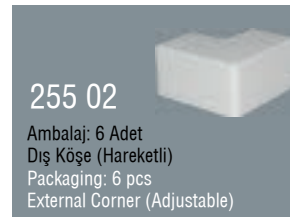

255 02

Ambalaj: 6 Adet
Dış Köşe (Hareketli)
Packaging: 6 pcs
External Corner (Adjustable)

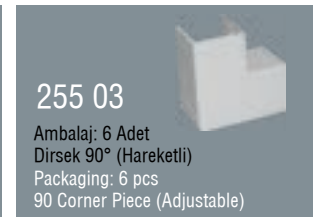

255 03

Ambalaj: 6 Adet
Dirsek 90° (Hareketli)
Packaging: 6 pcs
90 Corner Piece (Adjustable)



255 04

Ambalaj: 8 Adet
T Dirsek
Packaging: 8 pcs
T Corner



255 05

Ambalaj: 20 Adet
Sonlandırma Kapağı
Packaging: 20 pcs
End Cover



255 06

Ambalaj: 20 Adet
Kanal Birleştirme Parçası
Packaging: 20 pcs
Junction Piece

EKO BEST SERİ KENDİNDEN YAPIŞKANLI KABLO KANALLARI ve AKSESUARLARI
ECO BEST LINE SELF ADHESIVE CABLE TRUNKINGS & ACCESSORIES

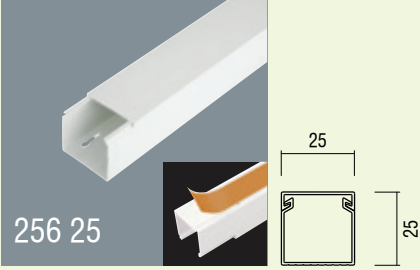

256 25

25x25

PVC Yapışkan Bantlı Kablo Kanalı
Kapaklı Satılır
Ambalaj: 80m / 40 Boy
25x25 Self Adhesive PVC Cable Trunking
With cover
Packaging: 80m / 40 Pcs



255 01

Ambalaj: 10 Adet
İç Köşe (Hareketli)
Packaging: 10 pcs
Internal Corner (Adjustable)



255 02

Ambalaj: 6 Adet
Dış Köşe (Hareketli)
Packaging: 6 pcs
External Corner (Adjustable)



255 03

Ambalaj: 6 Adet
Dirsek 90° (Hareketli)
Packaging: 6 pcs
90 Corner Piece (Adjustable)



255 04

Ambalaj: 8 Adet
T Dirsek
Packaging: 8pcs
T Corner

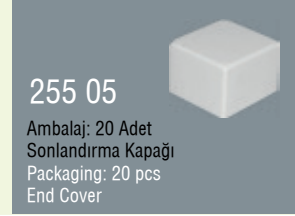

255 05

Ambalaj: 20 Adet
Sonlandırma Kapağı
Packaging: 20 pcs
End Cover



255 06

Ambalaj: 20 Adet
Kanal Birleştirme Parçası
Packaging: 20 pcs
Junction Piece

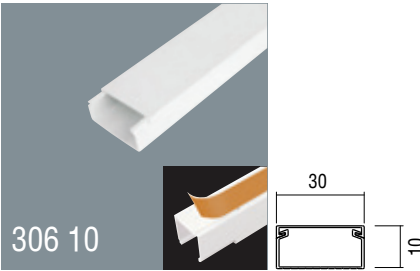

306 10

30x10

PVC Yapışkan Bantlı Kablo Kanalı
Kapaklı Satılır
Ambalaj: 168m / 84 Boy
30x10 PVC Cable Trunking
Complete with cover
Packaging: 168m / 84 Pcs

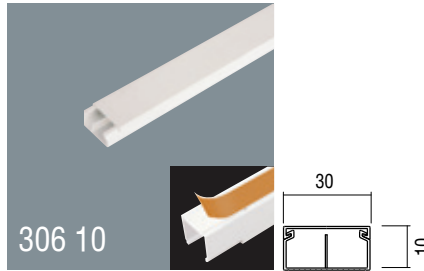

306 10

30x10

PVC Yapışkan Bantlı Kablo Kanalı Bölmeli
Kapaklı Satılır
Ambalaj: 168m / 84 Boy
30x10 Self Adhesive PVC Cable Trunking
with cover, self divider
Packaging: 168m / 84 Pcs

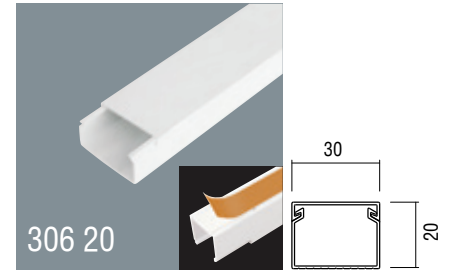

306 20

30x20

PVC Yapışkan Bantlı Kablo Kanalı
Kapaklı Satılır
Ambalaj: 84m / 42 Boy
30x20 PVC Cable Trunking
Complete with cover
Packaging: 84m / 42 Pcs

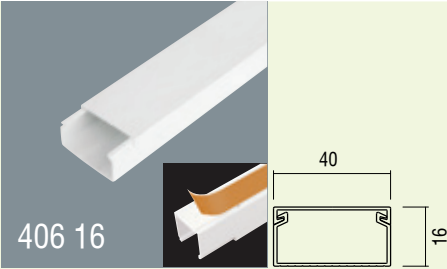

406 16

40x16

PVC Yapışkan Bantlı Kablo Kanalı
Kapaklı Satılır
Ambalaj: 60m / 30 Boy
40x16 PVC Cable Trunking
Complete with cover
Packaging: 60m / 30 Pcs

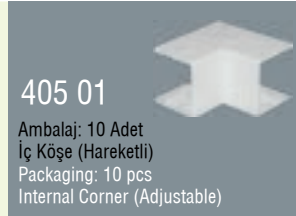

405 01

Ambalaj: 10 Adet
İç Köşe (Hareketli)
Packaging: 10 pcs
Internal Corner (Adjustable)

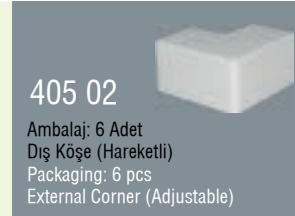

405 02

Ambalaj: 6 Adet
Dış Köşe (Hareketli)
Packaging: 6 pcs
External Corner (Adjustable)

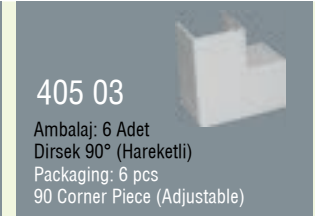

405 03

Ambalaj: 6 Adet
Dirsek 90° (Hareketli)
Packaging: 6 pcs
90 Corner Piece (Adjustable)



405 04

Ambalaj: 8 Adet
T Dirsek
Packaging: 8pcs
T Corner



405 05

Ambalaj: 20 Adet
Sonlandırma Kapağı
Packaging: 20 pcs
End Cover



405 06

Ambalaj: 20 Adet
Kanal Birleştirme Parçası
Packaging: 20 pcs
Junction Piece

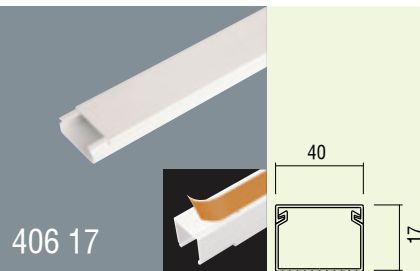

406 17

40x17

PVC Yapışkan Bantlı Kablo Kanalı
Kapaklı Satılır
Ambalaj: 60m / 30 Boy
40x17 Self Adhesive PVC Cable Trunking
With cover
Packaging: 60m / 30 Pcs



405 01

Ambalaj: 10 Adet
İç Köşe
Packaging: 10 pcs
Internal Corner



405 02

Ambalaj: 6 Adet
Dış Köşe
Packaging: 6 pcs
External Corner



405 03

Ambalaj: 6 Adet
Dirsek 90°
Packaging: 6 pcs
90 Corner Piece



405 04

Ambalaj: 8 Adet
T Dirsek
Packaging: 8pcs
T Corner



405 05

Ambalaj: 20 Adet
Sonlandırma Kapağı
Packaging: 20 pcs
End Cover



405 06

Ambalaj: 20 Adet
Kanal Birleştirme Parçası
Packaging: 20 pcs
Junction Piece

EKO BEST SERİ KENDİNDEN YAPILANLI KABLO KANALLARI ve AKSESUARLARI
ECO BEST LINE SELF ADHESIVE CABLE TRUNKINGS & ACCESSORIES

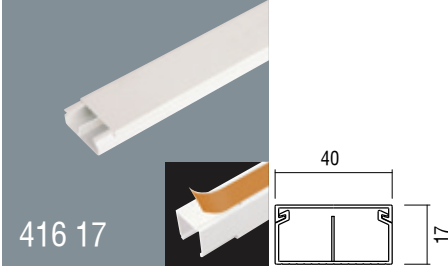

416 17

40x17

PVC Yapışkan Bantlı Kablo Kanalı Bölmeli Kapaklı Satılır
Ambalaj: 60m / 30 Boy
40x17 PVC Cable Trunking
Complete with cover, self divider
Packaging: 60m / 30 Pcs



405 01

Ambalaj: 10 Adet
İç Köşe
Packaging: 10 pcs
Internal Corner



405 02

Ambalaj: 6 Adet
Dış Köşe
Packaging: 6 pcs
External Corner



405 03

Ambalaj: 6 Adet
Dirsek 90°
Packaging: 6 pcs
90 Corner Piece



405 04

Ambalaj: 8 Adet
T Dirsek
Packaging: 8pcs
T Corner

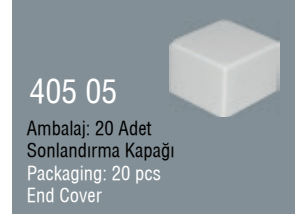

405 05

Ambalaj: 20 Adet
Sonlandırma Kapağı
Packaging: 20 pcs
End Cover



405 06

Ambalaj: 20 Adet
Kanal Birleştirme Parçası
Packaging: 20 pcs
Junction Piece

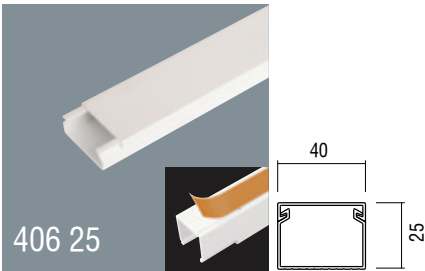

406 25

40x25

PVC Yapışkan Bantlı Kablo Kanalı Kapaklı Satılır
Ambalaj: 50m / 25 Boy
40x25 Self Adhesive PVC Cable Trunking
With cover
Packaging: 50m / 25 Pcs



405 01

Ambalaj: 10 Adet
İç Köşe
Packaging: 10 pcs
Internal Corner



405 02

Ambalaj: 6 Adet
Dış Köşe
Packaging: 6 pcs
External Corner



405 03

Ambalaj: 6 Adet
Dirsek 90°
Packaging: 6 pcs
90 Corner Piece



405 04

Ambalaj: 8 Adet
T Dirsek
Packaging: 8pcs
T Corner



405 05

Ambalaj: 20 Adet
Sonlandırma Kapağı
Packaging: 20 pcs
End Cover



405 06

Ambalaj: 20 Adet
Kanal Birleştirme Parçası
Packaging: 20 pcs
Junction Piece

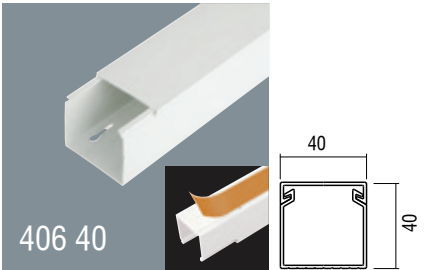

406 40

40x40

PVC Yapışkan Bantlı Kablo Kanalı Kapaklı Satılır
Ambalaj: 48m / 24 Boy
40x40 Self Adhesive PVC Cable Trunking
With cover
Packaging: 48m / 24 Pcs



405 01

Ambalaj: 10 Adet
İç Köşe
Packaging: 10 pcs
Internal Corner



405 02

Ambalaj: 6 Adet
Dış Köşe
Packaging: 6 pcs
External Corner



405 03

Ambalaj: 6 Adet
Dirsek 90°
Packaging: 6 pcs
90 Corner Piece



405 04

Ambalaj: 8 Adet
T Dirsek
Packaging: 8pcs
T Corner



405 05

Ambalaj: 20 Adet
Sonlandırma Kapağı
Packaging: 20 pcs
End Cover



405 06

Ambalaj: 20 Adet
Kanal Birleştirme Parçası
Packaging: 20 pcs
Junction Piece

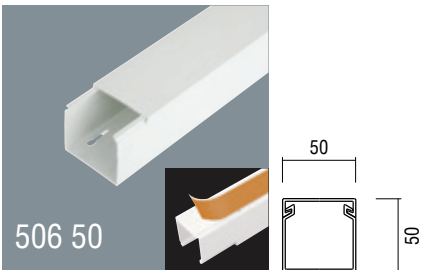

506 50

50x50

PVC Yapışkan Bantlı Kablo Kanalı Kapaklı Satılır
Ambalaj: 36m / 18 Boy
50x50 Self Adhesive PVC Cable Trunking
With cover
Packaging: 36m / 18 Pcs

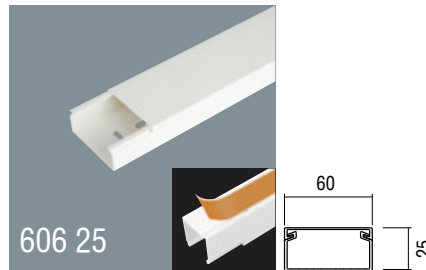

606 25

60x25

PVC Kablo Kanalı Kapaklı Satılır
Ambalaj: 48m / 24 Boy
30x10 PVC Cable Trunking
Complete with cover
Packaging: 60m / 25 Pcs

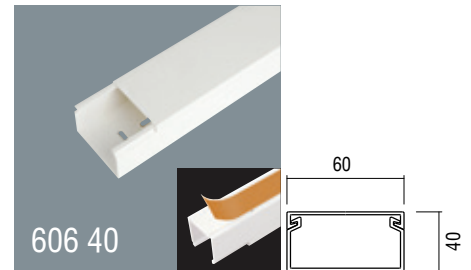

606 40

60x40

PVC Kablo Kanalı Bölmesiz Kapaklı Satılır
Ambalaj: 36m / 18 Boy
60x40 PVC Cable Trunking
Complete with cover
Packaging: 60m / 30 Pcs



CANAFIX SERİ KABLO KANALLARI
CANAFIX LINE CABLE TRUNKINGS

CANAFIX SERİ KABLO KANALLARI ve AKSESUARLARI / CANAFIX LINE CABLE TRUNKING & ACCESSORIES

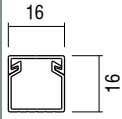

161 16

16x16

PVC Kablo Kanalı
Kapaklı Satılır

Ambalaj: 192m / 96 Boy

16x16 PVC Cable Trunking
Complete with cover
Packaging: 192m / 96 Pcs

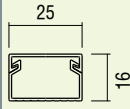

251 16

25x16

PVC Kablo Kanalı
Kapaklı Satılır

Ambalaj: 128m / 64 Boy

25x16 PVC Cable Trunking
Complete with cover
Packaging: 128m / 64 Pcs



255 01

Ambalaj: 10 Adet
İç Köşe
Packaging: 10 pcs
Internal Corner



255 02

Ambalaj: 6 Adet
Dış Köşe
Packaging: 6 pcs
External Corner



255 03

Ambalaj: 6 Adet
Dirsek 90°
Packaging: 6 pcs
90 Corner Piece

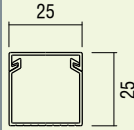

251 25

25x25

PVC Kablo Kanalı
Kapaklı Satılır

Ambalaj: 80m / 40 Boy

25x25 PVC Cable Trunking
Complete with cover
Packaging: 80m / 40 Pcs



255 04

Ambalaj: 8 Adet
T Dirsek
Packaging: 8 pcs
T Corner



255 05

Ambalaj: 20 Adet
Sonlandırma Kapağı
Packaging: 20 pcs
End Cover



255 06

Ambalaj: 20 Adet
Kanal Birleştirme Parçası
Packaging: 20 pcs
Junction Piece

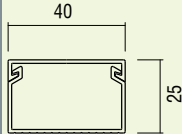

401 25

40x25

PVC Kablo Kanalı
Kapaklı Satılır

Ambalaj: 50m / 25 Boy

40x25 PVC Cable Trunking
Complete with cover
Packaging: 50m / 25 Pcs



405 01

Ambalaj: 10 Adet
İç Köşe
Packaging: 10 pcs
Internal Corner



405 02

Ambalaj: 6 Adet
Dış Köşe
Packaging: 6 pcs
External Corner



405 03

Ambalaj: 6 Adet
Dirsek 90°
Packaging: 6 pcs
90 Corner Piece

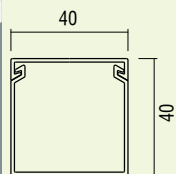

401 40

40x40

PVC Kablo Kanalı
Kapaklı Satılır

Ambalaj: 48m / 24 Boy

40x40 PVC Cable Trunking
Complete with cover
Packaging: 48m / 24 Pcs



405 04

Ambalaj: 8 Adet
T Dirsek
Packaging: 8 pcs
T Corner



405 05

Ambalaj: 20 Adet
Sonlandırma Kapağı
Packaging: 20 pcs
End Cover

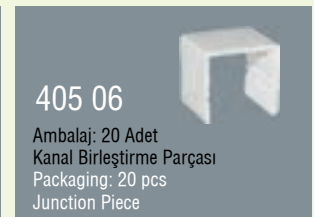

405 06

Ambalaj: 20 Adet
Kanal Birleştirme Parçası
Packaging: 20 pcs
Junction Piece

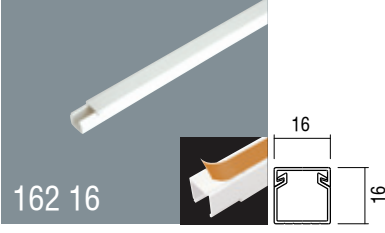
CANAFIX SERİ KENDİNDEN YAPIŞKANLI KABLO KANALLARI ve AKSESUARLARI
CANAFIX LINE SELF ADHESIVE CABLE TRUNKING & ACCESSORIES**162 16****16x16**PVC Kablo Kanalı
Kapaklı Satılır

Ambalaj: 192m / 96 Boy

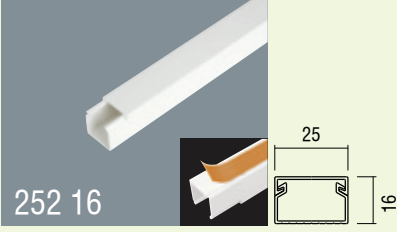
16x16 PVC Cable Trunking
Complete with cover
Packaging: 192m / 96 Pcs**252 16****25x16**PVC Kablo Kanalı
Kapaklı Satılır

Ambalaj: 128m / 64 Boy

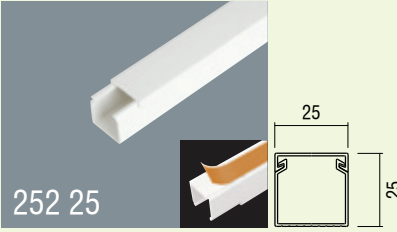
25x16 PVC Cable Trunking
Complete with cover
Packaging: 128m / 64 Pcs**252 25****25x25**PVC Kablo Kanalı
Kapaklı Satılır

Ambalaj: 80m / 40 Boy

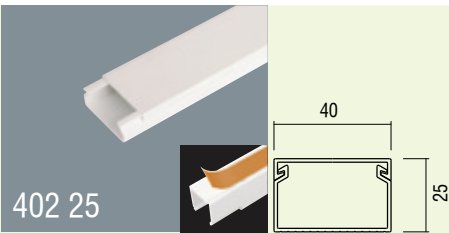
25x25 PVC Cable Trunking
Complete with cover
Packaging: 80m / 40 Pcs**402 25****40x25**PVC Kablo Kanalı
Kapaklı Satılır

Ambalaj: 50m / 25 Boy

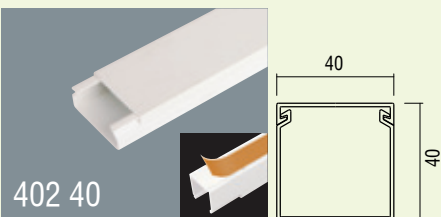
40x25 PVC Cable Trunking
Complete with cover
Packaging: 50m / 25 Pcs**402 40****40x40**PVC Kablo Kanalı
Kapaklı Satılır

Ambalaj: 48m / 24 Boy

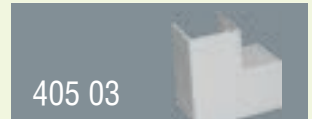
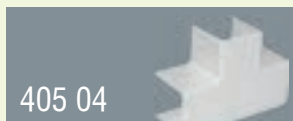
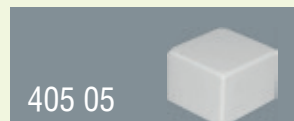
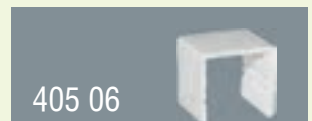
40x40 PVC Cable Trunking
Complete with cover
Packaging: 48m / 24 Pcs**255 01**Ambalaj: 10 Adet
İç Köşe
Packaging: 10 pcs
Internal Corner**255 02**Ambalaj: 6 Adet
Dış Köşe
Packaging: 6 pcs
External Corner**255 03**Ambalaj: 6 Adet
Dirsek 90°
Packaging: 6 pcs
90 Corner Piece**255 04**Ambalaj: 8 Adet
T Dirsek
Packaging: 8pcs
T Corner**255 05**Ambalaj: 20 Adet
Sonlandırma Kapağı
Packaging: 20 pcs
End Cover**255 06**Ambalaj: 20 Adet
Kanal Birleştirme Parçası
Packaging: 20 pcs
Junction Piece**405 01**Ambalaj: 10 Adet
İç Köşe
Packaging: 10 pcs
Internal Corner**405 02**Ambalaj: 6 Adet
Dış Köşe
Packaging: 6 pcs
External Corner**405 03**Ambalaj: 6 Adet
Dirsek 90°
Packaging: 6 pcs
90 Corner Piece**405 04**Ambalaj: 8 Adet
T Dirsek
Packaging: 8pcs
T Corner**405 05**Ambalaj: 20 Adet
Sonlandırma Kapağı
Packaging: 20 pcs
End Cover**405 06**Ambalaj: 20 Adet
Kanal Birleştirme Parçası
Packaging: 20 pcs
Junction Piece

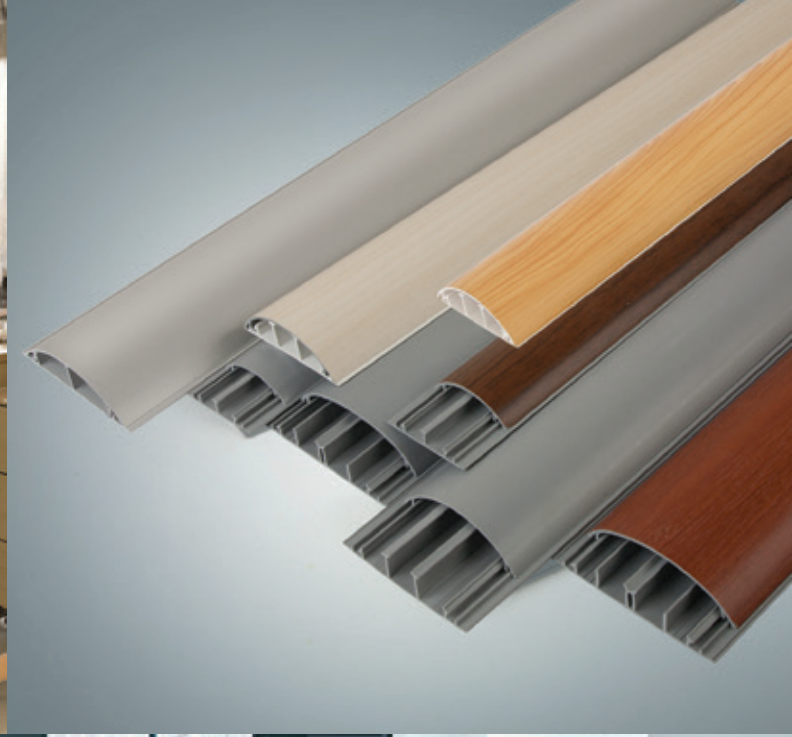

DÖŞEME ÜSTÜ KABLO KANAL SİSTEMLERİ
OVERFLOOR CABLE TRUNKING SYSTEMS

DÖŞEMEÜSTÜ KABLO KANALLARI
OVERFLOOR CABLE TRUNKS SYSTEMS



520 12

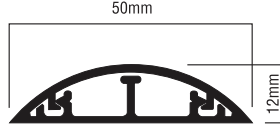

50x12

PVC Kanal / PVC Trunk
Uzunluk 2m / Length 2m
Ambalaj: 72m / Packaging: 72m
Kesit 50x12mm / Size 50x12mm
Kapaklı Satılır / Complete with cover
Kendinden Ara Bölmeli / Produced with self-separator Part
Renk RAL 7023 Gri / Grey Color RAL 7023



750 20

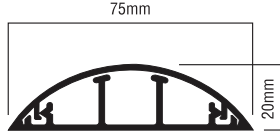

75x20

PVC Kanal / PVC Trunk
Uzunluk 2m / Length 2m
Ambalaj: 32m / Packaging: 32m
Kesit 75x20mm / Size 75x20mm
Kapaklı Satılır / With cover
Kendinden Ara Bölmeli / Produced with self-separator Part
Renk RAL 7023 Gri / Grey Color RAL 7023



750 01

L Dirsek/L Corner
Ambalaj: 20 adet
Packaging: 20Pieces



750 02

T Dirsek/T Corner
Ambalaj: 20 adet
Packaging: 20Pieces



750 03

Sonlandırma End Cover
Ambalaj: 20 adet
Packaging: 20Pieces



750 04

Kanal Birleştirme Parçası Junction Piece
Ambalaj: 20 adet
Packaging: 20Pieces



900 20

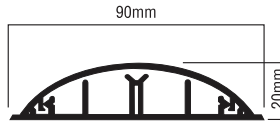

90x20

PVC Kanal / PVC Cable Trunking
Uzunluk 2m / Length 2m
Ambalaj: 24m / Packaging: 24m
Kesit 90x20mm / Size 90x20mm
Kapaklı Satılır / With cover
Kendinden Ara Bölmeli / Produced with self-separator Part
Renk RAL 7023 Gri / Grey Color RAL 7023



900 01

L Dirsek/L Corner
Ambalaj: 20 adet
Packaging: 20Pieces



900 02

T Dirsek/T Corner
Ambalaj: 20 adet
Packaging: 20Pieces



900 03

Sonlandırma End Cover
Ambalaj: 20 adet
Packaging: 20Pieces



900 04

Kanal Birleştirme Parçası Junction Piece
Ambalaj: 20 adet
Packaging: 20Pieces

Huş
Birch

Meşe
Oak

Ceviz
Walnut

Kanalları istediğiniz renk seçeneklerinde boyanabilir.
Can be painted with the color you choose

KENDİNDEN YAPIŞKANLI
DÖŞEMEÜSTÜ KABLO
KANALLARI

SELF ADHESIVE
OVERFLOOR CABLE
TRUNKS SYSTEMS



521 12



751 20



901 20

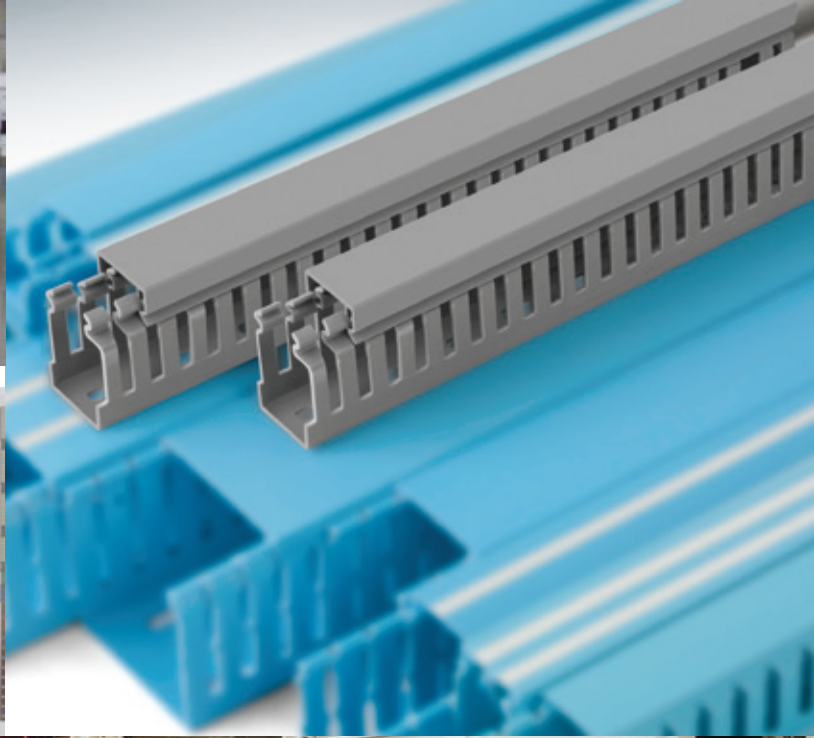
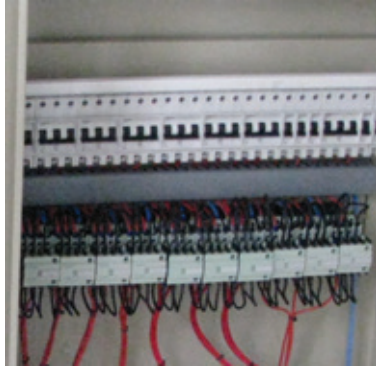

D LX LINE DELİKLİ PANO KANALLARI
DLX LINE SLOTTED CABLE TRUNKINGS

Tabanındaki delikler sayesinde hızlı ve kolay montaj sağlar.

Holes in the base allows quick and easy installation

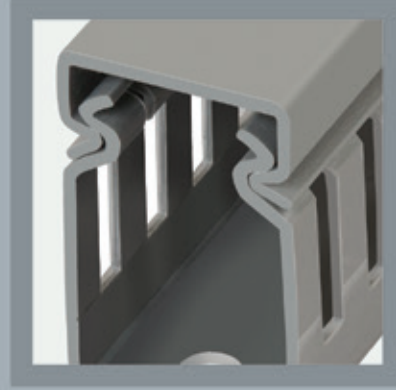
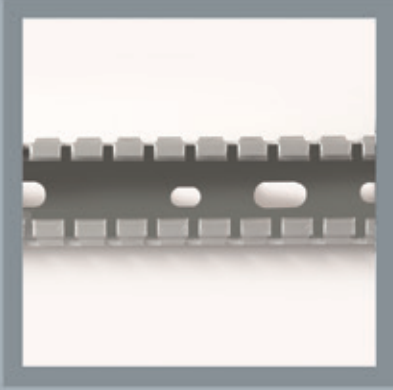

Kolay açılıp kapanma ile birlikte ekstra dayanıklılık sağlayan kapak ve gövde birleşimi.

The combination of the body and cover parts provide extra durability with its unique easy opening and design features.

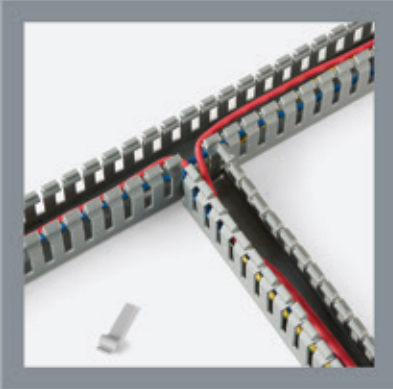

Tırnakları kırarak dilediğiniz yerden T bağlantılar yapabilirsiniz.

T connections can be made by breaking side nails.

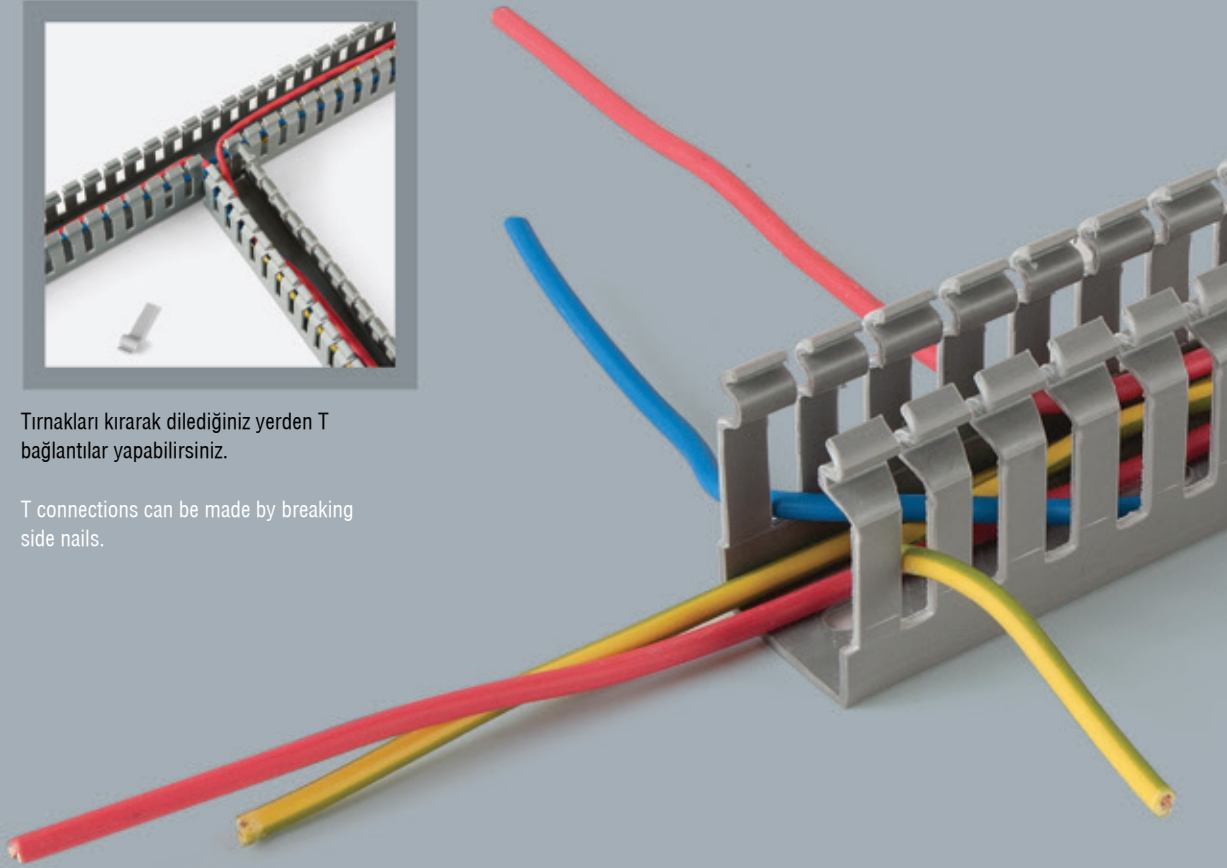

T EKNIK ÖZELLİKLER
TECHNICAL DETAILS

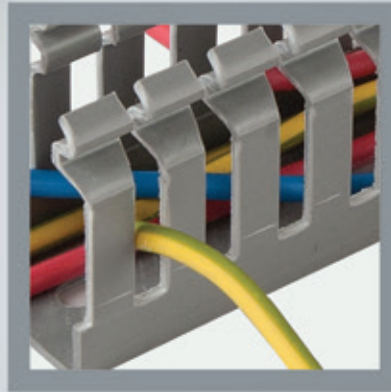
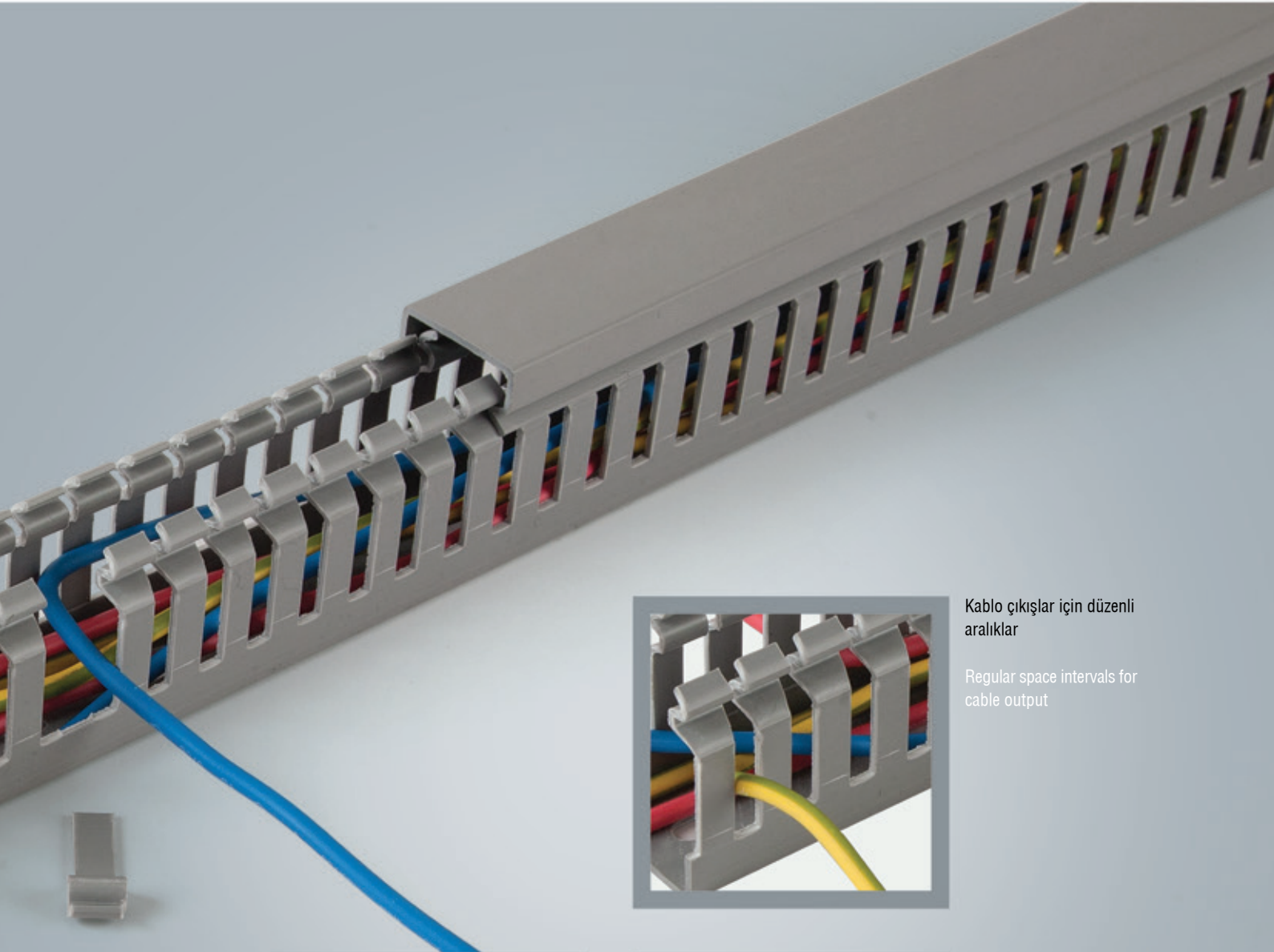

Kablo çıkışlar için düzenli aralıklar

Regular space intervals for cable output



Kesici aletlerle kolayca dilediğiniz ebatta kesebilirsiniz.

With Special Cutting tools, you can easily cut the trunking as your desired size.

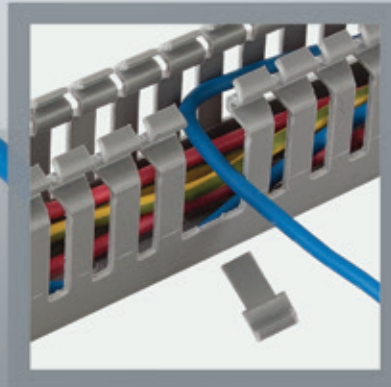

Önceden belirlenmiş kırılma hatları sayesinde dilediğiniz kadar kanal birleştirme ve kablo çıkışı yapabilirsiniz.

With its predesigned breaking lines, it is comfortable to make a vast unit of cable joint and cable outputs.

DLX LINE DELİKLİ PANO KANAL KAPAĞI
DLX LINE SLOTTED CABLE TRUNKINGS COVER



**Ambalaj
Package**

257 26	25'lik Kapak/Cover	80m
407 41	40'lık Kapak/Cover	60m
607 61	60'lık Kapak/Cover	40m
807 81	80'lık Kapak/Cover	30m



**Ambalaj
Package**

259 26	25'lik Kapak/Cover	80m
409 41	40'lık Kapak/Cover	60m
609 61	60'lık Kapak/Cover	40m
809 81	80'lık Kapak/Cover	30m

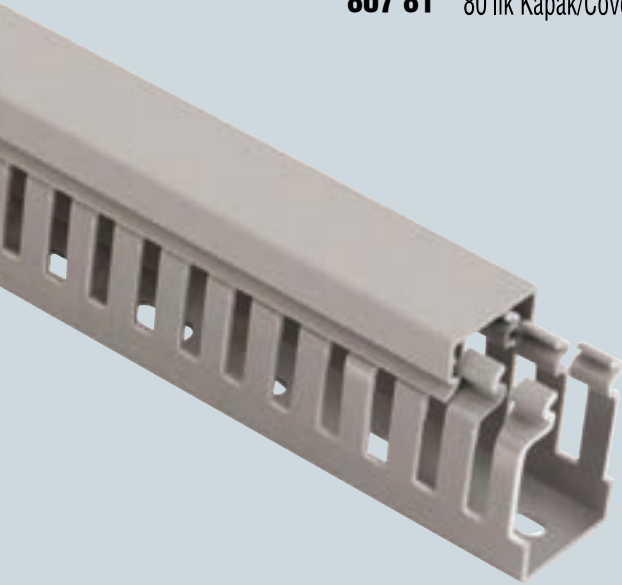

Özellikler

- Sert PVC UL94V0 M1 Alev Yayımayan
- Çalışma Ortam Sıcaklığı: -20° C +60° C
- Ral 7030 Gri

Features

- Rigit PVC UL94V0 M1 Self-extinguishing
- Temperature-Resistant: -20° C +60° C
- Ral 7030 Gri

Yüksekliği 30/40mm olan kanalların
delik ölçüleri
Overall Height 30/40mm

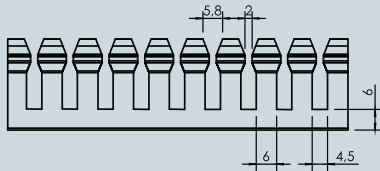

Yüksekliği 60mm olan kanalların
delik ölçüleri
Overall Height 60mm

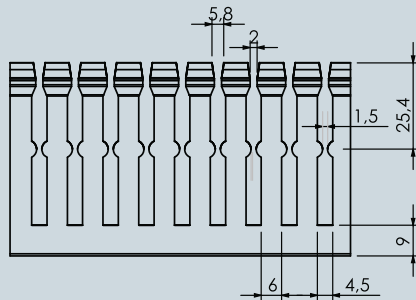

Yüksekliği 80mm olan kanalların
delik ölçüleri
Overall Height 80mm

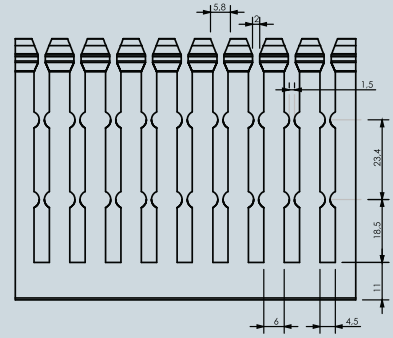

Taban genişliği 80mm olan kanalların delik ölçüleri

With 80mm

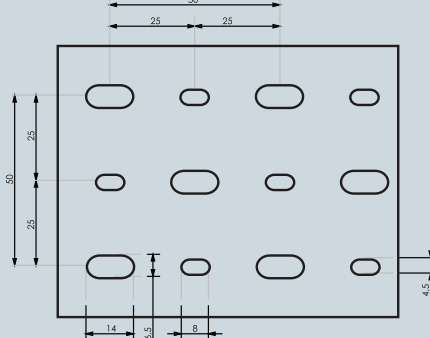

Taban genişliği 25/40/60cm olan kanalların
delik ölçüleri

With 25/40/60mm

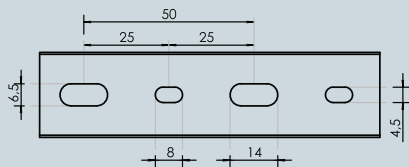

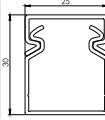
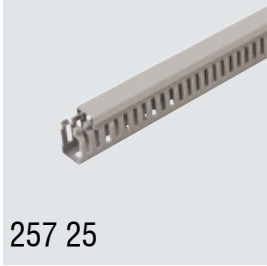
DLX LINE DELİKLİ PANO KANALLARI
DLX LINE SLOTTED CABLE TRUNKINGS**257 25****25x25**

PVC Kablo Kanalı
Kapaklı Satılır
Ambalaj: 100m
Renk: Gri RAL7030
25x25 Slotted Cable Trunking
Complete with cover
Packaging: 100m
Color: Grey RAL 7030

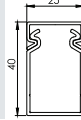
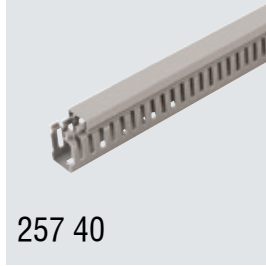
**257 40****25x40**

PVC Kablo Kanalı
Kapaklı Satılır
Ambalaj: 80m
Renk: Gri RAL7030
25x40 Slotted Cable Trunking
Complete with cover
Packaging: 80m
Color: Grey RAL 7030

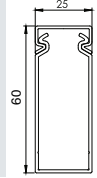
**257 60****25x60**

PVC Kablo Kanalı
Kapaklı Satılır
Ambalaj: 72m
Renk: Gri RAL7030
25x60 Slotted Cable Trunking
Complete with cover
Packaging: 72m
Color: Grey RAL 7030

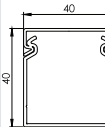
**407 40****40x40**

PVC Kablo Kanalı
Kapaklı Satılır
Ambalaj: 50m
Renk: Gri RAL7030
40x40 Slotted Cable Trunking
Complete with cover
Packaging: 50m
Color: Grey RAL 7030

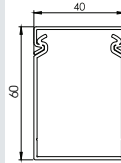
**407 60****40x60**

PVC Kablo Kanalı
Kapaklı Satılır
Ambalaj: 40m
Renk: Gri RAL7030
40x60 Slotted Cable Trunking
Complete with cover
Packaging: 40m
Color: Grey RAL 7030

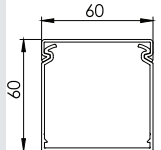
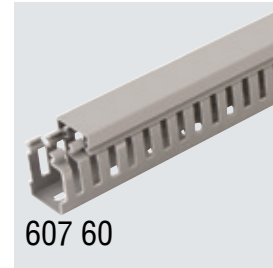
**607 60****60x60**

PVC Kablo Kanalı
Kapaklı Satılır
Ambalaj: 32m
Renk: Gri RAL7030
60x60 Slotted Cable Trunking
Complete with cover
Packaging: 32m
Color: Grey RAL 7030

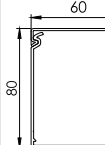
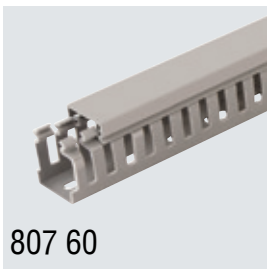
**807 60****80x60**

PVC Kablo Kanalı
Kapaklı Satılır
Ambalaj: 24m
Renk: Gri RAL7030
80x60 Slotted Cable Trunking
Complete with cover
Packaging: 24m
Color: Grey RAL 7030

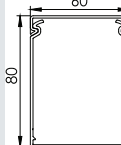
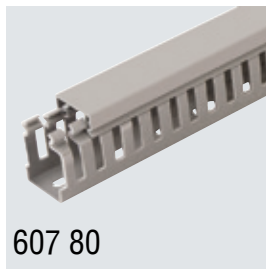
**607 80****60x80**

PVC Kablo Kanalı
Kapaklı Satılır
Ambalaj: 24m
Renk: Gri RAL7030
80x60 Slotted Cable Trunking
Complete with cover
Packaging: 24m
Color: Grey RAL 7030

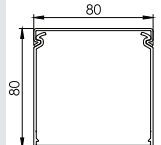
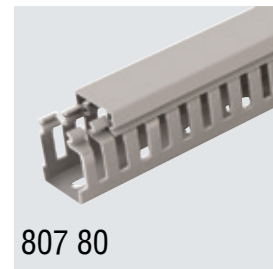
**807 80****80x80**

PVC Kablo Kanalı
Kapaklı Satılır
Ambalaj: 24m
Renk: Gri RAL7030
80x60 Slotted Cable Trunking
Complete with cover
Packaging: 24m
Color: Grey RAL 7030

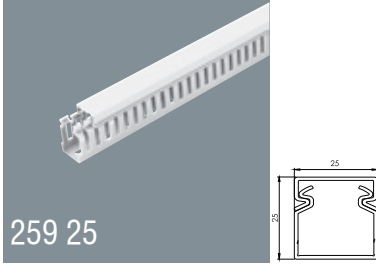
DLX LINE DELİKLİ PANO KANALLARI
DLX LINE SLOTTED CABLE TRUNKINGS**259 25****25x25**

PVC Kablo Kanalı
Kapaklı Satılır
Ambalaj: 100m
Renk: Beyaz RAL9016
25x25 Slotted Cable Trunking
Complete with cover
Packaging: 100m
Color: White RAL 9016

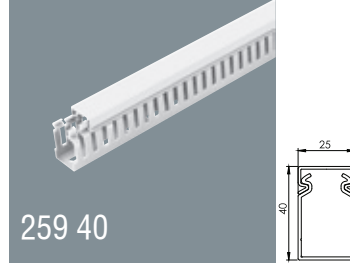
**259 40****25x40**

PVC Kablo Kanalı
Kapaklı Satılır
Ambalaj: 80m
Renk: Beyaz RAL9016
25x40 Slotted Cable Trunking
Complete with cover
Packaging: 80m
Color: White RAL 9016

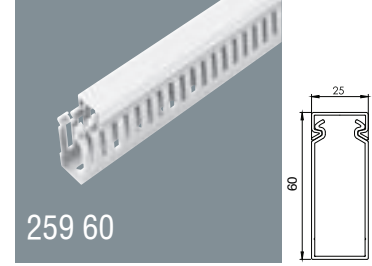
**259 60****25x60**

PVC Kablo Kanalı
Kapaklı Satılır
Ambalaj: 72m
Renk: Beyaz RAL9016
25x60 Slotted Cable Trunking
Complete with cover
Packaging: 72m
Color: White RAL 9016

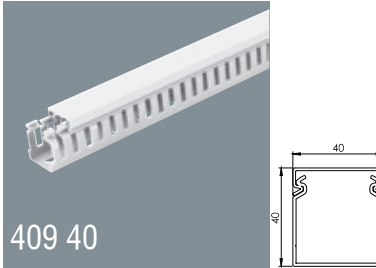
**409 40****40x40**

PVC Kablo Kanalı
Kapaklı Satılır
Ambalaj: 50m
Renk: Beyaz RAL9016
40x40 Slotted Cable Trunking
Complete with cover
Packaging: 50m
Color: White RAL 9016

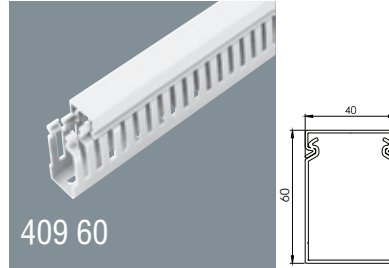
**409 60****40x60**

PVC Kablo Kanalı
Kapaklı Satılır
Ambalaj: 40m
Renk: Beyaz RAL9016
40x60 Slotted Cable Trunking
Complete with cover
Packaging: 40m
Color: White RAL 9016

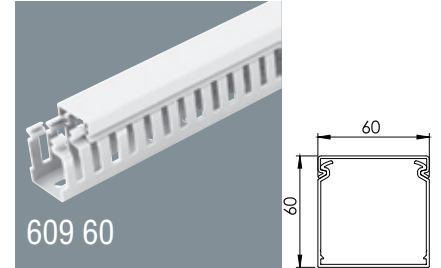
**609 60****60x60**

PVC Kablo Kanalı
Kapaklı Satılır
Ambalaj: 32m
Renk: Beyaz RAL9016
60x60 Slotted Cable Trunking
Complete with cover
Packaging: 32m
Color: White RAL 9016

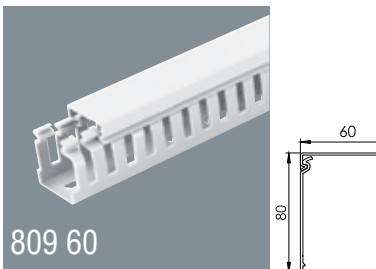
**809 60****80x60**

PVC Kablo Kanalı
Kapaklı Satılır
Ambalaj: 24m
Renk: Beyaz RAL9016
80x60 Slotted Cable Trunking
Complete with cover
Packaging: 24m
Color: White RAL 9016

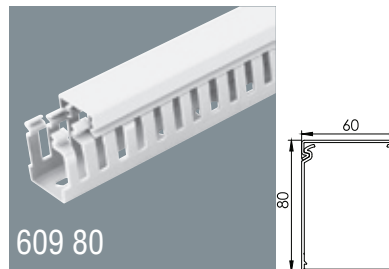
**609 80****60x80**

PVC Kablo Kanalı
Kapaklı Satılır
Ambalaj: 24m
Renk: Beyaz RAL9016
80x60 Slotted Cable Trunking
Complete with cover
Packaging: 24m
Color: White RAL 9016

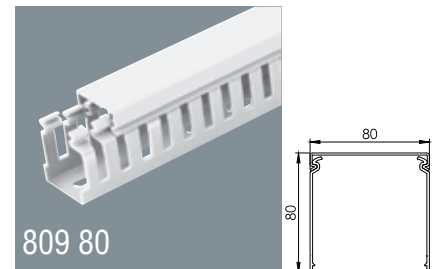
**809 80****80x80**

PVC Kablo Kanalı
Kapaklı Satılır
Ambalaj: 24m
Renk: Beyaz RAL9016
80x60 Slotted Cable Trunking
Complete with cover
Packaging: 24m
Color: White RAL 9016

HELEZON PANO SİRİLİ / HELICOID PANEL SPIRAL

Helezon Pano Spirali 50cm / Helezon Pano Spirali 50cm

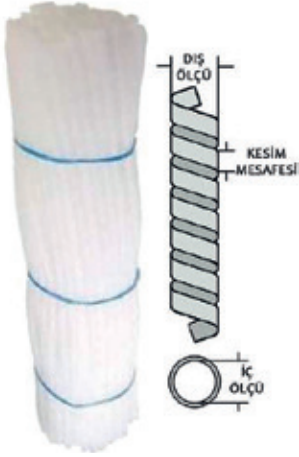

Kod Code	NO	Açıklama Description	İç Çap Inner Diameter	Dış Çap Out Diameter	Ambalaj Quantity
84006	1	6'lık Helezon Pano Spirali	5 mm	6 mm	100 Adet/Pcs
84008	2	8'lik Helezon Pano Spirali	7 mm	8 mm	100 Adet/Pcs
84011	3	11'lik Helezon Pano Spirali	9,5 mm	11 mm	100 Adet/Pcs
84014	4	14'lük Helezon Pano Spirali	12,5 mm	14 mm	50 Adet/Pcs
84017	5	17'lik Helezon Pano Spirali	15 mm	17 mm	50 Adet/Pcs



Helezon Pano Spirali 10m / Helezon Pano Spirali 10mt.

Kod Code	NO	Açıklama Description	İç Çap Inner Diameter	Dış Çap Out Diameter	Ambalaj Quantity
86006	1	6'lık Helezon Pano Spirali	5 mm	6 mm	1000 mt.
86008	2	8'lik Helezon Pano Spirali	7 mm	8 mm	800 mt.
86011	3	11'lik Helezon Pano Spirali	9,5 mm	11 mm	500 mt.
86014	4	14'lük Helezon Pano Spirali	12,5 mm	14 mm	400 mt.
86017	5	17'lik Helezon Pano Spirali	15 mm	17 mm	250 mt.

DLX[®] **FIL**
electric

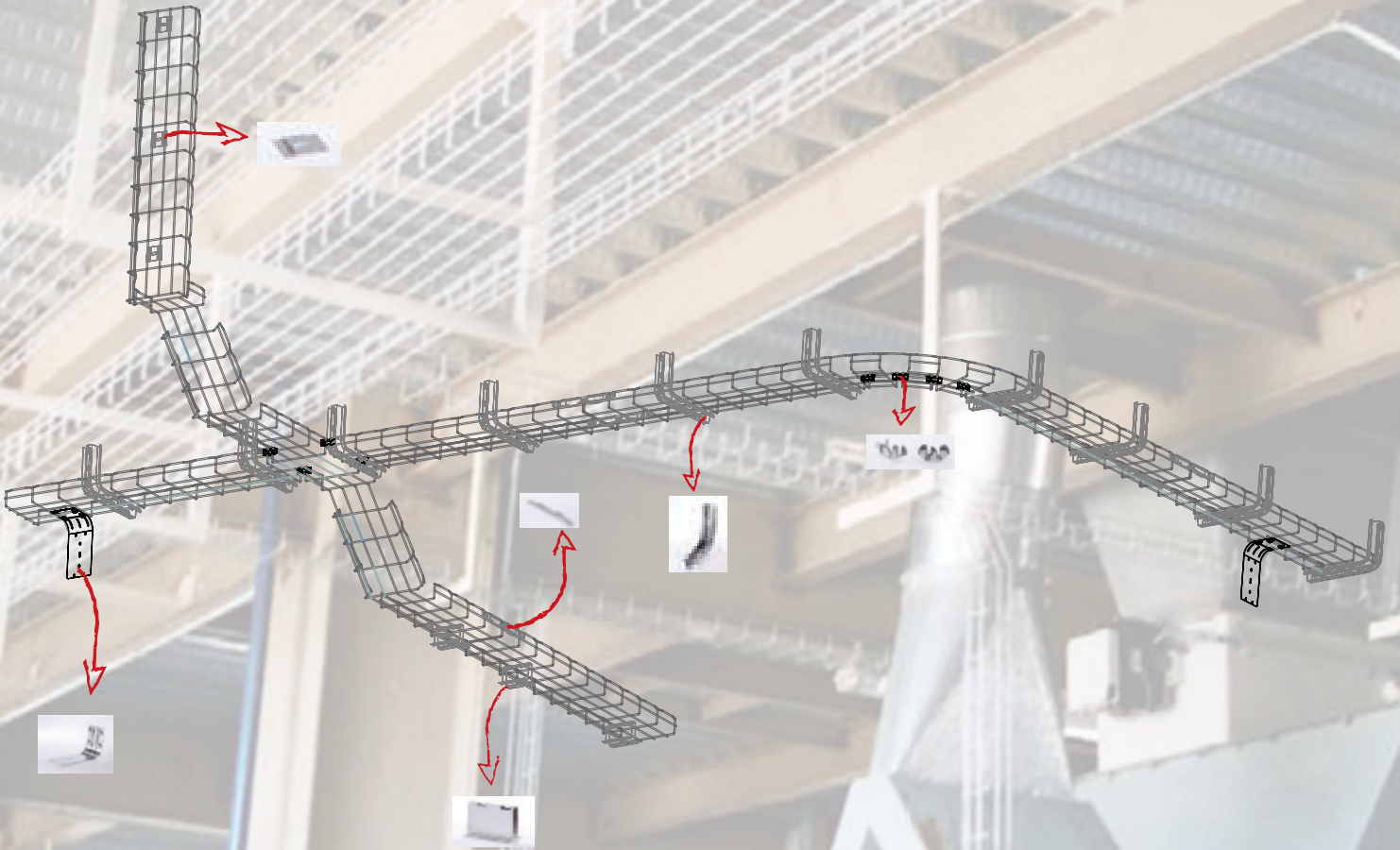

D DLXFIL TEL ÖRGÜ KABLO KANALLARI
DLXFIL WIRE-MESH CABLE TRAYS

DLXFİL DÜZ TEL ÖRGÜ KABLO KANALLARI / DLXFIL FLAT WIRE-MESH CABLE TRAYS

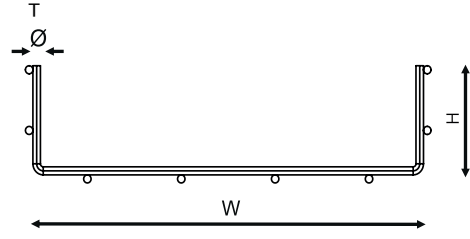

DÜZ TEL ÖRGÜ KABLO KANALLARI (H 35) FLAT WIRE-MESH TRAYS (H 35)

Ref	W mm	H mm	T Ø mm
1 4050 035	50	35	4
1 4100 035	100	35	4
1 4150 035	150	35	4
1 4200 035	200	35	4
1 4300 035	300	35	4
1 4400 035	400	35	4
1 4500 035	500	35	4
1 4600 035	600	35	4

DÜZ TEL ÖRGÜ KABLO KANALLARI (H 35) FLAT WIRE-MESH TRAYS (H 35)

Ref	W mm	H mm	T Ø mm
1 5050 035	50	35	5
1 5100 035	100	35	5
1 5150 035	150	35	5
1 5200 035	200	35	5
1 5300 035	300	35	5
1 5400 035	400	35	5
1 5500 035	500	35	5
1 5600 035	600	35	5

DÜZ TEL ÖRGÜ KABLO KANALLARI (H 50) FLAT WIRE-MESH TRAYS (H 50)

Ref	W mm	H mm	T Ø mm
1 4050 050	50	50	4
1 4100 050	100	50	4
1 4150 050	150	50	4
1 4200 050	200	50	4
1 4300 050	300	50	4
1 4400 050	400	50	4
1 4500 050	500	50	4
1 4600 050	600	50	4

DÜZ TEL ÖRGÜ KABLO KANALLARI (H 50) FLAT WIRE-MESH TRAYS (H 50)

Ref	W mm	H mm	T Ø mm
1 5050 050	50	50	5
1 5100 050	100	50	5
1 5150 050	150	50	5
1 5200 050	200	50	5
1 5300 050	300	50	5
1 5400 050	400	50	5
1 5500 050	500	50	5
1 5600 050	600	50	5

MALZEME TİPİ / MATERIAL TYPE

304 KALITE PASLANMAZ STAINLESS STEEL 304	316 KALITE PASLANMAZ STAINLESS STEEL 316	SICAK DALDIRMA GALVANİZ HOT-DIP GALVANIZED	ELEKTRO GALVANİZ ELECTRO GALVANIZED
SS304	SS316	HDG	EG

- Tel kablo kanalı standart uzunluk 3000 mm'dir
Wire-mesh cable trays standart length is 3000 mm
- Tel kablo kanalı bağlantısı için elemanı kullanılmalıdır
Each wire-mesh cable trays needs straight connectors
- Lütfen siparişlerinizde ürün kodu ve kaplama şeklini belirtiniz
Please indicate order code and the shape of coating in your orders

DLXFİL DÜZ TEL ÖRGÜ KABLO KANALLARI / DLXFIL FLAT WIRE-MESH CABLE TRAYS

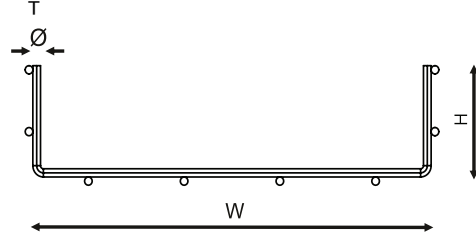

DÜZ TEL ÖRGÜ KABLO KANALLARI (H 75) FLAT WIRE-MESH TRAYS (H 75)

Ref	W mm	H mm	T Ø mm
1 4100 075	100	75	4
1 4150 075	150	75	4
1 4200 075	200	75	4
1 4300 075	300	75	4
1 4400 075	400	75	4
1 4500 075	500	75	4
1 4600 075	600	75	4

DÜZ TEL ÖRGÜ KABLO KANALLARI (H 75) FLAT WIRE-MESH TRAYS (H 75)

Ref	W mm	H mm	T Ø mm
1 5100 075	100	75	5
1 5150 075	150	75	5
1 5200 075	200	75	5
1 5300 075	300	75	5
1 5400 075	400	75	5
1 5500 075	500	75	5
1 5600 075	600	75	5

DÜZ TEL ÖRGÜ KABLO KANALLARI (H 100) FLAT WIRE-MESH TRAYS (H 100)

Ref	W mm	H mm	T Ø mm
1 4100 100	100	100	4
1 4150 100	150	100	4
1 4200 100	200	100	4
1 4300 100	300	100	4
1 4400 100	400	100	4
1 4500 100	500	100	4
1 4600 100	600	100	4

DÜZ TEL ÖRGÜ KABLO KANALLARI (H 100) FLAT WIRE-MESH TRAYS (H 100)

Ref	W mm	H mm	T Ø mm
1 5100 100	100	100	5
1 5150 100	150	100	5
1 5200 100	200	100	5
1 5300 100	300	100	5
1 5400 100	400	100	5
1 5500 100	500	100	5
1 5600 100	600	100	5

MALZEME TİPİ / MATERIAL TYPE

304 KALİTE PASLANMAZ STAINLESS STEEL 304	316 KALİTE PASLANMAZ STAINLESS STEEL 316	SICAK DALDIRMA GALVANİZ HOT-DIP GALVANIZED	ELEKTRO GALVANİZ ELECTRO GALVANIZED
SS304	SS316	HDG	EG

- Tel kablo kanalı standart uzunluk 3000 mm'dir
Wire-mesh cable trays standart length is 3000 mm
- Tel kablo kanalı bağlantısı için elemanı kullanılmalıdır
Each wire-mesh cable trays needs straight connectors
- Lütfen siparişlerinizde ürün kodu ve kaplama şeklini belirtiniz
Please indicate order code and the shape of coating in your orders

DLXFİL TEL ÖRGÜ KABLO KANAL AKSESUARLARI
DLXFIL WIRE-MESH CABLE TRAYS ACCESSORY LINE

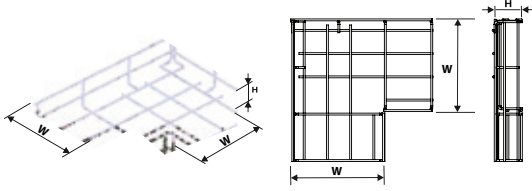

90° DÖNÜŞ ELAMANI (H: 50)
HORIZONTAL BENDS 90° (H: 50)

Ref	W (mm)	H (mm)	T Ø (mm)
1 4050 053	50	50	4
1 4100 053	100	50	4
1 4200 053	200	50	4
1 4300 053	300	50	4
1 4400 053	400	50	4
1 4500 053	500	50	4
1 4600 053	600	50	4

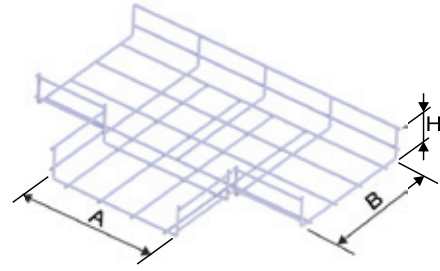

T DÖNÜŞ ELAMANI (H: 50)
HORIZONTAL TEES (H: 50)

Ref	W (mm)	H (mm)	T Ø (mm)
1 4050 054	50	50	4
1 4100 054	100	50	4
1 4200 054	200	50	4
1 4300 054	300	50	4
1 4400 054	400	50	4
1 4500 054	500	50	4
1 4600 054	600	50	4

90° DÖNÜŞ ELAMANI (H: 50)
HORIZONTAL BENDS 90° (H: 50)

Ref	W (mm)	H (mm)	T Ø (mm)
1 5050 053	50	50	5
1 5100 053	100	50	5
1 5200 053	200	50	5
1 5300 053	300	50	5
1 5400 053	400	50	5
1 5500 053	500	50	5
1 5600 053	600	50	5

T DÖNÜŞ ELAMANI (H: 50)
HORIZONTAL TEES (H: 50)

Ref	W (mm)	H (mm)	T Ø (mm)
1 5050 054	50	50	5
1 5100 054	100	50	5
1 5200 054	200	50	5
1 5300 054	300	50	5
1 5400 054	400	50	5
1 5500 054	500	50	5
1 5600 054	600	50	5

90° DÖNÜŞ ELAMANI (H: 100)
HORIZONTAL BENDS 90° (H: 100)

Ref	W (mm)	H (mm)	T Ø (mm)
1 5050 103	50	100	4
1 5100 103	100	100	4
1 5200 103	200	100	4
1 5300 103	300	100	4
1 5400 103	400	100	4
1 5500 103	500	100	4
1 5600 103	600	100	4

T DÖNÜŞ ELAMANI (H: 100)
HORIZONTAL TEES (H: 100)

Ref	W (mm)	H (mm)	T Ø (mm)
1 5050 104	50	100	4
1 5100 104	100	100	4
1 5200 104	200	100	4
1 5300 104	300	100	4
1 5400 104	400	100	4
1 5500 104	500	100	4
1 5600 104	600	100	4

90° DÖNÜŞ ELAMANI (H: 100)
HORIZONTAL BENDS 90° (H: 100)

Ref	W (mm)	H (mm)	T Ø (mm)
1 5050 100	50	100	5
1 5100 100	100	100	5
1 5200 100	200	100	5
1 5300 100	300	100	5
1 5400 100	400	100	5
1 5500 100	500	100	5
1 5600 100	600	100	5

T DÖNÜŞ ELAMANI (H: 100)
HORIZONTAL TEES (H: 100)

Ref	W (mm)	H (mm)	T Ø (mm)
1 5050 103	50	100	5
1 5100 103	100	100	5
1 5200 103	200	100	5
1 5300 103	300	100	5
1 5400 103	400	100	5
1 5500 103	500	100	5
1 5600 103	600	100	5

DLXFİL TEL ÖRGÜ KABLO KANAL AKSESUARLARI
DLXFIL WIRE-MESH CABLE TRAYS ACCESSORY LINE

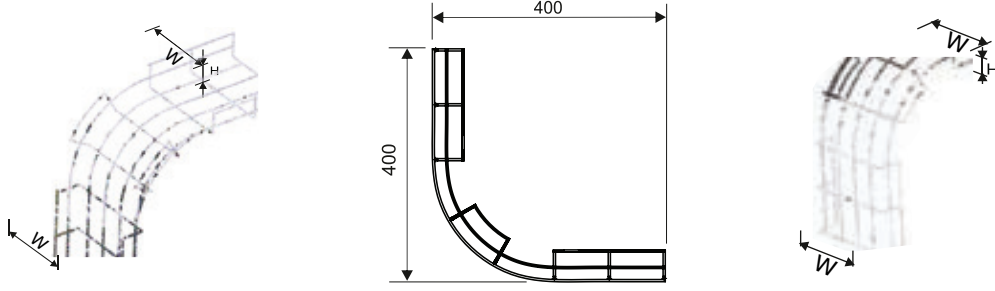

DIŞ BÜKEY DÖNÜŞ ELAMANI (H: 50)
OUTSIDE BENDS (H: 50)

Ref	W (mm)	H (mm)	T Ø (mm)
1 4050 052	50	50	4
1 4100 052	100	50	4
1 4200 052	200	50	4
1 4300 052	300	50	4
1 4400 052	400	50	4
1 4500 052	500	50	4
1 4600 052	600	50	4

İÇ BÜKEY DÖNÜŞ ELAMANI (H: 50)
INSIDE BENDS (H: 50)

Ref	W (mm)	H (mm)	T Ø (mm)
1 4050 051	50	50	4
1 4100 051	100	50	4
1 4200 051	200	50	4
1 4300 051	300	50	4
1 4400 051	400	50	4
1 4500 051	500	50	4
1 4600 051	600	50	4

DIŞ BÜKEY DÖNÜŞ ELAMANI (H: 50)
OUTSIDE BENDS (H: 50)

Ref	W (mm)	H (mm)	T Ø (mm)
1 5050 052	50	50	5
1 5100 052	100	50	5
1 5200 052	200	50	5
1 5300 052	300	50	5
1 5400 052	400	50	5
1 5500 052	500	50	5
1 5600 052	600	50	5

İÇ BÜKEY DÖNÜŞ ELAMANI (H: 50)
INSIDE BENDS (H: 50)

Ref	W (mm)	H (mm)	T Ø (mm)
1 5050 051	50	50	5
1 5100 051	100	50	5
1 5200 051	200	50	5
1 5300 051	300	50	5
1 5400 051	400	50	5
1 5500 051	500	50	5
1 5600 051	600	50	5

DIŞ BÜKEY DÖNÜŞ ELAMANI (H: 100)
OUTSIDE BENDS (H: 100)

Ref	W (mm)	H (mm)	T Ø (mm)
1 4050 102	50	100	4
1 4100 102	100	100	4
1 4200 102	200	100	4
1 4300 102	300	100	4
1 4400 102	400	100	4
1 4500 102	500	100	4
1 4600 102	600	100	4

İÇ BÜKEY DÖNÜŞ ELAMANI (H: 100)
INSIDE BENDS (H: 100)

Ref	W (mm)	H (mm)	T Ø (mm)
1 4050 101	50	100	4
1 4100 101	100	100	4
1 4200 101	200	100	4
1 4300 101	300	100	4
1 4400 101	400	100	4
1 4500 101	500	100	4
1 4600 101	600	100	4

DIŞ BÜKEY DÖNÜŞ ELAMANI (H: 100)
OUTSIDE BENDS (H: 100)

Ref	W (mm)	H (mm)	T Ø (mm)
1 5050 102	50	100	5
1 5100 102	100	100	5
1 5200 102	200	100	5
1 5300 102	300	100	5
1 5400 102	400	100	5
1 5500 102	500	100	5
1 5600 102	600	100	5

İÇ BÜKEY DÖNÜŞ ELAMANI (H: 100)
INSIDE BENDS (H: 100)

Ref	W (mm)	H (mm)	T Ø (mm)
1 5050 101	50	100	5
1 5100 101	100	100	5
1 5200 101	200	100	5
1 5300 101	300	100	5
1 5400 101	400	100	5
1 5500 101	500	100	5
1 5600 101	600	100	5

DLXFİL TEL ÖRGÜ KABLO KANAL AKSESUARLARI
DLXFIL WIRE-MESH CABLE TRAYS ACCESSORY LINE

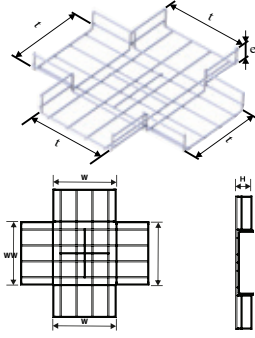

DÖRTLÜ DÖNÜŞ ELAMANI (H: 50)
HORIZONTAL CROSSING BENDS (H: 50)

Ref	W (mm)	H (mm)	T Ø (mm)
1 4050 055	50	50	4
1 4100 055	100	50	4
1 4200 055	200	50	4
1 4300 055	300	50	4
1 4400 055	400	50	4
1 4500 055	500	50	4
1 4600 055	600	50	4

DÖRTLÜ DÖNÜŞ ELAMANI (H: 50)
HORIZONTAL CROSSING BENDS (H: 50)

Ref	W (mm)	H (mm)	T Ø (mm)
1 5050 055	50	50	5
1 5100 055	100	50	5
1 5200 055	200	50	5
1 5300 055	300	50	5
1 5400 055	400	50	5
1 5500 055	500	50	5
1 5600 055	600	50	5

DÖRTLÜ DÖNÜŞ ELAMANI (H: 100)
HORIZONTAL CROSSING BENDS (H: 100)

Ref	W (mm)	H (mm)	T Ø (mm)
1 4050 105	50	100	4
1 4100 105	100	100	4
1 4200 105	200	100	4
1 4300 105	300	100	4
1 4400 105	400	100	4
1 4500 105	500	100	4
1 4600 105	600	100	4

DÖRTLÜ DÖNÜŞ ELAMANI (H: 100)
HORIZONTAL CROSSING BENDS (H: 100)

Ref	W (mm)	H (mm)	T Ø (mm)
1 5050 105	50	100	5
1 5100 105	100	100	5
1 5200 105	200	100	5
1 5300 105	300	100	5
1 5400 105	400	100	5
1 5500 105	500	100	5
1 5600 105	600	100	5

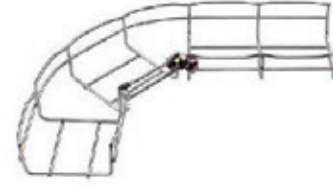

TEL KABLO KANILI 90°
YATAY DÖNÜŞ ELEMANI
WIRE-MESH CABLE TRAY
HORIZONTAL BENDS 90°
(H: 35 - 55 - 75 - 100)

Ref	W (mm)	H (mm)	T Ø (mm)
1 4050 356	50	35	4
1 4100 356	100	35	4
1 4200 356	200	35	4
1 4300 356	300	35	4
1 4400 356	400	35	4
1 4500 356	500	35	4
1 4600 356	600	35	4
1 5300 356	300	35	5
1 5400 356	400	35	5
1 5500 356	500	35	5
1 5600 356	600	35	5
2 4050 556	50	55	4
2 4100 556	100	55	4
2 4200 556	200	55	4
2 4300 556	300	55	4
2 4400 556	400	55	4
2 4500 556	500	55	4
2 4600 556	600	55	4
2 5300 556	300	55	5
2 5400 556	400	55	5
2 5500 556	500	55	5
2 5600 556	600	55	5
1 4100 756	100	75	4
1 4200 756	200	75	4
1 4300 756	300	75	4
1 4400 756	400	75	4
1 4500 756	500	75	4
1 4600 756	600	75	4
1 5300 756	300	75	5
1 5400 756	400	75	5
1 5500 756	500	75	5
1 5600 756	600	75	5
1 4100 106	100	100	4
1 4200 106	200	100	4
1 4300 106	300	100	4
1 4400 106	400	100	4
1 4500 106	500	100	4
1 4600 106	600	100	4
1 5300 106	300	100	5
1 5400 106	400	100	5
1 5500 106	500	100	5
1 5600 106	600	100	5

DLXFİL TEL ÖRGÜ KABLO KANAL AKSESUARLARI
DLXFIL WIRE-MESH CABLE TRAYS ACCESSORY LINE

TEL ÖRGÜ KABLO KANAL KAPAĞI / WIRE-MESH CABLE TRAYS COVER

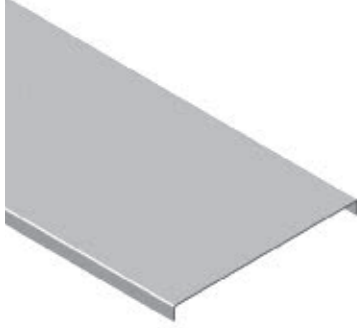

Ref	W (mm)	H (mm)	T Ø (mm)
1 1100 10	100	10	1,5
1 1200 10	200	10	1,5
1 1300 10	300	10	1,5
1 1400 10	400	10	1,5
1 1500 10	500	10	1,5
1 1600 10	600	10	1,5

TEL KABLO KANAL TAŞIYICISI / WIRE-MESH CABLE TRAY WALL SUPPORT

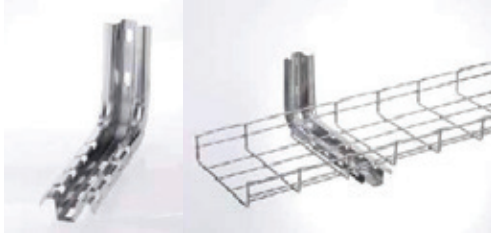

Ref.	W (mm)	304 KALİTE PASLANMAZ STAINLESS STEEL 304	SICAK DALDIRMA GALVANİZ <i>HOT-DIP GALVANIZED</i>	ELEKTRO GALVANİZ ELECTRO GALVANIZED
1 1050 20	50	SS304	HDG	EG
1 1100 20	100	SS304	HDG	EG
1 1200 20	200	SS304	HDG	EG
1 1300 20	300	SS304	HDG	EG
1 1400 20	400	SS304	HDG	EG
1 1500 20	500	SS304	HDG	EG
1 1600 20	600	SS304	HDG	EG

TEL ÖRGÜ KABLO KANAL DÖNÜŞ KİLİDİ / WIRE-MESH BENDING LOCKING PIECE

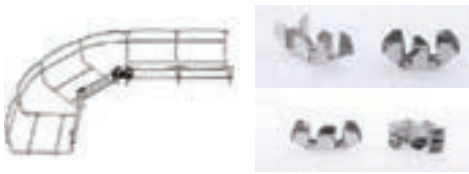

Ref.	304 KALİTE PASLANMAZ STAINLESS STEEL 304	SICAK DALDIRMA GALVANİZ <i>HOT-DIP GALVANIZED</i>	ELEKTRO GALVANİZ ELECTRO GALVANIZED
1 1050 30	SS304	HDG	EG
1 1100 30	SS304	HDG	EG

TEL ÖRGÜ KABLO KANAL YER BAĞLANTISI
WIRE-MESH WIRE-MESH CABLE TRAYS FLOOR SUPPORT

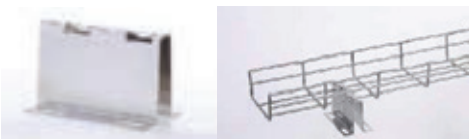

Ref.	304 KALİTE PASLANMAZ STAINLESS STEEL 304	SICAK DALDIRMA GALVANİZ <i>HOT-DIP GALVANIZED</i>	ELEKTRO GALVANİZ ELECTRO GALVANIZED
1 1050 40	HDG	EG	EG

DLXFİL TEL ÖRGÜ KABLO KANAL AKSESUARLARI
DLXFIL WIRE-MESH CABLE TRAYS ACCESSORY LINE

TEL ÖRGÜ KABLO KANAL KİLİDİ / WIRE-MESH CABLE TRAYS LOCKING PIECE



Ref.	304 KALİTE PASLANMAZ STAINLESS STEEL 304	SICAK DALDIRMA GALVANİZ HOT-DIP GALVANIZED	ELEKTRO GALVANİZ ELECTRO GALVANIZED
1 1050 50	SS304	HDG	EG

TEL ÖRGÜ KABLO KANAL EK ELAMAN / WIRE-MESH CABLE TRAYS JUNCTION PIECE



Ref.	304 KALİTE PASLANMAZ STAINLESS STEEL 304	SICAK DALDIRMA GALVANİZ HOT-DIP GALVANIZED	ELEKTRO GALVANİZ ELECTRO GALVANIZED
1 1050 60	SS304	HDG	EG

TEL ÖRGÜ KABLO KANAL GEÇİŞ SACI
WIRE-MESH CABLE TRAYS OUTLET PROTECTION FOR CABLES



Ref.	304 KALİTE PASLANMAZ STAINLESS STEEL 304	SICAK DALDIRMA GALVANİZ HOT-DIP GALVANIZED	ELEKTRO GALVANİZ ELECTRO GALVANIZED
1 1050 70	SS304	HDG	EG

TEL ÖRGÜ KABLO KANAL TAŞIYICI BAĞLANTI ELEMANI
WIRE-MESH CABLE TRAYS CENTRAL HANGING PLATE



Ref.	304 KALİTE PASLANMAZ STAINLESS STEEL 304	SICAK DALDIRMA GALVANİZ HOT-DIP GALVANIZED	ELEKTRO GALVANİZ ELECTRO GALVANIZED
1 1050 80	SS304	HDG	EG

TEL ÖRGÜ KABLO KANAL KİLİDİ MONTAJ APARATI
WIRE-MESH CABLE TRAYS



Ref.	304 KALİTE PASLANMAZ STAINLESS STEEL 304	SICAK DALDIRMA GALVANİZ HOT-DIP GALVANIZED	ELEKTRO GALVANİZ ELECTRO GALVANIZED
1 1050 90	SS304	HDG	EG



ŞEBEKE, UPS, DATA & TELEFON PRİZLERİ
ENERGY, UPS, DATA & TELEPHONE SOCKETS

245 45 45x45
45x45 Topraklı Priz (2 Modül)
45x45 Grounded Socket (2 Module)
Ambalaj: 20 Adet / Packaging: 20 pcs
Renk RAL 9010-9016 Beyaz
White Ral 9010-9016 Color
Çocuk Korumalı / Built in Baby Protection
45° Açılı Priz Yuvası / 45° Socket Hole

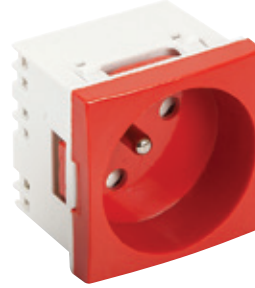

245 46 45x45
45x45 Topraklı Priz (2 Modül)
45x45 Grounded Socket (2 Module)
Ambalaj: 20 adet / Packaging: 20 pcs
Renk RAL 3020 Kırmızı
Ral 3020 Red Color
Çocuk Korumalı / Built in Baby Protection
45° Açılı Priz Yuvası / 45° Socket Hole

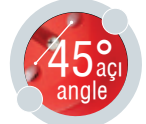

245 42 45x45
45x45 Topraklı Priz (2 Modül)
45x45 Grounded Socket (2 Module)
Ambalaj: 20 Adet / Packaging: 20 pcs
Renk RAL 9006 Yeşil
Green Ral 9006 Color
Çocuk Korumalı / Built in Baby Protection
45° Açılı Priz Yuvası / 45° Socket Hole

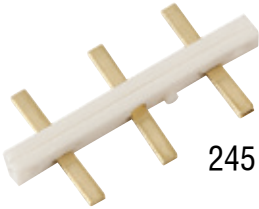
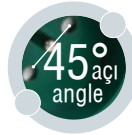

245 47 Priz Birleştirme Barası
Socket junction Bar
Ambalaj: 50 adet
Packaging: 50 pcs

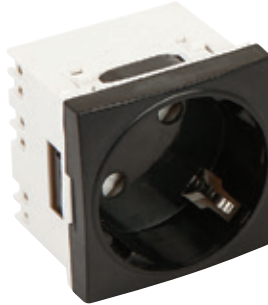

245 43 45x45
45x45 Topraklı Priz (2 Modül)
45x45 Grounded Socket (2 Module)
Ambalaj: 20 adet / Packaging: 20 pcs
Renk RAL 9005 Siyah
Ral 9005 Black Color
Çocuk Korumalı / Built in Baby Protection
45° Açılı Priz Yuvası / 45° Socket Hole

**TEKNİK ÖZELLİKLER / TECHNICAL SPECIFICATIONS**

45x45mm formatındadır.
Kolay kablo bağlantı baralarına sahiptir.
Kontakt girişleri 2.5 mm² kesitindeki kabloları uygundur.
(Tek damar ve çok telli kablo giriş yerine uygundur.)
Şebeke prizi renk RAL 9010 Beyaz'dır.
UPS Priz renk RAL 3020 kırmızıdır.
Köprü bağlantısına ihtiyaç yoktur.
Hızlı montaj imkanına sahiptir.
Çocuk korumalıdır.
45° açılı fiş yuvasına sahiptir.

45x45mm dimensions.
Practical and easy cable connection systems.
Contact entrance is available for cable cross section of 2.5 mm².
(Suitable for entrance of solid wire and stranded wire.)
Grounded Socket Ral 9010 White.
UPS Socket White Ral 3020 Red
No need for bridge connection
Quick installation.
Built in Baby Protection
45° angled plug slot.

DLX SİSTEM KABLO KANALLARI İÇİN 2-4-6-8 MODÜL ÇOKLU PRİZLER
2-4-6-8 MODULES OF SOCKETS/MULTIPLE SOCKETS FOR CABLE TRUNKING



245.46
TEKLİ UPS PRİZ
SINGLE UPS SOCKET



245.45
TEKLİ ŞEBEKE PRİZ
SINGLE GROUNDED SOCKET



245.86
2'Lİ UPS PRİZ
DOUBLE UPS SOCKET



245.85
2'Lİ ŞEBEKE PRİZ
DOUBLE GROUNDED SOCKET



245.88
3'LÜ UPS PRİZ
TRIPLE UPS SOCKET



245.87
3'LÜ ŞEBEKE PRİZ
TRIPLE GROUNDED SOCKET











245.90
4'LÜ UPS PRİZ
QUADRUPLE UPS SOCKET



245.89
4'LÜ ŞEBEKE PRİZ
QUADRUPLE GROUNDED SOCKET

DLX SİSTEM KABLO KANALLARI İÇİN 2-4-6-8 MODÜL ÇOKLU PRİZLER
2-4-6-8 MODULES OF SOCKETS/MULTIPLE SOCKETS FOR CABLE TRUNKING

AÇIKLAMA Description	Ref	RENK Colour	MODÜL Module	AMBALAJ Packaging
 16 A 250 V AC 2P +T	245 45	BEYAZ WHITE	2	20
 16 A 250 V AC 2 X 2P+T	245 85	BEYAZ WHITE	4	10
 16 A 250 V AC 3 X 2P+T	245 87	BEYAZ WHITE	6	16
 16 A 250 V AC 4 X 2P+T	245 89	BEYAZ WHITE	8	12
 16 A 250 V AC 2P +T	245 46	KIRMIZI RED	2	20
 16 A 250 V AC 2 X 2P+T	245 86	KIRMIZI RED	4	10
 16 A 250 V AC 3 X 2P+T	245 88	KIRMIZI RED	6	16
 16 A 250 V AC 4 X 2P+T	245 90	KIRMIZI RED	8	12

ŞEBEKE VE UPS PRİZLERİ
ENERGY & UPS SOCKETS**245 45EC 45x45**

45x45 Topraklı Priz (2 Modül)
45x45 Grounded Socket (2 Module)
Ambalaj: 20 Adet / Packaging: 20 pcs
Renk RAL 9010-9016 Beyaz
White Ral 9010-9016 Color
Çocuk Korumalı / Built in Baby Protection

**245 46EC 45x45**

45x45 Topraklı Priz (2 Modül)
45x45 Grounded Socket (2 Module)
Ambalaj: 20 adet / Packaging: 20 pcs
Renk RAL 3020 Kırmızı
Ral 3020 Red Color
Çocuk Korumalı / Built in Baby Protection

ŞEBEKE, UPS, DATA & TELEFON PRİZLERİ
ENERGY, UPS, DATA & TELEPHONE SOCKETS

245 44

45x45 İngiliz Tipi Priz45x45 British Type Socket
Ambalaj: 1 adet
Packaging: 1 pcs

245 05

45x45 Ünersal Tip Priz45x45 Universal Type Socket
Ambalaj: 1 adet /
Packaging: 1 pcs

245 49

45x45Data Telefon Priz Kapağı Eko
(2 Modül)
Ambalaj: 1 adet / Packaging: 1 pcs
Keystone Jack For Data-Telephone
Eco (2 Module)
Toz Korunmalı / Dust Protected

245 50

45x22.5Data Telefon Priz Kapağı Eko
(1 Modül)
Ambalaj: 1 adet / Packaging: 1 pcs
Keystone Jack For Data-Telephone
Eco (1 Module)
Toz Korunmalı / Dust Protected

245 07

45x45Data Telefon Priz Kapağı Etiketli
(2 Modül / 2 Port)
Ambalaj: 1 adet / Packaging: 1 pcs
Keystone Jack For Data-Telephone
With label (2 Module)
Toz Korunmalı / Dust Protected

245 08

45x45Data Telefon Priz Kapağı Etiketli
(2 Modül / 2 Port)
Ambalaj: 1 adet / Packaging: 1 pcs
Keystone Jack For Data-Telephone
(2 Module)
Toz Korunmalı / Dust Protected

245 09

45x22.5Data Telefon Priz Kapağı Etiketli
(1 Modül)
Ambalaj: 1 adet / Packaging: 1 pcs
Keystone Jack For Data-Telephone
(1 Module)
Toz Korunmalı / Dust Protected

245 66

45x22.5 Anahtar45x22.5 Switch
Ambalaj: 1 adet / Packaging: 1 pcs

245 67

CAT 3 PlugCAT 3 Plug
Ambalaj: 100 adet
Packaging: 100 pcs

245 69

CAT6 PlugCAT 6 Plug
Ambalaj: 100 adet
Packaging: 100 pcs

245 52

CAT 3 Telefon KonnektörüCAT 3 Keystone Jack For Telephone
Ambalaj: 1 adet / Packaging: 1 pcs
RJ 11-12 (1 Modül) / RJ 11-12 (2 Module)

245 53

CAT 5 Data KonnektörüCAT 5 Keystone Jack For Data
Ambalaj: 1 adet / Packaging: 1 pcs
RJ 45 (1 Modül) / RJ 45 (2 Module)

245 54

CAT 6 Data KonnektörüCAT 6 Keystone Jack For Data
Ambalaj: 1 adet / Packaging: 1 pcs
RJ 45 (1 Modül) / RJ 45 (2 Module)

250 10

250 11

45x45 45x22,5Data Telefon Priz Kapağı
Etiketli - CamlıKeystone Jack For Data-Telephone
White Label and Transparent Window
Ambalaj: 1 adet / Packaging: 1 pcs

ŞEBEKE, UPS, DATA & TELEFON PRİZLERİ
ENERGY, UPS, DATA & TELEPHONE SOCKETS

245 51

45x22.5
Boşluk Kapama (1 Modül)
Blind cover (1 Module)
Ambalaj: 1 adet / Packaging: 1 pcs

245 48

45x45
Boşluk Kapama (2 Modül)
Blind cover (2 Module)
Ambalaj: 1 adet / Packaging: 1 pcs

245 56

45x45 F Tipi Tv Prizi
45x45 F-type TV socket
Ambalaj: 1 adet / Packaging: 1 pcs

245 57

45x45 WGA Priz Konnektörü
45x45 WGA Socket Connector
Ambalaj: 1 adet / Packaging: 1 pcs

245 62

45x22.5 USB
45x22.5 USB
Ambalaj: 1 adet / Packaging: 1 pcs

245 63

45x22.5 HDMI
45x22.5 HDMI
Ambalaj: 1 adet / Packaging: 1 pcs

245 30

USB Type C + A Şarj
USB Type C + A Charger
Ambalaj: 1 adet / Packaging: 1 pcs
20W

245 91

45x22.5 Ses & Video
45x22.5 Audio & Video
Ambalaj: 1 adet
Packaging: 1 pcs

245 01

2 Portlu Type-C Şarj
Type-C Charger 2 Port
Ambalaj: 1 adet / Packaging: 1 pcs
2100 ma

245 02

USB Type C + A Şarj
USB Type C + A Charger
Ambalaj: 1 adet / Packaging: 1 pcs
2100 ma

245 06

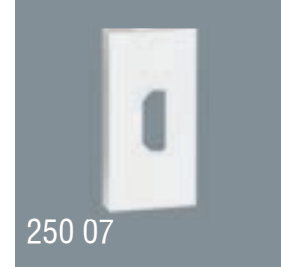
HDMI Dişi 90° Açılı Vidalı Adaptör
HDMI 90° Degr Whit Screw Adaptor
Ambalaj: 1 adet / Packaging: 1 pcs

250 07

45x22,5 HDMI Priz Kapağı
45x22,5 HDMI face Plate
Ambalaj: 1 adet / Packaging: 1 pcs

250 08

USB Dişi 90° Açılı Vidalı Adaptör
USB 90° Degr Whit Screw Adaptor
Ambalaj: 1 adet / Packaging: 1 pcs

250 09

45x22,5 USB Priz Kapağı
45x22,5 USB face Plate
Ambalaj: 1 adet / Packaging: 1 pcs

245 10

HDMI Kablosu Dişi, Dişi 30 cm.
HDMI Cable 30 cm.
Ambalaj: 1 adet / Packaging: 1 pcs

245 11

USB Kablosu Dişi, Dişi 30 cm.
USB Cable 30 cm.
Ambalaj: 1 adet / Packaging: 1 pcs

FİBER OPTİK AKSESUARLARI
FIBER OPTIC ACCESSORY



245 12

Fiber Ek Kaset Standart

Fiber Optic Cassettes
Ambalaj: 1 adet
Packaging: 1 pcs



245 13

Fiber Ek Kaset Mini

Fiber Optic Cassettes Mini
Ambalaj: 1 adet
Packaging: 1 pcs



245 14

Fiber Ek Kaset Camlı

Fiber Optic Cassettes
Transparent Cover
Ambalaj: 1 adet
Packaging: 1 pcs



250 01

**45x22,5 / LC-SC
Fiber Face Plate**

Ambalaj: 1 adet
Packaging: 1 pcs



250 02

**45x45 / 2 X LC
Doublex Face Plate**

Ambalaj: 1 adet
Packaging: 1 pcs



250 03

**45x45 / LC
Doublex Face Plate**

Ambalaj: 1 adet
Packaging: 1 pcs



250 04

**45x45 / 2 X SC
Doublex Face Plate**

Ambalaj: 1 adet
Packaging: 1 pcs



250 05

**45x45 / SC
Doublex Face Plate**

Ambalaj: 1 adet
Packaging: 1 pcs



250 06

**45x45 / 2 X ST
Doublex Face Plate**

Ambalaj: 1 adet
Packaging: 1 pcs



DÖŞEME ALTI ÇIKIŞ GÜÇ DAĞITIM KUTULARI
UNDERFLOOR POWER DISTRIBUTION BOXES

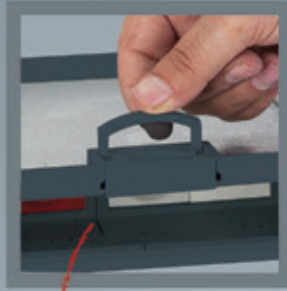

Açıp kapamayı kolaylaştıran tutma ünitesi
Holding unit makes easy opening & closing

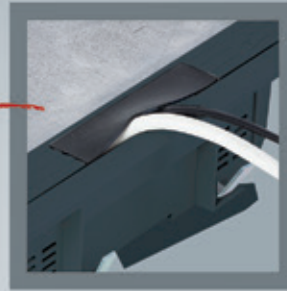

Üzerine ağırlık binmesi halinde kablolarda hasar oluşmasını önleyecek kauçuk kapatici.
Specially designed rubber part that protects any damage comes from weight factor



Gövde ve kapak bağlantısındaki dayanıklılığı artıran metal pim.

Extra durability with its distinctively made steel pin that helps the endurance between body and cover parts



Döşemeyle arasındaki seviye farkını ayarlama aparatları.

Adjustment apparatus to balance the level difference on the floor

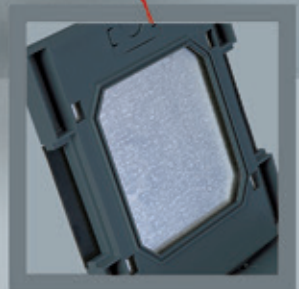

Kapakta çift taraflı monte etme imkanı
Two sided possibility to mount cover part

Tırnak geçmeli sistemi ile kolay montaj edilebilen priz çekirdeği yuvaları
Easy installation with plug-in system nail connection system

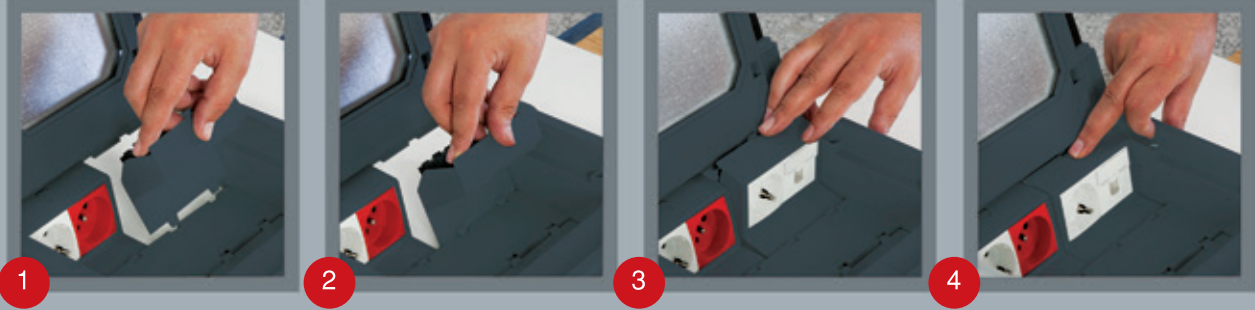

BOYUTLAR / DIMENSIONS

DIŞ KASA / OUTER BOX

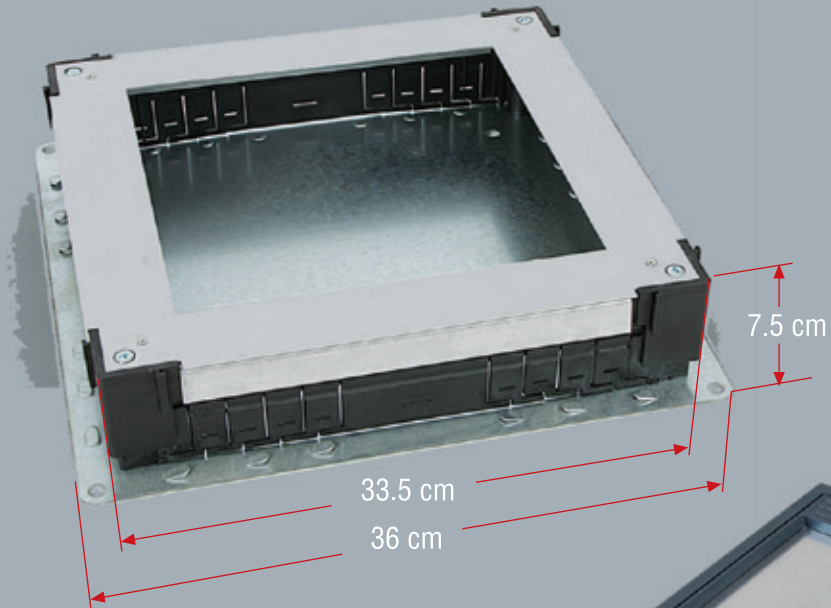

İÇ KASA / INNER BOX

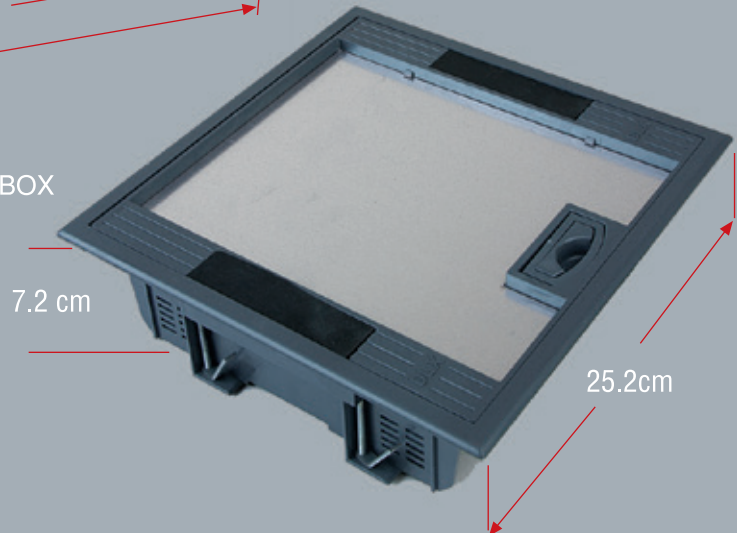

DÖŞEME ALTI ÇIKIŞ GÜÇ DAĞITIM KUTULARI
UNDERFLOOR POWER DISTRIBUTION BOXES



Ref: 890 08

Döşeme Altı Çıkış Kutusu
16 Modül 45x22.5mm

Underfloor Socket Output Box 16 Module

Ambalaj: 1 adet / Packaging: 1 pcs

4 Kaide / 4 Frame

Gövde ölçüsü: 23.5x23.5 cm

Body size: 23.5x23.5 cm

* Bofl Satılır / Sales without modules

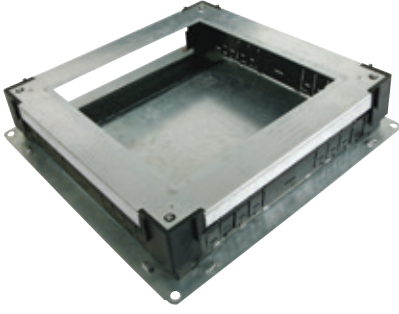

Ref: 890 09

Şap Altı Buat Kasası

Underfloor Box Metallic Base

Asansörlü / Lift system

Dış ölçü: 36x36 cm Outer size: 36x36 cm

Ambalaj: 1 adet / Packaging: 1 pcs

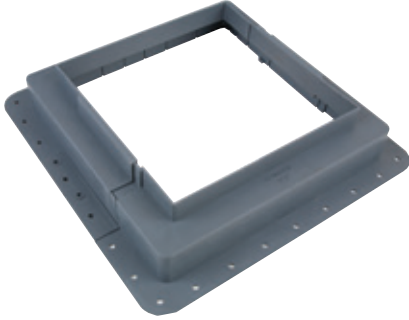

Ref: 890 11

Şap Altı Buat Kasası Plastik

Underfloor Box Plastic base

Ambalaj: 1 adet / Packaging: 1 pcs

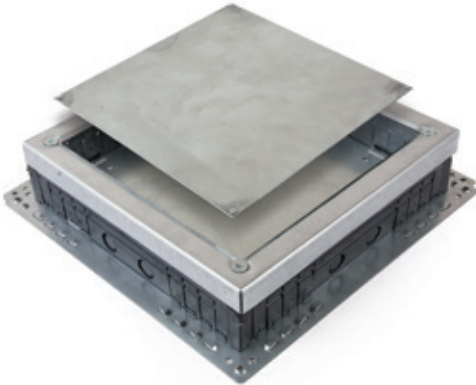
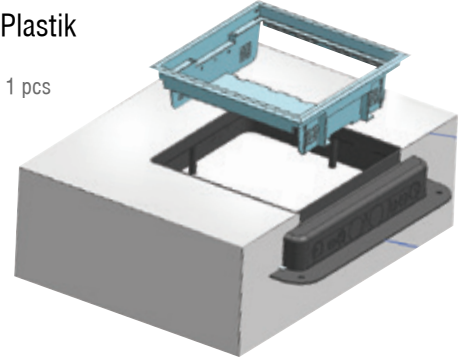

Ref: 890 13

Şap Altı Buat Kasası Kapağı

Underfloor Box Metallic Base Cover

Dış ölçü: 23.5x23.5 cm Outer size: 23.5x23.5 cm

Ambalaj: 1 adet / Packaging: 1 pcs

KABLO BAĞLARI / CABLE TIES



Ürün Kodu Product Code	Boyutlar / Dimensions		Renk Colour	Azami Sıkma Çapı (mm) Maximum coupling diameter (mm)	Açılma Mukavemeti Expansion Resistance	Poflet Miktarı Packaging Units
	Uzunluk x En (mm) Length x Width (mm)					
TSL - 100 M TSL - 140 M TSL - 200 M	100 150 200	2,5	Beyaz / Siyah Beyaz / Siyah Beyaz / Siyah	25 38 50	8 kg	100 ad./pcs
TSL - 150 I TSL - 200 I TSL - 250 I TSL - 300 I TSL - 370 I	150 200 250 300 370	3,6	Beyaz / Siyah Beyaz / Siyah Beyaz / Siyah Beyaz / Siyah Beyaz / Siyah	38 57 69 87 110	18 kg	
TSL - 200 ST TSL - 250 ST TSL - 300 ST TSL - 380 ST TSL - 400 ST	200 250 300 380 400	4,8	Beyaz / Siyah Beyaz / Siyah Beyaz / Siyah Beyaz / Siyah Beyaz / Siyah	56 72 87 109 129	22 kg	
TSL - 300 LHD TSL - 380 LHD TSL - 550 LHD	300 380 550	7,6	Beyaz / Siyah Beyaz / Siyah Beyaz / Siyah	82 108 162	54 kg	
TSL - 750 LHD	750	9,0	Beyaz / Siyah	233	79 kg	

YAPIŞKAN KROŞELER / ADHESIVE CROSHETS



Ürün Kodu Product Code	Boyutlar / Dimensions		Renk Colour	Kablo Bağı Girifli (mm) Cable Tie Entrance	Taflıma Mukavemeti Carriage Resistance	Poflet Miktarı Packaging Units
	Uzunluk x En (mm) Length x Width (mm)					
SDM - 101 SDM - 102	19 28	19 28	Beyaz / Siyah Beyaz / Siyah	4 4,5	8 kg 15 kg	100 ad.





DAHİLİ 45x45 MODÜL PRİZ KUTULARI / YAPISAL KABLOLAMA SİSTEMLERİ
45x45 SOCKET BOXES / STRUCTURAL CABLING SYSTEMS

DAHİLİ 45x45 MODÜL PRİZ KUTULARI
45x45 SOCKET BOXES**880 08****8'li Modül Priz Kutusu**
45x45mm

Socket Box for 8 Module 45x45mm

Ölçüsü: 210x110x70mm Size: 210x110x70mm

Ambalaj: 1 adet / Packaging: 1 pcs

**880 09****Dağıtım Buatı**

Distribution Box

Ölçüsü / Size: 210x110x70mm

Ambalaj: 1 adet / Packaging: 1 pcs

YAPISAL KABLOLAMA SİSTEMLERİ
STRUCTURAL CABLING SYSTEMS**PATCH PANEL**

245 70	1 Adet / Pcs	CAT5 e UTP Patch Panel 24 Port
245 71	1 Adet / Pcs	CAT5 e UTP Patch Panel 48 Port
245 72	1 Adet / Pcs	CAT6 e UTP Patch Panel 24 Port
245 73	1 Adet / Pcs	CAT6 e UTP Patch Panel 48 Port

PATCH CORD

245 80	1 Adet / Pcs	CAT5 e UTP 24 AWG Patch Cord 1m
245 81	1 Adet / Pcs	CAT5 e UTP 24 AWG Patch Cord 3m
245 82	1 Adet / Pcs	CAT5 e UTP 24 AWG Patch Cord 5m
245 83	1 Adet / Pcs	CAT6 e UTP 24 AWG Patch Cord 1m
245 84	1 Adet / Pcs	CAT6 e UTP 24 AWG Patch Cord 3m

KABLO OMURGASI**877 40**

877 39	1 Adet / Pcs	Kablo Omurgası Cable Spine
877 40B	1 Adet / Pcs	Kablo Omurgası Cable Spine
877 40G	1 Adet / Pcs	Kablo Omurgası Cable Spine
877 40W	1 Adet / Pcs	Kablo Omurgası Cable Spine
877 40N	1 Adet / Pcs	Kablo Omurgası Cable Spine

**1U ORGANİZER**

245 19	1 Adet / Pcs	Organizer Organizer
--------	-----------------	------------------------



Bu ürün grubu ile ilgili özel uygulama siparişleri alınır.
Custom made application orders are welcome in this product group.



O FİS BLOK SİSTEMLERİ
BLOCK OFFICE SYSTEMS

OFİS BLOK SİSTEMLERİ
BLOCK OFFICE SYSTEMS



980 01	1 Adet / Pcs	4 UPS + 3 ŞBK + 2 TLF + 2 DATA	(594x65x52 mm)
980 02	1 Adet / Pcs	4 UPS + 3 ŞBK + 2 TLF + 1 DATA	(572x65x52 mm)
980 03	1 Adet / Pcs	4 UPS + 3 ŞBK + 1 TLF + 1 DATA	(549x65x52 mm)



980 04	1 Adet / Pcs	4 UPS + 2 ŞBK + 2 TLF + 2 DATA	(549x65x52 mm)
980 05	1 Adet / Pcs	4 UPS + 2 ŞBK + 2 TLF + 1 DATA	(527x65x52 mm)
980 06	1 Adet / Pcs	4 UPS + 2 ŞBK + 1 TLF + 1 DATA	(504x65x52 mm)



980 07	1 Adet / Pcs	4 UPS + 1 ŞBK + 2 TLF + 2 DATA	(504x65x52 mm)
980 08	1 Adet / Pcs	4 UPS + 1 ŞBK + 2 TLF + 1 DATA	(482x65x52 mm)
980 09	1 Adet / Pcs	4 UPS + 1 ŞBK + 1 TLF + 1 DATA	(459x65x52 mm)



980 10	1 Adet / Pcs	3 UPS + 3 ŞBK + 2 TLF + 2 DATA	(549x65x52 mm)
980 11	1 Adet / Pcs	3 UPS + 3 ŞBK + 2 TLF + 1 DATA	(527x65x52 mm)
980 12	1 Adet / Pcs	3 UPS + 3 ŞBK + 1 TLF + 1 DATA	(504x65x52 mm)



980 13	1 Adet / Pcs	3 UPS + 2 ŞBK + 2 TLF + 2 DATA	(504x65x52 mm)
980 14	1 Adet / Pcs	3 UPS + 2 ŞBK + 2 TLF + 1 DATA	(482x65x52 mm)
980 15	1 Adet / Pcs	3 UPS + 2 ŞBK + 1 TLF + 1 DATA	(459x65x52 mm)

980 16	1 Adet / Pcs	3 UPS + 1 ŞBK + 2 TLF + 2 DATA	(459x65x52 mm)
980 17	1 Adet / Pcs	3 UPS + 1 ŞBK + 2 TLF + 1 DATA	(437x65x52 mm)
980 18	1 Adet / Pcs	3 UPS + 1 ŞBK + 1 TLF + 1 DATA	(414x65x52 mm)

980 19	1 Adet / Pcs	2 UPS + 2 ŞBK + 2 TLF + 2 DATA	(459x65x52 mm)
980 20	1 Adet / Pcs	2 UPS + 2 ŞBK + 2 TLF + 1 DATA	(437x65x52 mm)
980 21	1 Adet / Pcs	2 UPS + 2 ŞBK + 1 TLF + 1 DATA	(414x65x52 mm)

980 22	1 Adet / Pcs	2 UPS + 1 ŞBK + 2 TLF + 2 DATA	(414x65x52 mm)
980 23	1 Adet / Pcs	2 UPS + 1 ŞBK + 2 TLF + 1 DATA	(392x65x52 mm)
980 24	1 Adet / Pcs	2 UPS + 1 ŞBK + 1 TLF + 1 DATA	(369x65x52 mm)

980 25	1 Adet / Pcs	2 UPS + 1 ŞBK + 1 TLF	(347x65x52 mm)
980 26	1 Adet / Pcs	1 UPS + 1 ŞBK + 1 TLF + 1 DATA	(324x65x52 mm)
980 27	1 Adet / Pcs	1 UPS + 1 ŞBK + 1 TLF	(302x65x52 mm)

980 28	1 Adet / Pcs	4 UPS + 3 ŞBK	(504x65x52 mm)
980 29	1 Adet / Pcs	4 UPS + 2 ŞBK	(459x65x52 mm)
980 30	1 Adet / Pcs	4 UPS + 1 ŞBK	(414x65x52 mm)

980 31	1 Adet / Pcs	3 UPS + 3 ŞBK	(459x65x52 mm)
980 32	1 Adet / Pcs	3 UPS + 2 ŞBK	(414x65x52 mm)
980 33	1 Adet / Pcs	3 UPS + 1 ŞBK	(369x65x52 mm)

980 34	1 Adet / Pcs	2 UPS + 2 ŞBK	(369x65x52 mm)
980 35	1 Adet / Pcs	2 UPS + 1 ŞBK	(324x65x52 mm)
980 36	1 Adet / Pcs	1 UPS + 1 ŞBK	(279x65x52 mm)

* ŞBK= Grounded Socket (245 45), (245 45 EC)

OFİS BLOK SİSTEMLERİ
BLOCK OFFICE SYSTEMS

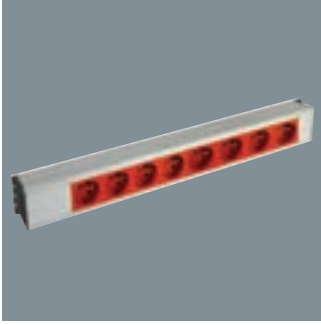

980 37	1 Adet / Pcs	10 UPS (639x65x52 mm)
980 38	1 Adet / Pcs	9 UPS (594x65x52 mm)
980 39	1 Adet / Pcs	8 UPS (549x65x52 mm)
980 40	1 Adet / Pcs	7 UPS (504x65x52 mm)
980 41	1 Adet / Pcs	6 UPS (459x65x52 mm)
980 42	1 Adet / Pcs	5 UPS (414x65x52 mm)
980 43	1 Adet / Pcs	4 UPS (369x65x52 mm)
980 44	1 Adet / Pcs	3 UPS (324x65x52 mm)
980 45	1 Adet / Pcs	2 UPS (279x65x52 mm)



980 46	1 Adet / Pcs	10 ŞBK (639x65x52 mm)
980 47	1 Adet / Pcs	9 ŞBK (594x65x52 mm)
980 48	1 Adet / Pcs	8 ŞBK (549x65x52 mm)
980 49	1 Adet / Pcs	7 ŞBK (504x65x52 mm)
980 50	1 Adet / Pcs	6 ŞBK (459x65x52 mm)
980 51	1 Adet / Pcs	5 ŞBK (414x65x52 mm)
980 52	1 Adet / Pcs	4 ŞBK (369x65x52 mm)
980 53	1 Adet / Pcs	3 ŞBK (324x65x52 mm)
980 54	1 Adet / Pcs	2 ŞBK (279x65x52 mm)



980 55	1 Adet / Pcs	4 Modül Bofl Blok 2 Yan Kapak (279x65x52 mm)
980 56	1 Adet / Pcs	4 Module Empty with 2 Side Covers (279x65x52 mm)
980 57	1 Adet / Pcs	6 Modül Bofl Blok 2 Yan Kapak (324x65x52 mm)
980 58	1 Adet / Pcs	6 Module Empty with 2 Side Covers (324x65x52 mm)
980 59	1 Adet / Pcs	8 Modül Bofl Blok 2 Yan Kapak (369x65x52 mm)
980 60	1 Adet / Pcs	8 Module Empty with 2 Side Covers (369x65x52 mm)
980 61	1 Adet / Pcs	10 Modül Bofl Blok 2 Yan Kapak (414x65x52 mm)
980 62	1 Adet / Pcs	10 Module Empty with 2 Side Covers (414x65x52 mm)
980 63	1 Adet / Pcs	12 Modül Bofl Blok 2 Yan Kapak (459x65x52 mm)
		12 Module Empty with 2 Side Covers (459x65x52 mm)
		14 Modül Bofl Blok 2 Yan Kapak (504x65x52 mm)
		14 Module Empty with 2 Side Covers (504x65x52 mm)
		16 Modül Bofl Blok 2 Yan Kapak (549x65x52 mm)
		16 Module Empty with 2 Side Covers (549x65x52 mm)
		18 Modül Bofl Blok 2 Yan Kapak (594x65x52 mm)
		18 Module Empty with 2 Side Covers (594x65x52 mm)
		20 Modül Bofl Blok 2 Yan Kapak (639x65x52 mm)
		20 Module Empty with 2 Side Covers (639x65x52 mm)

* ŞBK= Grounded Socket (245 45), (245 45 EC)



980 65

Kabin Tipi Sigortalı Priz Bloğu (6 ŞBK 1U)
Rack Cabinet Type 1U Power Socket Group
With Circuit Breaker (6 sockets with fuse)
Ambalaj: 1 adet / Packaging: 1 pcs



980 68

Kabin Tipi Anahtarlı Priz Bloğu (6 ŞBK 1U)
Rack Cabinet Type 1U Power Socket Group
With Switch (6 sockets with fuse)
Ambalaj: 1 adet / Packaging: 1 pcs



980 69

Kabin Tipi Şok Korumalı Priz Bloğu (6 ŞBK 1U)
Rack Cabinet Type 1U Power Socket Group
With Parafudr (6 sockets with fuse)
Ambalaj: 1 adet / Packaging: 1 pcs

OFİS BLOK SİSTEMLERİ ÇİFT KOMPARTMANLI
DOUBLE COMPARTMENT BLOCK OFFICE SYSTEMS

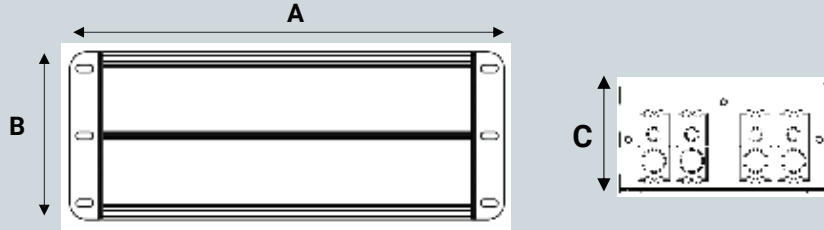

ÜRÜN KODU Product Code	MODÜL SAYISI Number of Moduls	ÜRÜN ÖLÇÜLERİ (mm) Product Dimensions (mm)		
		A	B	C
REF 1100 04	4+4	130	101,5	54
REF 1100 05	5+5	153	101,5	54
REF 1100 06	6+6	175	101,5	54
REF 1100 07	7+7	198	101,5	54
REF 1100 08	8+8	220	101,5	54
REF 1100 09	9+9	243	101,5	54
REF 1100 10	10+10	265	101,5	54
REF 1100 11	11+11	288	101,5	54
REF 1100 12	12+12	310	101,5	54
REF 1100 13	13+13	333	101,5	54
REF 1100 14	14+14	355	101,5	54



MASA ÜSTÜ PRİZ SİSTEMLERİ ve ALÜMİNYUM SÜTUNLAR
DESKTOP SOCKET SYSTEMS & ALUMINIUM COLUMNS

ÇALIŞMA ORTAMI ÇÖZÜMLERİ
WORK STATION SOLUTIONS

DİKEY PRİZ BLOKLARI
VERTICAL ALLUMINIUM FLOOR STANDING POWER SOCKET

980 64 Dikey Tekyüz Priz Bloğu
One Face Vertical Alluminium Floor
Ambalaj: 1 adet / Packaging: 1 pcs

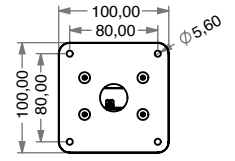
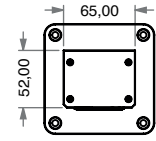
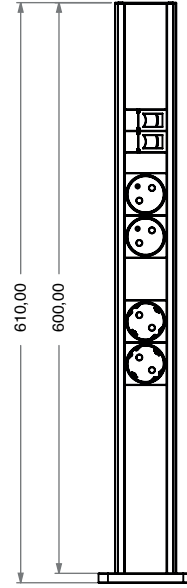

980 66 Dikey Çiftiyüz Priz Bloğu
Double Face Vertical Alluminium Floor
Ambalaj: 1 adet / Packaging: 1 pcs

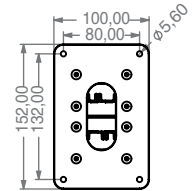
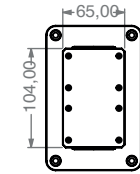
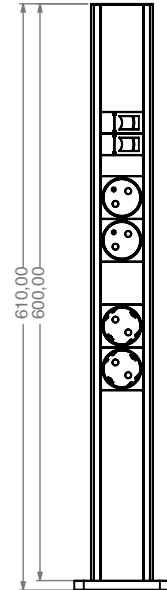

980 67 Dikey Dört yüz Priz Bloğu
Four Face Vertical Alluminium Floor
Ambalaj: 1 adet / Packaging: 1 pcs

Boş Satılır.
Priz kombinasyonları için fiyat sorunuz.
Sales (without sockets) as empty
Ask for pricing with different socket combinations.

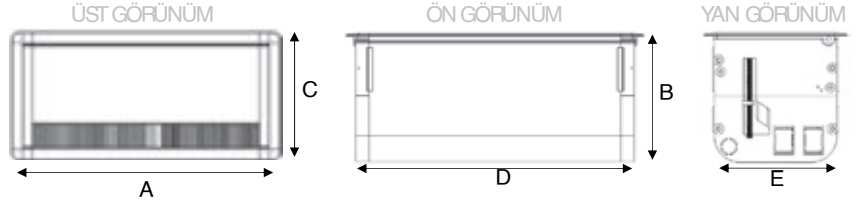

CODE	MODULE	RENK/COLOR	Yuva Ölçüsü Slot Size (mm)
9810501	5	Anodized	D:156 E:98
9810502		Siyah/Black	
9810503		Beyaz/White	
9810801	8	Anodized	D:225 E:98
9810802		Siyah/Black	
9810803		Beyaz/White	
9811201	12	Anodized	D:325 E:98
9811202		Siyah/Black	
9811203		Beyaz/White	
9811601	16	Anodized	D:405 E:98
9811602		Siyah/Black	
9811603		Beyaz/White	
9812001	20	Anodized	D:495 E:98
9812002		Siyah/Black	
9812003		Beyaz/White	

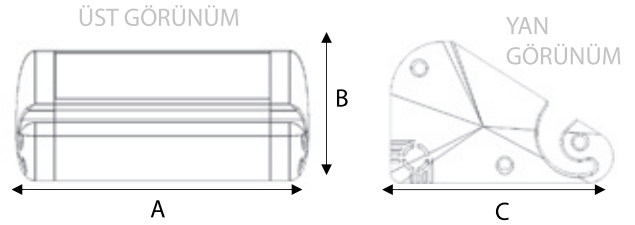

CODE	MODULE	RENK/COLOR	Ölçüsü/Size (mm)
9840501	5	Anodized	A:153 B:68 C:108
9840502		Siyah/Black	
9840503		Beyaz/White	
9840801	8	Anodized	A:221 B:68 C:108
9840802		Siyah/Black	
9840803		Beyaz/White	
9841201	12	Anodized	A:311 B:68 C:108
9841202		Siyah/Black	
9841203		Beyaz/White	
9841601	16	Anodized	A:401 B:68 C:108
9841602		Siyah/Black	
9841603		Beyaz/White	
9842001	20	Anodized	A:491 B:68 C:108
9842002		Siyah/Black	
9842003		Beyaz/White	

MASA OFİS BLOK SİSTEMLERİ / DEKSTOP SOCKET SYSTEMS



CODE	MODULE	RENK/COLOR	Yuva Ölçüsü Slot Size (mm)
9990601	6	Inox	Ø100
9990602		Siyah/Black	
9990603		Bronz/Broze	
9990604		Altın/Gold	
9990801	8	Inox	Ø100
9990802		Siyah/Black	
9990803		Bronz/Broze	
9990804		Altın/Gold	
9991001	10	Inox	Ø100
9991002		Siyah/Black	
9991003		Bronz/Broze	
9991004		Altın/Gold	



CODE	MODULE	RENK/COLOR	Adet/Unit
9850501	5	Anodized	5
9850502		Siyah/Black	
9850503		Beyaz/White	
9850801	8	Anodized	8
9850802		Siyah/Black	
9850803		Beyaz/White	
9851201	12	Anodized	12
9851202		Siyah/Black	
9851203		Beyaz/White	
9851601	16	Anodized	16
9851602		Siyah/Black	
9851603		Beyaz/White	
9852001	20	Anodized	20
9852002		Siyah/Black	
9852003		Beyaz/White	





985 06 01 Masa Ofis Blok
Desktop Socket Block
6 Modül / 6 Module
Beyaz / White
1 Adet / Pcs



985 06 02 Masa Ofis Blok
Desktop Socket Block
6 Modül / 6 Module
Siyah / Black
1 Adet / Pcs

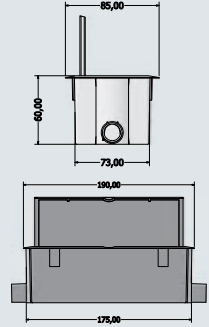

985 06 03 Masa Ofis Blok
Desktop Socket Block
6 Modül / 6 Module
Gri / Gray
1 Adet / Pcs

YUVARLAK 3 MODÜL MASA BLOĞU CIRCLE 3 MODULE DESKTOP SOCKET SYSTEMS



999 03 01 Yuvarlak Masa Ofis Blok
Circle Desktop Socket Block
3 Modül / 3 Module
Beyaz / White
1 Adet / Pcs

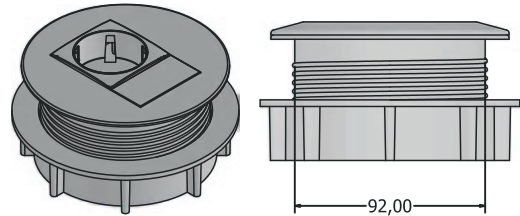

999 03 02 Masa Ofis Blok
Desktop Socket Block
3 Modül / 3 Module
Gri / Gray
1 Adet / Pcs

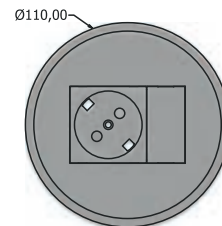

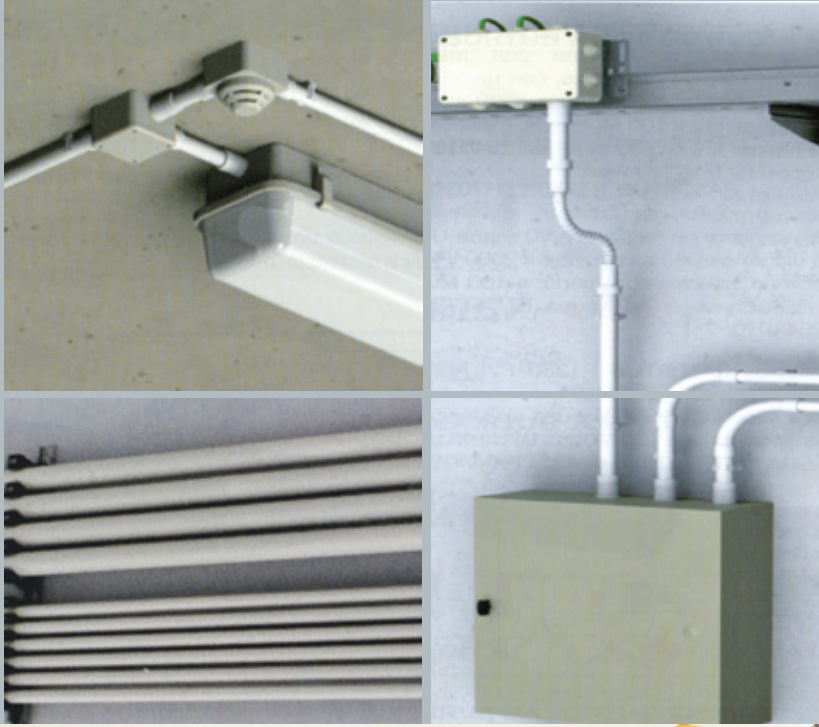

ELEKTRİK TESİSAT BORULARI
ELECTRICAL INSTALLATION CONDUITS



ELEKTRİK TESİSAT BORULARI
ELECTRICAL INSTALLATION CONDUITS**PVC Düz Boru / PVC Rigid Conduit**
Hafif Seri / Light Gauge**Alev Yayımayan - Yayla Bükülebilir TesiSat Borusu**

DLX 801 Kullanım Alanları: Mekanik zorlamaların fazla olmadığı yerlerde, sıva altı ve sıva üstünde, alçıpan, duvar yada asma tavan içinde ve yükseltilmiş döşeme uygulamalarında.

Self Extinguishing - Malleable Rigid Conduit

DLX 801 Field of Application: Used in applications on walls, under the plaster; in all kinds of concrete floor and ceiling slabs, on suspended ceilings and under areas where low mechanical shocks and loadings are expected and also available for raised floor.

Renk Kod No
Color Code

Siyah
Black
Ral 9005



Gri
Grey
Ral 7035



Beyaz
White
Ral 9016

PVC DÜZ BORU / PVC RIGID CONDUIT

Ürün Kodu Product Code	Dış Çap (mm) Ex. Diameter (mm)	İç Çap (mm) Int. Diameter (mm)	Ambalaj Packaging
DLX 801 16	Ø 16	13,6	102 m
DLX 801 20	Ø 20	17,4	102 m
DLX 801 25	Ø 25	22,1	51 m
DLX 801 32	Ø 32	28,6	45 m
DLX 801 40	Ø 40	36,7	30 m

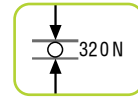
**Teknik Özellikler**

Standart	: EN 61386-21 / 22
Malzeme	: PVC Bazlı Termoplastik
Sıkıştırma Dayanımı	: 320 Newton / 60 sn./sec / 23± 2°C
Darbe Dayanımı	: 1 kg. / 100 mm / -25°C
Çalışma Ortamı Sıcaklığı	: - 25°C + 60°C
Yalıtım Gerilimi	: 2000 V. / 50 Hz. / 15 dak.
Kendiliğinden Sönen PVC Malzeme	: UL94 V0
Boru Boyu	: 3 m.

Technical Details

Standard	: EN 61386-21 / 22
Material	: PVC Based Thermoplastic
Compression Resistance	: 320 Newton / 60 sn./sec / 23± 2°C
Impact Resistance	: 1 kg. / 100 mm / -25°C
Working Temperature	: - 25°C + 60°C
Insulating Strength	: 2000 V. / 50 Hz. / 15 min.
PVC Material (Self Extinguishing)	: UL94 V0
Conduit Length	: 3 m.

ELEKTRİK TESİSAT BORULARI
ELECTRICAL INSTALLATION CONDUITS**PVC Düz Boru / PVC Rigid Conduit**
Orta Seri / Medium Gauge**Alev Yayımayan - Yayla Bükülebilir Tesiilat Borusu**

DLX 802 Kullanım Alanları: Mekanik zorlamaların fazla olmadığı yerlerde, sıva altı ve sıva üstünde, alçıpan, duvar yada asma tavan içinde ve yükseltimimli döşeme uygulamalarında.

Self Extinguishing - Malleable Rigid Conduit

DLX 802 Field of Application: Used in applications on walls, under the plaster; in all kinds of concrete floor and ceiling slabs, on suspended ceilings and under areas where low mechanical shocks and loadings are expected and also available for raised floor.

Renk Kod No
Color Code

Siyah
Black
Ral 9005



Gri
Grey
Ral 7035



Beyaz
White
Ral 9016

PVC DÜZ BORU / PVC RIGID CONDUIT

Ürün Kodu Product Code	Dış Çap (mm) Ex. Diameter (mm)	İç Çap (mm) Int. Diameter (mm)	Ambalaj Packaging
DLX 802 16	Ø 16	13,1	102 m
DLX 802 20	Ø 20	16,9	102 m
DLX 802 25	Ø 25	21,6	51 m
DLX 802 32	Ø 32	27,8	45 m
DLX 802 40	Ø 40	35,6	30 m

**Teknik Özellikler**

Standart	: EN 61386-21 / 22
Malzeme	: PVC Bazlı Termoplastik
Sıkıştırma Dayanımı	: 750 Newton / 60 sn./sec / 23± 2°C
Darbe Dayanımı	: 1 kg. / 100 mm / -25°C
Çalışma Ortamı Sıcaklığı	: - 25°C + 60°C
Yalıtım Gerilimi	: 2000 V. / 50 Hz. / 15 dak.
Kendiliğinden Sönen PVC Malzeme	: UL94 V0
Boru Boyu	: 3 m.

Technical Details

Standard	: EN 61386-21 / 22
Material	: PVC Based Thermoplastic
Compression Resistance	: 750 Newton / 60 sn./sec / 23± 2°C
Impact Resistance	: 1 kg. / 100 mm / -25°C
Working Temperature	: - 25°C + 60°C
Insulating Strength	: 2000 V. / 50 Hz. / 15 min.
PVC Material (Self Extinguishing)	: UL94 V0
Conduit Length	: 3 m.

ELEKTRİK TESİSAT BORULARI
ELECTRICAL INSTALLATION CONDUITS



Mufllu PVC Düz Boru / Sleeved PVC Rigid Conduit
Hafif Seri / Light Gauge

Alev Yayımayan - Yayla Bükülebilen Tesisat Borusu

DLX 804 Kullanım Alanları: Mekanik zorlamaların fazla olmadığı yerlerde, sıva altı ve sıva üstünde, alçıpan, duvar yada asma tavan içinde ve yükseltilmiş döşeme uygulamalarında.

Self Extinguishing - Malleable Rigid Conduit

DLX 804 Field of Application: Used in applications on walls, under the plaster; in all kinds of concrete floor and ceiling slabs, on suspended ceilings and under areas where low mechanical shocks and loadings are expected and also available for raised floor.

Renk Kod No
Color Code



Siyah
Black
Ral 9005



Gri
Grey
Ral 7035



Beyaz
White
Ral 9016

PVC DÜZ BORU / PVC RIGID CONDUIT

Ürün Kodu Product Code	Dış Çap (mm) Ex. Diameter (mm)	İç Çap (mm) Int. Diameter (mm)	Ambalaj Packaging
DLX 804 16	Ø 16	13,6	102 m
DLX 804 20	Ø 20	17,4	102 m
DLX 804 25	Ø 25	22,1	51 m
DLX 804 32	Ø 32	28,6	45 m
DLX 804 40	Ø 40	36,7	30 m



Teknik Özellikler

Standart	: EN 61386-21 / 22
Malzeme	: PVC Bazlı Termoplastik
Sıkıştırma Dayanımı	: 320 Newton / 60 sn./sec / 23± 2°C
Darbe Dayanımı	: 1 kg. / 100 mm / -25°C
Çalışma Ortamı Sıcaklığı	: - 25°C + 60°C
Yalıtım Gerilimi	: 2000 V. / 50 Hz. / 15 dak.
Kendiliğinden Sönen PVC Malzeme	: UL94 V0
Boru Boyu	: 3 m.

Technical Details

Standard	: EN 61386-21 / 22
Material	: PVC Based Thermoplastic
Compression Resistance	: 320 Newton / 60 sn./sec / 23± 2°C
Impact Resistance	: 1 kg. / 100 mm / -25°C
Working Temperature	: - 25°C + 60°C
Insulating Strength	: 2000 V. / 50 Hz. / 15 min.
PVC Material (Self Extinguishing)	: UL94 V0
Conduit Length	: 3 m.

ELEKTRİK TESİSAT BORULARI
ELECTRICAL INSTALLATION CONDUITS**Muflu PVC Düz Boru / Sleeved PVC Rigid Conduit**
Orta Seri / Medium Gauge**Alev Yayımayan - Yayla Bükülebilir Tesiilat Borusu**

DLX 805 Kullanım Alanları: Mekanik zorlamaların fazla olmadığı yerlerde, sıva altı ve sıva üstünde, alçıpan, duvar yada asma tavan içinde ve yükseltilmiş döşeme uygulamalarında.

Self Extinguishing - Malleable Rigid Conduit

DLX 805 Field of Application: Used in applications on walls, under the plaster; in all kinds of concrete floor and ceiling slabs, on suspended ceilings and under areas where low mechanical shocks and loadings are expected and also available for raised floor.

Renk Kod No
Color Code

Siyah
Black
Ral 9005



Gri
Grey
Ral 7035



Beyaz
White
Ral 9016

PVC DÜZ BORU / PVC RIGID CONDUIT

Ürün Kodu Product Code	Dış Çap (mm) Ex. Diameter (mm)	İç Çap (mm) Int. Diameter (mm)	Ambalaj Packaging
DLX 805 16	Ø 16	13,1	102 m
DLX 805 20	Ø 20	16,9	102 m
DLX 805 25	Ø 25	21,6	51 m
DLX 805 32	Ø 32	27,8	45 m
DLX 805 40	Ø 40	35,6	30 m

**Teknik Özellikler**

Standart	: EN 61386-21 / 22
Malzeme	: PVC Bazlı Termoplastik
Sıkıştırma Dayanımı	: 750 Newton / 60 sn./sec / 23± 2°C
Darbe Dayanımı	: 1 kg. / 100 mm / -25°C
Çalışma Ortamı Sıcaklığı	: - 25°C + 60°C
Yalıtım Gerilimi	: 2000 V. / 50 Hz. / 15 dak.
Kendiliğinden Sönen PVC Malzeme	: UL94 V0
Boru Boyu	: 3 m.

Technical Details

Standard	: EN 61386-21 / 22
Material	: PVC Based Thermoplastic
Compression Resistance	: 750 Newton / 60 sn./sec / 23± 2°C
Impact Resistance	: 1 kg. / 100 mm / -25°C
Working Temperature	: - 25°C + 60°C
Insulating Strength	: 2000 V. / 50 Hz. / 15 min.
PVC Material (Self Extinguishing)	: UL94 V0
Conduit Length	: 3 m.

DÜZ BORU BAĞLANTI AKSESUARLARI / CONDUIT INSTALLATIONS ACCESSORIES

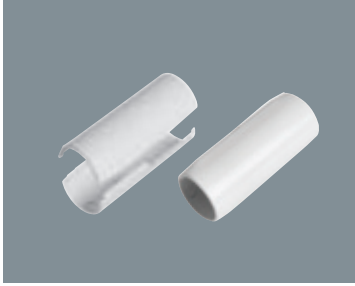

Ek Mufu / Coupling

Ürün Kodu Product Code	Çap Diameter	Ambalaj Packaging
DLX 811 16	Ø 16	100 Ad./Pcs.
DLX 811 20	Ø 20	100 Ad./Pcs.
DLX 811 25	Ø 25	100 Ad./Pcs.
DLX 811 32	Ø 32	100 Ad./Pcs.



Dirsek / Bending Piece

Ürün Kodu Product Code	Çap Diameter	Ambalaj Packaging
DLX 821 16	Ø 16	100 Ad./Pcs.
DLX 821 20	Ø 20	100 Ad./Pcs.
DLX 821 25	Ø 25	100 Ad./Pcs.
DLX 821 32	Ø 32	25 Ad./Pcs.

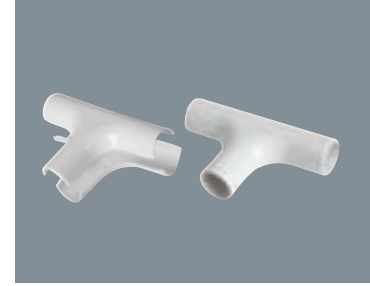

T Eki / T Corner

Ürün Kodu Product Code	Çap Diameter	Ambalaj Packaging
DLX 831 16	Ø 16	100 Ad./Pcs.
DLX 831 20	Ø 20	100 Ad./Pcs.
DLX 831 25	Ø 25	50 Ad./Pcs.
DLX 831 32	Ø 32	50 Ad./Pcs.

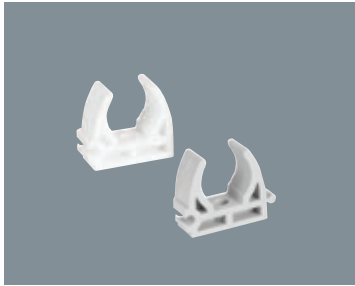

Ay Kroşe / Snap Clip

Ürün Kodu Product Code	Çap Diameter	Ambalaj Packaging
DLX 841 16	Ø 16	100 Ad./Pcs.
DLX 841 20	Ø 20	100 Ad./Pcs.
DLX 841 25	Ø 25	100 Ad./Pcs.
DLX 841 32	Ø 32	100 Ad./Pcs.



PVC Düz Boru Rakoru PVC Rigit Pipe Adapter

Ürün Kodu Product Code	Çap Diameter	Ambalaj Packaging
DLX 875 16	Ø 16	100 Ad./Pcs.
DLX 875 20	Ø 20	100 Ad./Pcs.
DLX 875 25	Ø 25	100 Ad./Pcs.
DLX 875 32	Ø 32	100 Ad./Pcs.



90° Dirsek / 90° Corner

Ürün Kodu Product Code	Çap Diameter	Ambalaj Packaging
DLX 821 16-L	Ø 16	100 Ad./Pcs.
DLX 821 20-L	Ø 20	100 Ad./Pcs.
DLX 821 25-L	Ø 25	50 Ad./Pcs.
DLX 821 32-L	Ø 32	50 Ad./Pcs.

ANAHTAR PRİZ KASALARI / SWITCH AND PLUG BOXES

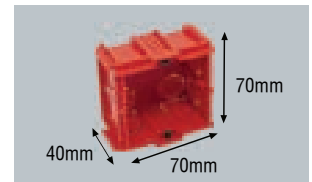

Sıva Altı Modüler Kasa Flush Mounting Module Case

Ürün Kodu Product Code	Açıklama Description	Ambalaj Packaging
880 19	Sıva Altı Modüler Kasa Flush Mounting Module Case	500

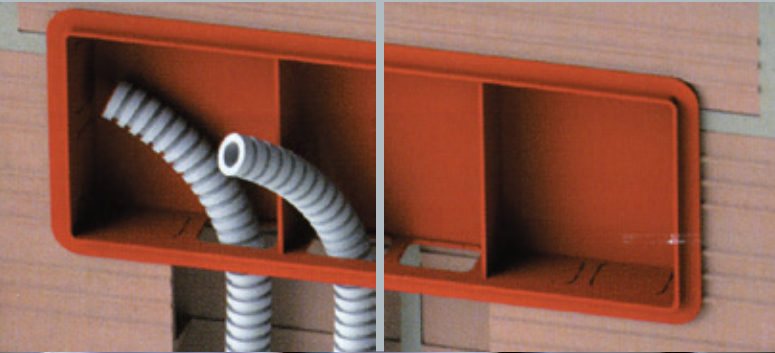
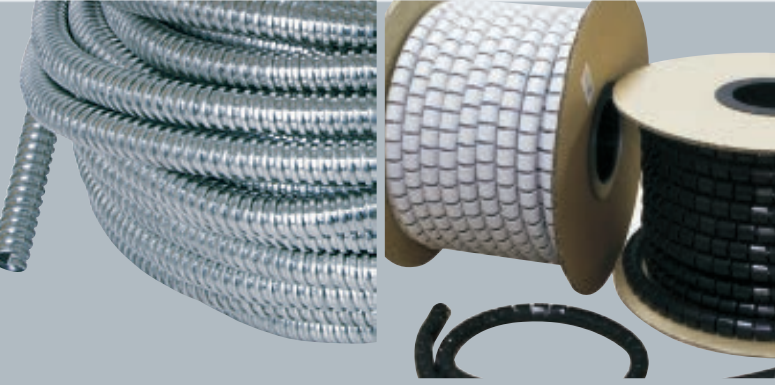

ELEKTRİK SİRAL BORULARI
ELECTRICAL INSTALLATION
CORRUGATED CONDUITS

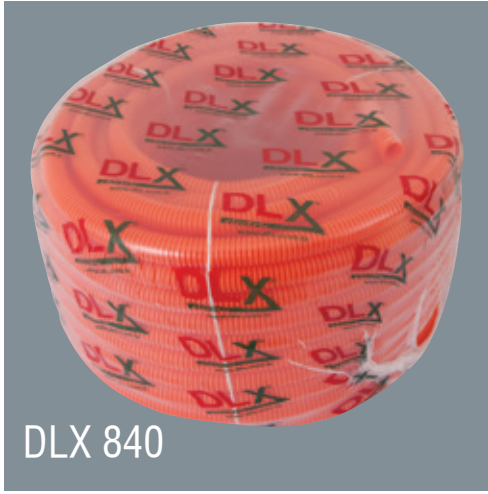
ELEKTRİK TESİSAT BORULARI
ELECTRICAL INSTALLATION CONDUITS**DLX 840****PE Spiral Boru**
PE Corrugated Conduit**Halojeniz**

DLX 840 Kullanım Alanları : Her türlü elektrik tesisatında mekanik zorlamaların fazla olmadığı yerlerde, bina, prefabrik yapılarda, sıva altı ve sıva üstü tüm uygulamalarda, beton içerisinde, alçıpan, duvar ya da asma tavan içerisinde, özellikle tünel kalıp sistemlerinde ve yükseltilmiş döşeme uygulamalarında.

Halogen free

DLX 840 Field of Application: Used in applications on walls, under the plaster; in all kinds of concrete floor and ceiling slabs, on suspended ceilings and under areas where low mechanical shocks and loadings are expected and also available for raised floor.

Renk Kod No / Color Code**Siyah**
Black
Ral 9005**Gri**
Grey
Ral 7035**Mavi**
Blue
Ral 5017**Turuncu**
Orange
Ral 2004**Beyaz**
White
Ral 9016**PE SİRİRAL BORU / PE CORRUGATED CONDUIT**

Ürün Kodu Product Code	Dış Çap (mm) Ex. Diameter (mm)	İç Çap (mm) Int. Diameter (mm)	Ambalaj / m Package / m
DLX 840 16	Ø 16	11,2	100
DLX 840 20	Ø 20	14,5	100
DLX 840 25	Ø 25	19,0	50
DLX 840 32	Ø 32	24,8	50
DLX 840 40	Ø 40	32,20	25



*320 N Kuvvet dayanımına sahip ürünlerde mevcuttur. / Available on products rated for a load capacity of 320 N.

Teknik Özellikler

Standart	: EN 61386-21 / 22
Malzeme	: PE Bazlı Termoplastik
Sıkıştırma Dayanımı	: 750 Newton / 60 sn./sec / 23± 2°C
Darbe Dayanımı	: 2 kg. / 100 mm / -25°C
Çalışma Ortamı Sıcaklığı	: - 25°C + 60°C
Yalıtım Gerilimi	: 2000 V. / 50 Hz. / 15 dak.

Technical Details

Standard	: EN 61386-21 / 22
Material	: PE Based Thermoplastic
Compression Resistance	: 750 Newton / 60 sn./sec / 23± 2°C
Impact Resistance	: 2 kg. / 100 mm / -25°C
Working Temperature	: - 25°C + 60°C
Insulating Strength	: 2000 V. / 50 Hz. / 15 min.

ELEKTRİK TESİSAT BORULARI
ELECTRICAL INSTALLATION CONDUITS**DLX 860****PP Spiral Boru**
PP Corrugated Conduit**Halojeniz Alev Yaymayan**

DLX 860 Kullanım Alanları : Her türlü elektrik tesisatında mekanik zorlamaların fazla olmadığı yerlerde, bina, prefabrik yapılarda, sıva altı ve sıva üstü tüm uygulamalarda, beton içerisinde, alçıpan, duvar ya da asma tavan içerisinde, özellikle tünel kalıp sistemlerinde ve yükseltilmiş döşeme uygulamalarında.

Self Extinguishing Halogen free

DLX 860 Field of Application: Used in applications on walls, under the plaster; in all kinds of concrete floor and ceiling slabs, on suspended ceilings and under areas where low mechanical shocks and loadings are expected and also available for raised floor.

Renk Kod No / Color Code**Siyah**
Black
Ral 9005**Gri**
Grey
Ral 7035**Mavi**
Blue
Ral 5017**Beyaz**
White
Ral 9016**PP SPİRAL BORU / PE CORRUGATED CONDUIT**

Ürün Kodu Product Code	Dış Çap (mm) Ex. Diameter (mm)	İç Çap (mm) Int. Diameter (mm)	Ambalaj / m Package / m
DLX 860 16	Ø 16	11,2	100
DLX 860 20	Ø 20	14,5	100
DLX 860 25	Ø 25	19,0	50
DLX 860 32	Ø 32	24,8	50
DLX 860 40	Ø 40	32,20	25

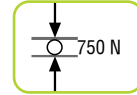

*320 N Kuvvet dayanımına sahip ürünlerde mevcuttur. / Available on products rated for a load capacity of 320 N.

**Teknik Özellikler**

Standart	: EN 61386-21 / 22
Malzeme	: PP Bazlı Termoplastik
Sıkıştırma Dayanımı	: 750 Newton / 60 sn./sec / 23± 2°C
Darbe Dayanımı	: 2 kg. / 100 mm / -25°C
Çalışma Ortamı Sıcaklığı	: - 25°C + 60°C
Yalıtım Gerilimi	: 2000 V. / 50 Hz. / 15 dak.

Technical Details

Standard	: EN 61386-21 / 22
Material	: PP Based Thermoplastic
Compression Resistance	: 750 Newton / 60 sn./sec / 23± 2°C
Impact Resistance	: 2 kg. / 100 mm / -25°C
Working Temperature	: - 25°C + 60°C
Insulating Strength	: 2000 V. / 50 Hz. / 15 min.

ELEKTRİK TESİSAT BORULARI
ELECTRICAL INSTALLATION CONDUITS



PE Spiral Boru Klavuz Telli
PE Corrugated Conduit the guide wire

Halojensiz

DLX 849 Kullanım Alanları : Her türlü elektrik tesisatında mekanik zorlamaların fazla olmadığı yerlerde, bina, prefabrik yapılarda, sıva altı ve sıva üstü tüm uygulamalarda, beton içerisinde, alçıpan, duvar ya da asma tavan içerisinde, özellikle tünel kalıp sistemlerinde ve yükseltilmiş döşeme uygulamalarında.

Halogen free

DLX 849 Field of Application: Used in applications on walls, under the plaster; in all kinds of concrete floor and ceiling slabs, on suspended ceilings and under areas where low mechanical shocks and loadings are expected and also available for raised floor.

Renk Kod No / Color Code



PE SİRİAL BORU / PE CORRUGATED CONDUIT

Ürün Kodu Product Code	Dış Çap (mm) Ex. Diameter (mm)	İç Çap (mm) Int. Diameter (mm)	Ambalaj / m Package / m
DLX 849 16	Ø 16	11,2	100
DLX 849 20	Ø 20	14,5	100
DLX 849 25	Ø 25	19,0	50
DLX 849 32	Ø 32	24,8	50
DLX 849 40	Ø 40	32,20	25



*320 N Kuvvet dayanımına sahip ürünlerde mevcuttur. / Available on products rated for a load capacity of 320 N.



Teknik Özellikler

Standart	: EN 61386-21 / 22
Malzeme	: PE Bazlı Termoplastik
Sıkıştırma Dayanımı	: 750 Newton / 60 sn./sec / 23± 2°C
Darbe Dayanımı	: 2 kg. / 100 mm / -25°C
Çalışma Ortamı Sıcaklığı	: - 25°C + 60°C
Yalıtım Gerilimi	: 2000 V. / 50 Hz. / 15 dak.

Technical Details

Standard	: EN 61386-21 / 22
Material	: PE Based Thermoplastic
Compression Resistance	: 750 Newton / 60 sn./sec / 23± 2°C
Impact Resistance	: 2 kg. / 100 mm / -25°C
Working Temperature	: - 25°C + 60°C
Insulating Strength	: 2000 V. / 50 Hz. / 15 min.

ELEKTRİK TESİSAT BORULARI
ELECTRICAL INSTALLATION CONDUITS**DLX 869****PP Spiral Boru Klavuz Telli**
PP Corrugated Conduit the guide wire**Halojensiz Alev Yaymayan**

DLX 869 Kullanım Alanları : Her türlü elektrik tesisatında mekanik zorlamaların fazla olmadığı yerlerde, bina, prefabrik yapılarda, sıva altı ve sıva üstü tüm uygulamalarda, beton içerisinde, alçıpan, duvar ya da asma tavan içerisinde, özellikle tünel kalıp sistemlerinde ve yükseltilmiş döfleme uygulamalarında.

Self Extinguishing Halogen free

DLX 869 Field of Application: Used in applications on walls, under the plaster; in all kinds of concrete floor and ceiling slabs, on suspended ceilings and under areas where low mechanical shocks and loadings are expected and also available for raised floor.

Renk Kod No / Color Code**Siyah**
Black
Ral 9005**Gri**
Grey
Ral 7035**Mavi**
Blue
Ral 5017**Beyaz**
White
Ral 9016**PP SPİRAL BORU / PE CORRUGATED CONDUIT**

Ürün Kodu Product Code	Dış Çap (mm) Ex. Diameter (mm)	İç Çap (mm) Int. Diameter (mm)	Ambalaj / m Package / m
DLX 869 16	Ø 16	11,2	100
DLX 869 20	Ø 20	14,5	100
DLX 869 25	Ø 25	19,0	50
DLX 869 32	Ø 32	24,8	50
DLX 869 40	Ø 40	32,20	25

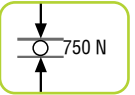

*320 N Kuvvet dayanımına sahip ürünlerde mevcuttur. / Available on products rated for a load capacity of 320 N.

**Teknik Özellikler**

Standart	: EN 61386-21 / 22
Malzeme	: PP Bazlı Termoplastik
Sıkıştırma Dayanımı	: 750 Newton / 60 sn./sec / 23± 2°C
Darbe Dayanımı	: 2 kg. / 100 mm / -25°C
Çalışma Ortamı Sıcaklığı:	- 25°C + 60°C
Yalıtım Gerilimi	: 2000 V. / 50 Hz. / 15 dak.

Technical Details

Standard	: EN 61386-21 / 22
Material	: PP Based Thermoplastic
Compression Resistance	: 750 Newton / 60 sn./sec / 23± 2°C
Impact Resistance	: 2 kg. / 100 mm / -25°C
Working Temperature	: - 25°C + 60°C
Insulating Strength	: 2000 V. / 50 Hz. / 15 min.

ELEKTRİK TESİSAT BORU AKSESUARLARI
ELECTRICAL INSTALLATION CONDUIT ACCESSORIES**Spiral Boru Rakoru**
Spiral Pipe Adapter

Ürün Kodu Product Code	Dış Çap (mm) Ex. Diameter (mm)	İç Çap (mm) Int. Diameter (mm)	Ambalaj / adet Packaging / pcs
DLX 878 16	2,5	10,0-14,0	100
DLX 878 20	3,0	15,0-19,0	100
DLX 878 25	4,4	21,0-25,0	100
DLX 878 32	1,0	28,3-32,3	100

**Spiral Boru Mufu**
Spiral Pipe Coupling

Ürün Kodu Product Code	Dış Çap (mm) Ex. Diameter (mm)	İç Çap (mm) Int. Diameter (mm)	Ambalaj / adet Packaging / pcs
DLX 876 16	1,5	16,4	100
DLX 876 20	1,5	20,5	100
DLX 876 25	2	25,5	100
DLX 876 32	2	32,5	100
DLX 876 40	2	41	100

**Kablo Toplama Spirali**
Spiral Cable Wrap

Ürün Kodu Product Code	İç Çap (mm) Int. Diameter (mm)	Ambalaj / adet Packaging / pcs
DLX 877 20	20 (1,5mt)	1
DLX 877 31	25 (1,5mt)	1
DLX 877 32	30 (1,5mt)	1
DLX 877 33	Aksesuar (20mm)	1

**Kablo Toplama Spirali**
Spiral Cable Wrap

Ürün Kodu Product Code	İç Çap (mm) Int. Diameter (mm)	Ambalaj / m Packaging / m
DLX 877 22	20	25
DLX 877 28	25	20
DLX 877 30	30	15

KABLO KANAL DÜBELLERİ
CABLE TRUNKING SCREW SOCKETS



910 10

Kablo Kanalı Dübeli
Cable Trunking Screw Socket
Ambalaj: 500 Adet
Packaging: 500m



910 11

Alçıpan dübeli
Screwed Plaster
Ambalaj: 500 Adet
Packaging: 500m



910 12

Dübel 7mm
Screw Socket
Ambalaj: 1000 Adet
Packaging: 1000m



910 13

Dübel 8mm
Screw Socket
Ambalaj: 1000 Adet
Packaging: 1000pcs



910 14

Kablo kanalı Vidası
5x40mm
Cable Trunking Screw 5x40mm
Ambalaj: 144 Adet
Packaging: 144 pcs



910 15

Kablo kanalı Vidası
5x50mm
Cable Trunking Screw 5x50mm
Ambalaj: 144 Adet
Packaging: 144 pcs



910 16

Kablo kanalı pulu
3x16 mm
Cable Trunking Screw Washer
Ambalaj: 500 Adet
Packaging: 500pcs





DDLX FLEX
DLX FLEX



Malzeme: Polyamid PA6
Renk: Siyah (RAL9005) / Gri (RAL7031)
Sıcaklık Aralığı: -40 °C +120 °C
Yanmazlık sınıfı: UL94 V2
Özellikler:
• Halojen free
• Roshe uyumlu
• Yüksek UV dayanım
• Yüksek darbe dayanımı

Material: Polyamide PA6
Color: Black (RAL 9005) / Grey (RAL 7031)
Temperature Range: -40 °C to +120 °C
Flammability Rating: UL94 V2
Specifications:
• Halogen-free
• RoHS compliant
• High UV resistance
• High impact resistance

POLYAMID (PA 6) SPIRAL BORU
POLYAMIDE ELECTRICAL INSTALLATION CONDUITS

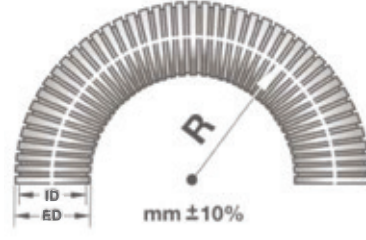
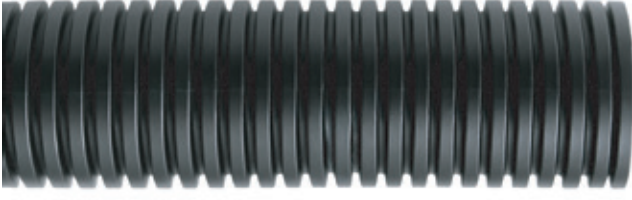

PG mm.	ÜRÜN KODU (SİYAH) Product Code (Black)	ÜRÜN KODU (GRİ) Product Code (Grey)	İÇ ÇAP (mm) Internal Diameter (mm)	DIŞ ÇAP (mm) External Diameter (mm)	AMBALAJ (mt) Packing (mt)
PG 7	REF 700 07 B	REF 700 07 G	6,5	10	100 mt
PG 8,5	REF 700 85 B	REF 700 85 G	8,5	12	100 mt
PG 9	REF 700 09 B	REF 700 09 G	10	13	100 mt
PG 11	REF 700 11 B	REF 700 11 G	12	15,8	50 mt
PG 13,5	REF 701 35 B	REF 701 35 G	14,2	18,5	50 mt
PG 16	REF 700 16 B	REF 700 16 G	16,5	21,2	50 mt
PG 21	REF 700 21 B	REF 700 21 G	23,5	28,4	50 mt
PG 26	REF 700 26 B	REF 700 26 G	26	30,9	50 mt
PG 29	REF 700 29 B	REF 700 29 G	29	34,5	25 mt
PG 36	REF 700 36 B	REF 700 36 G	36	42,5	25 mt
PG 48	REF 700 48 B	REF 700 48 G	48	54,5	25 mt

POLYAMID YARIKLI SPIRAL BORU
POLYAMIDE SPLIT TYPE SPIRAL CONDUITS

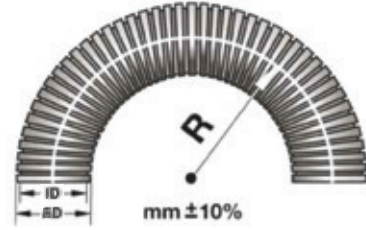
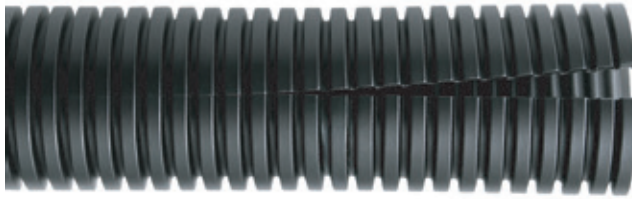

PG mm.	ÜRÜN KODU (SİYAH) Product Code (Black)	ÜRÜN KODU (GRİ) Product Code (Grey)	İÇ ÇAP (mm) Internal Diameter (mm)	DIŞ ÇAP (mm) External Diameter (mm)	AMBALAJ (mt) Packing (mt)
PG 7	REF 710 07 B	REF 710 07 G	6,5	10	100 mt
PG 8,5	REF 710 85 B	REF 710 85 G	8,5	12	100 mt
PG 9	REF 710 09 B	REF 710 09 G	10	13	100 mt
PG 11	REF 710 11 B	REF 710 11 G	12	15,8	50 mt
PG 13,5	REF 711 35 B	REF 711 35 G	14,2	18,5	50 mt
PG 16	REF 710 16 B	REF 710 16 G	16,5	21,2	50 mt
PG 21	REF 710 21 B	REF 710 21 G	23,5	28,4	50 mt
PG 26	REF 710 26 B	REF 710 26 G	26	30,9	50 mt
PG 29	REF 710 29 B	REF 710 29 G	29	34,5	25 mt
PG 36	REF 710 36 B	REF 710 36 G	36	42,5	25 mt
PG 48	REF 710 48 B	REF 710 48 G	48	54,5	25 mt

PG DİŞ GEÇMELİ TİP SİRİAL REKORLAR
PG THREADED FLEXIBLE CONDUIT GLANDS

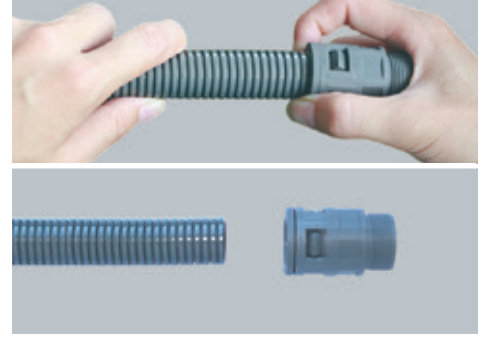
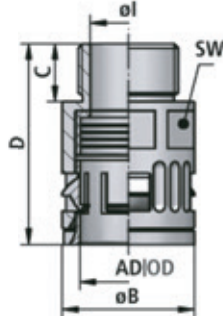

AG mm.	ÜRÜN KODU (SİYAH) Product Code (Black)	ÜRÜN KODU (GRİ) Product Code (Grey)	SİRİAL ÖLÇÜ (mm) Spiral Diameter (mm)	D mm.	ØI mm.	ØB mm.	mm.	AMBALAJ/Ad Packing (Pcs)
PG 7	REF 720 07 B	REF 720 07 G	6,5 x 10	37	6,9	18,7	15	150
PG 9	REF 720 09 B	REF 720 09 G	10 x 13	37	10,3	21,7	18	100
PG 11	REF 720 11 B	REF 720 11 G	12 x 15,8	37,5	13,3	26	20	70
PG 13,5	REF 721 35 B	REF 721 35 G	14,2 x 18,4	42	15,3	28	23	50
PG 16	REF 720 16 B	REF 720 16 G	16,5 x 21,2	46	16,6	32	27	40
PG 21	REF 720 21 B	REF 720 21 G	23,5 x 28,4	55	22,3	39,5	34	20
PG 29	REF 720 29 B	REF 720 29 G	29 x 34,5	59	31,7	46,5	40	15
PG 36	REF 720 36 B	REF 720 36 G	36 x 42,5	61,5	40,5	55,5	50	12
PG 48	REF 720 48 B	REF 720 48 G	48 x 54,5	63,5	51,7	67,5	62	8

POLYAMİD KROŞE / POLYAMIDE MOUNTING HOOK

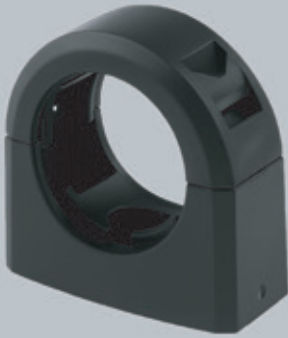

AG mm.	ÜRÜN KODU (SİYAH) Product Code (Black)	ÜRÜN KODU (GRİ) Product Code (Grey)	SİRİAL ÖLÇÜ (mm) Spiral Diameter (mm)	AMBALAJ/Ad Packing (Pcs)
PG 7	REF 730 07 B	REF 730 07 G	6,5 x 10	50
PG 9	REF 730 09 B	REF 730 09 G	10 x 13	50
PG 11	REF 730 11 B	REF 730 11 G	12 x 15,8	50
PG 13,5	REF 731 35 B	REF 731 35 G	14,2 x 18,4	50
PG 16	REF 730 16 B	REF 730 16 G	16,5 x 21,2	50
PG 21	REF 730 21 B	REF 730 21 G	23,5 x 28,4	25
PG 29	REF 730 29 B	REF 730 29 G	29 x 34,5	25
PG 36	REF 730 36 B	REF 730 36 G	36 x 42,5	25
PG 48	REF 730 48 B	REF 730 48 G	48 x 54,5	10

POLYAMİD KÖRTAPA / POLYAMIDE PG THREADED BLIND PLUG

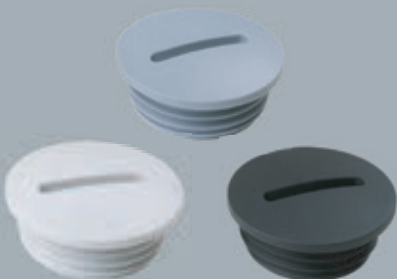

AG mm.	ÜRÜN KODU (SİYAH) Product Code (Black)	ÜRÜN KODU (GRİ) Product Code (Grey)	MONTAL ÇAP (mm) Mounting Diameter (mm)	AMBALAJ/Ad Packing (Pcs)
PG 7	REF 740 07 B	REF 740 07 G	13	100
PG 9	REF 740 09 B	REF 740 09 G	16	100
PG 11	REF 740 11 B	REF 740 11 G	19	100
PG 13,5	REF 741 35 B	REF 741 35 G	21	100
PG 16	REF 740 16 B	REF 740 16 G	23	100
PG 21	REF 740 21 B	REF 740 21 G	29	50
PG 29	REF 740 29 B	REF 740 29 G	37,5	50
PG 36	REF 740 36 B	REF 740 36 G	47,5	50
PG 48	REF 740 48 B	REF 740 48 G	60	50

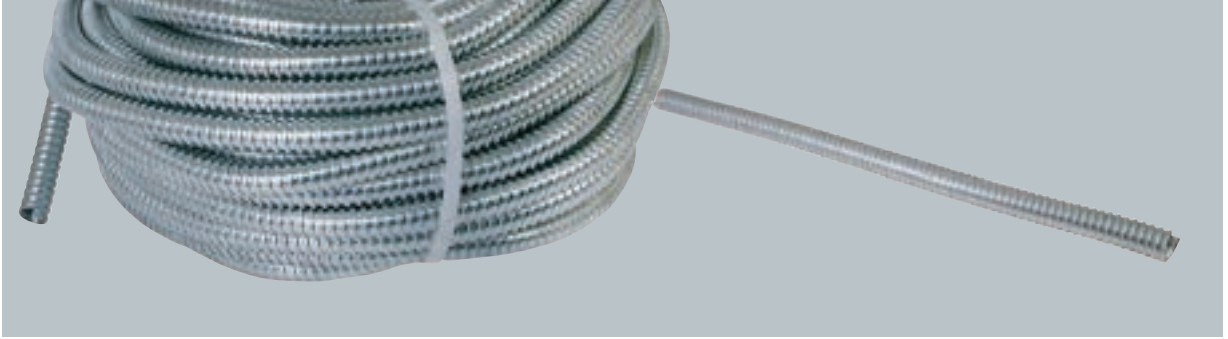
ÇELİK SİRALLER
STEEL TUBES**ÇELİK SİRALLER / STEEL TUBES**

Ürün Kodu Product Code	Nominal Çap Nominal Diameter	İç Çap (mm) Int. Diameter (mm)	Dış Çap (mm) Ex. Diameter (mm)	Ambalaj / adet Packaging / pcs
871 09	Ø 9	9	11,5	50 m
871 11	Ø 11	11	14	50 m
871 14	Ø 14	14	17	50 m
871 16	Ø 16	16	19	50 m
871 18	Ø 18	18	21	25 m
871 26	Ø 26	26	29	25 m
871 29	Ø 29	29	32	25 m
871 37	Ø 37	37	41	25 m
871 40	Ø 40	40	48	25 m
871 50	Ø 50	50	55	25 m

- Hammedde: Kalaylı Çelik • Çalışma Sıcaklığı : -25° +150°
- Material : Tin-Coated Steel • Working Temperature: -25° +150°

PVC KAPLI ÇELİK SİRALLER / PVC COATED STEEL TUBES

Ürün Kodu Product Code	Nominal Çap Nominal Diameter	İç Çap (mm) Int. Diameter (mm)	Dış Çap (mm) Ex. Diameter (mm)	Ambalaj / adet Packaging / pcs
873 09	Ø 9	9	11,5	50 m
873 11	Ø 11	11	14	50 m
873 14	Ø 14	14	17	50 m
873 16	Ø 16	16	19	50 m
873 18	Ø 18	18	21	50 m
873 26	Ø 26	26	29	25 m
873 29	Ø 29	29	32	25 m
873 37	Ø 37	37	41	25 m
873 40	Ø 40	40	48	25 m
873 50	Ø 50	50	55	25 m

- Hammedde: Kaylı Çelik + Termo plastik PVC • Çalışma Sıcaklığı : -25° +80°
- Material : Tin-Coated Steel + Termo plastic PVC • Working Temperature: -25° +80°

GALVANİZLİ ÇELİK SPİRALLER
GALVENISED STEEL TUBE

GALVANİZLİ ÇELİK SPİRALLER / GALVENISED STEEL TUBES



Ürün Kodu Product Code	Nominal Çap Nominal Diameter	İç Çap (mm) Int. Diameter (mm)	Dış Çap (mm) Ex. Diameter (mm)	Ambalaj / adet Packaging / pcs
872 09	Ø 9	9	11,5	50 m
872 11	Ø 11	11	14	50 m
872 14	Ø 14	14	17	50 m
872 16	Ø 16	16	19	50 m
872 18	Ø 18	18	21	50 m
872 26	Ø 26	26	29	25 m
873 29	Ø 29	29	32	25 m
872 37	Ø 37	37	41	25 m
872 40	Ø 40	40	48	25 m
872 50	Ø 50	50	55	25 m

- Hammadde: Kalaylı Çelik • Çalışma Sıcaklığı : -25° +150°
- Material : Tin-Coated Steel • Working Temperature: -25° +150°

PVC KAPLI GALVANİZLİ ÇELİK SPİRALLER / PVC COATED GALVENISED STEEL TUBES



Ürün Kodu Product Code	Nominal Çap Nominal Diameter	İç Çap (mm) Int. Diameter (mm)	Dış Çap (mm) Ex. Diameter (mm)	Ambalaj / adet Packaging / pcs
874 09	Ø 9	9	11,5	50 m
874 11	Ø 11	11	14	50 m
874 14	Ø 14	14	17	50 m
874 16	Ø 16	16	19	50 m
874 18	Ø 18	18	21	50 m
874 26	Ø 26	26	29	25 m
874 29	Ø 29	29	32	25 m
874 37	Ø 37	37	41	25 m
874 40	Ø 40	40	48	25 m
874 50	Ø 50	50	55	25 m

- Hammadde: Kaylı Çelik + Termo plastik PVC • Çalışma Sıcaklığı : -25° +80°
- Material : Tin-Coated Steel + Termo plastic PVC • Working Temperature: -25° +80°

ÇELİK SPİRALLER STEEL TUBES

LIQUID TIGHT GALVANİZLİ ÇELİK SPİRAL LIQUID TIGHT GALVANIZED STEEL TUBES



Ürün Kodu Product Code	Nominal Çap Nominal Diameter	İç Çap (mm) Int. Diameter (mm)	Dış Çap (mm) Ex. Diameter (mm)	Ambalaj / adet Packaging / pcs
876 10	Ø 10	1/4" Ø10	14	30 m
876 13	Ø 13	3/8" Ø13	17	30 m
876 16	Ø 16	1/2" Ø16	21	30 m
876 21	Ø 21	3/4" Ø21	26	30 m
876 26	Ø 26	1" Ø26	32	30 m
876 35	Ø 35	1 1/4" Ø35	41	15 m
876 40	Ø 40	1 1/2" Ø40	47	15 m
876 52	Ø 52	2" Ø52	59	15 m
876 63	Ø 63	2 1/2" Ø63	72	15 m
876 78	Ø 78	3" Ø78	88	7.5 m
876 12	Ø 102	4" Ø102	112	7.5 m

HALOJEN FREE PLASTİK KAPLI ÇELİK SPİRAL HALOJEN FREE PLASTIC COATED STEEL TUBES

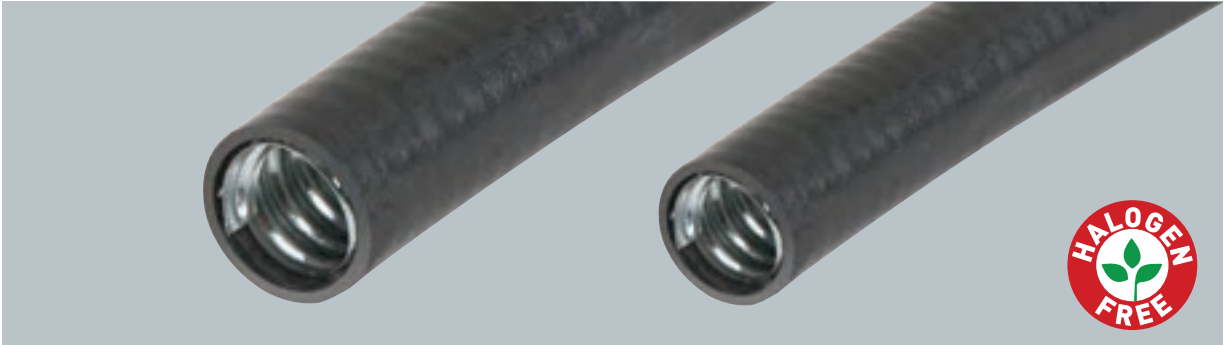

Ürün Kodu Product Code	Nominal Çap Nominal Diameter	İç Çap (mm) Int. Diameter (mm)	Dış Çap (mm) Ex. Diameter (mm)	Ambalaj / adet Packaging / pcs
877 09	Ø 9	9	11,5	50 m
877 11	Ø 11	11	14	50 m
877 14	Ø 14	14	17	50 m
877 16	Ø 16	16	19	50 m
877 18	Ø 18	18	21	50 m
877 26	Ø 26	26	29	25 m
877 29	Ø 29	29	32	25 m
877 37	Ø 37	37	41	25 m
877 40	Ø 40	40	48	25 m
877 50	Ø 50	50	55	25 m
877 63	Ø 63	63	70	25 m

DLX[®]
electric
ABS- PC PANOLAR

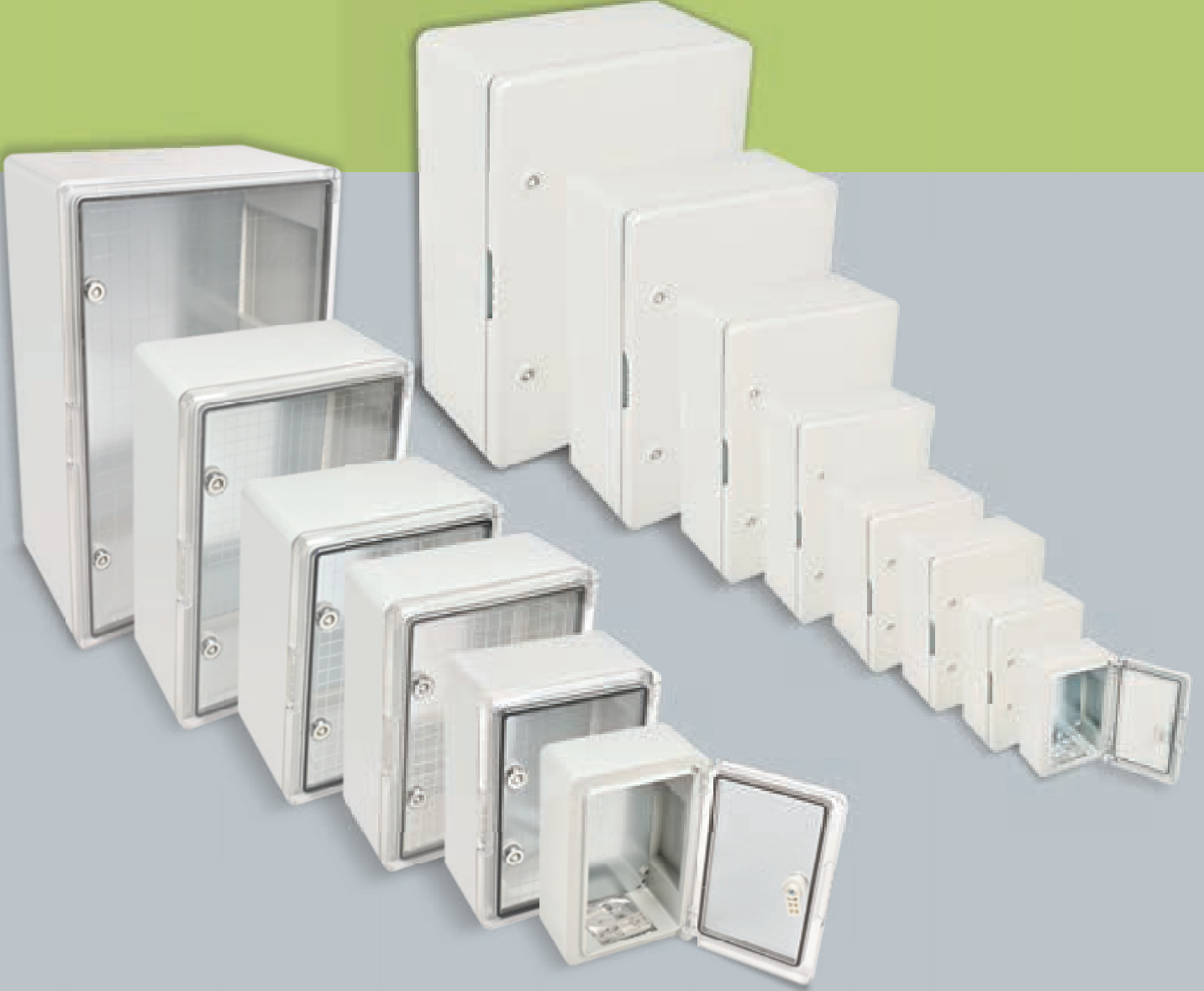

Ambalaj: 16m
Uzunluk 2m Kesit: 102x50
Kapaklı satılır. 3 ara bölme takılabilir.
Renk RAL 9010-9016 Beyaz

Packaging Unit: 16m
2m length, Dimensions: 102x50
Complete with cover. Up to 3 divider possibility
Color RAL 9010-9016 White

OPAK KAPAKLI, GALVANİZ TABAN SAÇLI ABS PANO
ABS ENCLOSURES OPAQUE COVER WITH GALVANISE BASE PLATE



REFERANS	BOYUT DIMENSIONS (AxBxC) (mm)	AMBALAJ PACKAGE
REF 998 01	200 X 300 X 130 mm	1ad/pcs
REF 998 02	250 X 350 X 150 mm	1ad/pcs
REF 998 03	300 X 400 X 170 mm	1ad/pcs
REF 998 04	300 X 400 X 220 mm	1ad/pcs
REF 998 05	350 X 500 X 190 mm	1ad/pcs
REF 998 06	400 X 500 X 180 mm	1ad/pcs
REF 998 07	400 X 500 X 240 mm	1ad/pcs
REF 998 08	400 X 600 X 200 mm	1ad/pcs
REF 998 09	500 X 600 X 230 mm	1ad/pcs
REF 998 10	500 X 700 X 250 mm	1ad/pcs
REF 998 11	600 X 800 X 280 mm	1ad/pcs



ŞEFFAF POLİKARBONAT KAPAK, GALVANİZ TABAN SAÇLI ABS PANO
POLYCARBONATE TRANSPARENT COVER, ABS ENCLOSURES WITH GALVANISE BASE PLATE



REFERANS	BOYUT DIMENSIONS (AxBxC) (mm)	AMBALAJ PACKAGE
REF 999 01	200 X 300 X 130 mm	1ad/pcs
REF 999 02	250 X 350 X 150 mm	1ad/pcs
REF 999 03	300 X 400 X 170 mm	1ad/pcs
REF 999 04	300 X 400 X 220 mm	1ad/pcs
REF 999 05	350 X 500 X 190 mm	1ad/pcs
REF 999 06	400 X 500 X 180 mm	1ad/pcs
REF 999 07	400 X 500 X 240 mm	1ad/pcs
REF 999 08	400 X 600 X 200 mm	1ad/pcs
REF 999 09	500 X 600 X 230 mm	1ad/pcs
REF 999 10	500 X 700 X 250 mm	1ad/pcs
REF 999 11	600 X 800 X 280 mm	1ad/pcs

OPAK KAPAKLI ABS DAĞITIM PANOLARI PERDELİ
ABS DISTRIBUTION ENCLOSURES WITH OPAQUE COVER

REFERANS	BOYUT DIMENSIONS (AxBxC) (mm)	AMBALAJ PACKAGE
REF 998 12	250 X 350 X 150 mm	1ad/pcs
REF 998 13	300 X 400 X 170 mm	1ad/pcs
REF 998 14	350 X 500 X 190 mm	1ad/pcs
REF 998 15	400 X 600 X 200 mm	1ad/pcs

ŞEFFAF KAPAKLI ABS DAĞITIM PANOLARI PERDELİ
ABS DISTRIBUTION ENCLOSURES WITH TRANSPARENT PC COVER

REFERANS	BOYUT DIMENSIONS (AxBxC) (mm)	AMBALAJ PACKAGE
REF 999 12	250 X 350 X 150 mm	1ad/pcs
REF 999 13	300 X 400 X 170 mm	1ad/pcs
REF 999 14	350 X 500 X 190 mm	1ad/pcs
REF 999 15	400 X 600 X 200 mm	1ad/pcs

OPAK KAPAKLI, PLASTİK TABANLI ABS PANO
ABS ENCLOSURES OPAQUE COVER WITH PLASTIC BASE PLATE



REFERANS	BOYUT DIMENSIONS (AxBxC) (mm)	AMBALAJ PACKAGE
REF 998 16	200 X 300 X 130 mm	1ad/pcs
REF 998 17	250 X 350 X 150 mm	1ad/pcs
REF 998 18	300 X 400 X 170 mm	1ad/pcs
REF 998 19	300 X 400 X 220 mm	1ad/pcs
REF 998 20	350 X 500 X 190 mm	1ad/pcs
REF 998 21	400 X 500 X 180 mm	1ad/pcs
REF 998 22	400 X 500 X 240 mm	1ad/pcs
REF 998 23	400 X 600 X 200 mm	1ad/pcs
REF 998 24	500 X 600 X 230 mm	1ad/pcs
REF 998 25	500 X 700 X 250 mm	1ad/pcs



ŞEFFAF POLİKARBONAT KAPAK, PLASTİK TABANLI ABS PANO
POLYCARBONATE TRANSPARENT COVER, ABS ENCLOSURES WITH PLASTIC BASE PLATE



REFERANS	BOYUT DIMENSIONS (AxBxC) (mm)	AMBALAJ PACKAGE
REF 999 16	200 X 300 X 130 mm	1ad/pcs
REF 999 17	250 X 350 X 150 mm	1ad/pcs
REF 999 18	300 X 400 X 170 mm	1ad/pcs
REF 999 19	300 X 400 X 220 mm	1ad/pcs
REF 999 20	350 X 500 X 190 mm	1ad/pcs
REF 999 21	400 X 500 X 180 mm	1ad/pcs
REF 999 22	400 X 500 X 240 mm	1ad/pcs
REF 999 23	400 X 600 X 200 mm	1ad/pcs
REF 999 24	500 X 600 X 230 mm	1ad/pcs
REF 999 25	500 X 700 X 250 mm	1ad/pcs

CAM ELYAF TAKVİYELİ ELEKTRİK DAĞITIM PANOSU
GLASS REINFORCED POLYESTER ELECTRICAL DISTRIBUTION BOARD

Ref:310 08
600x800x220



Ref:310 07
500x700x200



Ref:310 06
400x600x200



Ref:310 05
350x500x170



Ref:310 04
300x400x170



Ref:310 02
250x300x170



Ref:310 01
200x300x120

KİLİT SEÇENEKLERİ
LOCK OPTIONS

Pako Kilit
Paco Lock



Asma Kilit Hamili
Çeyrek Dönüşlü Kilit
Padlockable
Wing Knob



Silindirik
Kelebek Kilit
Cam Lock-Wing
Knob



Yaylı Pano Kilidi
Kelebek (Metal Klipsli)
Quarter Turn
With Wing Knob
(Metal Clip)



Yaylı Pano Kilidi (Plastik Üçgen)
Quarter Turn With Spring
(Plastic Triangular)

Standart Kilit Sistemi
Standard Locking System

CAM ELYAF TAKVİYELİ ELEKTRİK DAĞITIM PANOSU
GLASS REINFORCED POLYESTER ELECTRICAL DISTRIBUTION BOARD**GENEL ÖZELLİKLER COMMON SPECIFICATION**

- ✓ Paslanmaz, çizilmez, boya bakım gerektirmez.
- ✓ Elektrik iletmez, yalıtıcıdır.
- ✓ Alev iletmez ve kendiliğinden söner.
- ✓ Rutubet, nem barındırmaz.
- ✓ Atmosferik şartlara karşı dayanıklıdır.
- ✓ Üzerine logo istenildiği gibi yapılabilir.
- ✓ Rustproof, unscratched paint, no need painting & maintenance.
- ✓ Dielectric.
- ✓ Flameproof, self-extinguishing.
- ✓ Non-affected by humidity.
- ✓ Resistant to atmosphere conditions.
- ✓ Your logo can be placed on.

TEKNİK ÖZELLİKLER TECHNICAL SPECIFICATION

Ham madde	: Cam Elyaf Takviyeli Polyester	Raw Material	: Glass Reinforced Polyester
Kalite Standardı	: EN61439, EN60670-1	Quality Standart	: EN61439, EN60670-1
Renk	: RAL 7035 (Renk Seçenekleri vardır)	Color	: RAL 7035 (There are color options)
Çalışma Sıcaklığı	: -40°+70°C	Operating Temperature	: -40°+70°C
Kapak Açılma Açısı	: 210	Door Opening Angle	: 210
Menteşe	: 2/3 Adet	Hinge	: 2/3 Pieces
Kilit	: 1/2 Adet	Lock	: 1/2 Pieces
Kilit Seçenekleri	: Üçgen, Kelebek, Yaylı, Sıkıştırılmalı (metal veya plastik)	Lock Options	: Triangle, Butterfly, Springy, Compression (Metal or Plastic)
Koruma Kılıfı	: IP 54 / IP65	Protection Class	: IP 54 / IP65
Yangın Dayanımı	: B2 (İstenildiğinde A1, A2, B1, V0)	Fire Resistance	: B2 (Can change to A1, A2, B1, V0)
UV Dayanımı	: Talebe göre eklenebilir	UV Resistance	: Can be added acc.to request
Nem Dayanımı	: Evet	Humidity Resistance	: Yes
Kimyasal Dayanımı	: Asit ve Bazlara Karşı Tam Koruma	Chemical Resistance	: Full Protection Against acid and base
Aşınma Dayanımı	: Olumsuz hava koşullarına karşı yüksek dayanım	Corrosion Resistance	: High Resistance Against adverse weather conditions
Conta	: Poliüretan dökme conta veya EPDM conta	Gasket	: Polyurethane foam gasket or EPDM gasket
Topraklama Sınıfı	: Class II	Grounding Class	: Class II

DLX FIX ÇİVİLİ KROŞELER / DLX FIX NAIL CABLE CLIPS



Ref	No.	Açıklama / Descriptions	Paket Adet Bag Pcs.	Koli Adet Box Pcs.
771 00	0 (4 mm.)	0,75 Yassı Kablo 0,75 Cable	1.000	20.000
771 01	1 (4 mm.)	Kordon Kablo 0,75 Cable	1.000	20.000
771 02	2 (6 mm.)	Data Kablo Data Cable	1.000	20.000
771 03	3 (7 mm.)	2 x 1,5 - 3 x 1,5 TTR Kablo 2 x 1,5 - 3 x 1,5 TTR Cable	1.000	20.000
771 04	4 (8 mm.)	2 x 4 Antigrom Kablo 2 x 4 Antigrom Cable	1.000	20.000
771 05	5 (10 mm.)	2 x 4 - 4 x 4 Antigrom Kablo 2 x 4 - 4 x 4 Antigrom Cable	1.000	10.000
771 06	6 (12 mm.)	4 x 6 Antigrom Kablo 4 x 6 Antigrom Cable	1.000	10.000
771 07	7 (16 mm.)	4 x 10 Antigrom Kablo 4 x 10 Antigrom Cable	100	3.000
771 08	8 (25 mm.)	4 x 16 Antigrom Kablo 4 x 6 Antigrom Cable	100	2.000

PLASTİK SIRA KLEMENSLER / PP PLASTIC TERMINAL STRIPS

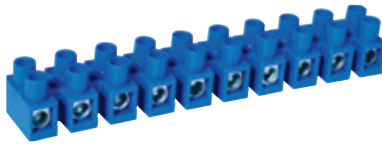

REF	No.	Açıklama Descriptions	Bağlantı Poles	A	W	Adet / Pcs. Packing
772 01	No 1	2,5-4 mm ²	12	32	400	50
772 02	No 2	4-6 mm ²	12	41	400	50
772 03	No 3	6-10 mm ²	10	57	400	50
772 04	No 4	10-16 mm ²	6	76	500	50
772 05	No 5	16-25 mm ²	6	101	500	50

Renk : Mavi, Siyah / MS 58 Piriç / Color : Blue, Black / MS 58 Bras
Çalışma Ortamı Sıcaklığı / Continuous Working Temperature 110 °C

ISIYA DAYANIKLI PLASTİK SIRA KLEMENSLER PA PLASTIC TERMINAL STRIPS

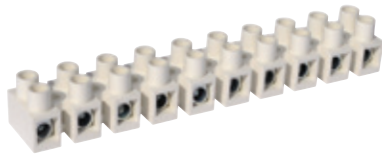

REF	No.	Açıklama Descriptions	Bağlantı Poles	A	W	Adet / Pcs. Packing
773 01	No 1	2,5-4 mm ²	12	32	400	50
773 02	No 2	4-6 mm ²	12	41	400	50
773 03	No 3	6-10 mm ²	10	57	400	50
773 04	No 4	10-16 mm ²	6	76	500	50
773 05	No 5	16-25 mm ²	6	101	500	50

Renk : Beyaz / MS 58 Piriç / Color : White / MS 58 Bras
Çalışma Ortamı Sıcaklığı / Continuous Working Temperature 140 °C

12'Lİ GEÇMELİ SOKET KLEMENS / 12 SOCKET CONNETORS WITH POLE (ONE-PIECE) TERMINAL STRIPS

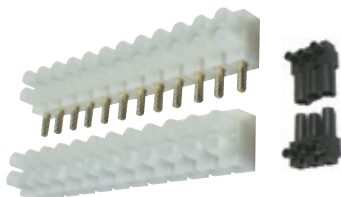

REF	Açıklama Descriptions	Adet / Pcs. Packing
772 06	12'li / 12 Pole 4 mm ²	25
772 07	3'lü / 3 Pole 2,5-6 mm ²	100

Erkek-Dişi Kilitlemeli / Male - Female Lock System

PORSELEN KLEMENSLER / STEATITE TERMINALS



REF	No.	Açıklama / Descriptions	Adet / Pcs. Packing
774 01	No 1	2'li Lüster / 2 Pole 2,5 - 4 mm	150
774 02	No 1	3'lü Lüster / 3 Pole 2,5 - 4 mm	100
774 03	No 2	2'li Lüster / 2 Pole 2,5 - 4 - 6mm	100
774 04	No 2	3'lü Lüster / 3 Pole 2,5 - 4 - 6 mm	50
774 05	No 3	2'li Lüster / 2 Pole 6 - 10 mm	50
774 06	No 3	3'lü Lüster / 3 Pole 6 - 10 mm	50
774 07	No1	1'li Lüster / 1 Pole 2,5 - 4 mm	200
774 08	No 2	1'li Lüster / 1 Pole 2,5 - 6 mm	100
774 09	No 3	1'li Lüster / 1 Pole 4 - 6 mm	50

DAĞITICI ÜNİTELER / DISTRIBUTION UNITS

1 KUTUPLU DAĞITICI ÜNİTE

1 SINGLE POLE DISTRIBUTION UNITS (7x12 mm) 125 A

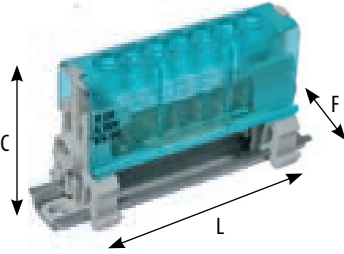

REF	Açıklama / Descriptions	L	C	F	Adet / Pcs. Packing
300 01	2/5 7 Delikli 7 Holes	76	44	42	25
300 02	2/8 10 Delikli 10 Holes	100	44	42	25
300 03	2/10 12 Delikli 12 Holes	115	44	42	25
300 04	2/13 15 Delikli 15 Holes	135	44	42	25
300 05	2/20 22 Delikli 22 Holes	185	44	42	25

2 KUTUPLU DAĞITICI ÜNİTE (7x12 mm) 125 A

2 POLE DISTRIBUTION UNITS (7x12 mm) 125 A

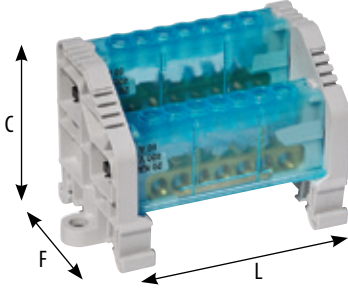

REF	Açıklama / Descriptions	L	C	F	Adet / Pcs. Packing
300 06	2/5 7 Delikli 7 Holes	65	45	47	22
300 07	2/8 10 Delikli 10 Holes	88	45	47	15
300 08	2/10 12 Delikli 12 Holes	102	45	47	14
300 09	2/13 15 Delikli 15 Holes	126	45	47	12
300 10	2/20 22 Delikli 22 Holes	162	45	47	6

4 KUTUPLU DAĞITICI ÜNİTE (7x12 mm) 125 A

4 POLE DISTRIBUTION UNITS (7x12 mm) 125 A

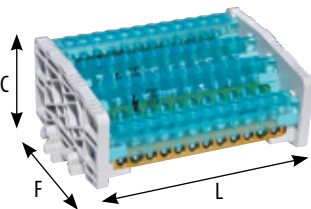

REF	Açıklama / Descriptions	L	C	F	Adet / Pcs. Packing
300 11	2/5 7 delikli 7 Holes	65	45	47	22
300 12	2/8 10 delikli 10 Holes	88	45	47	15
300 13	2/10 12 delikli 12 Holes	102	45	47	14
300 14	2/13 15 delikli 15 Holes	126	45	47	12
300 15	2/20 22 delikli 22 Holes	175	45	47	6

SERTİFİKALAR / CERTIFICATES

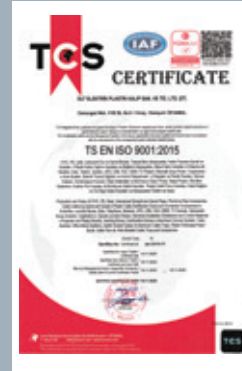
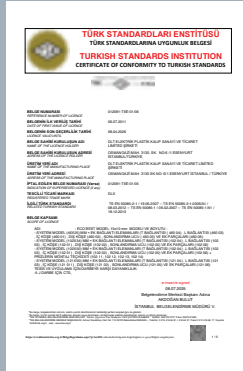

DLX'in yenilikçi ürün sistemleri endüstri tasarım tescil ve faydalı model belgeleri ile koruma altında olup sınai mülkiyet hakkımız saklıdır. İzin alınmadan kopya edilemez.

© Copyright

DLX innovative product systems and industrial design registration are protected under the utility model documents and reserve the right of industrial property. May not be copied without permission.

© Copyright

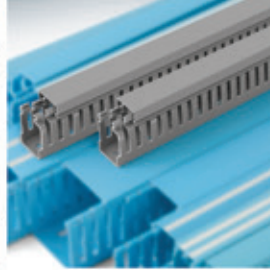
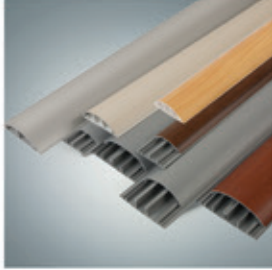
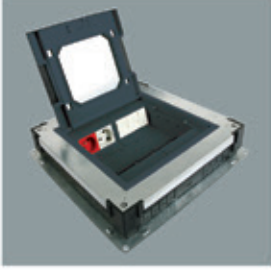

DLX[®]
electric



Trade Name:

**DLT ELEKTRİK PLASTİK
KALIP SAN.VE.TIC.LTD.STİ**

Address: OSMANGAZI MAH. 3130.SOK. NO:6 K:1
KIRAC ESENYURT, ISTANBUL - TURKIYE

Postcode: 34522

E-mail: info@dlx.com.tr

Phone: +90 212 886 4051

+90 212 886 4052

 +90 530 416 85 25



www.dlx.com.tr