

**DLX**<sup>®</sup>  
*electric*

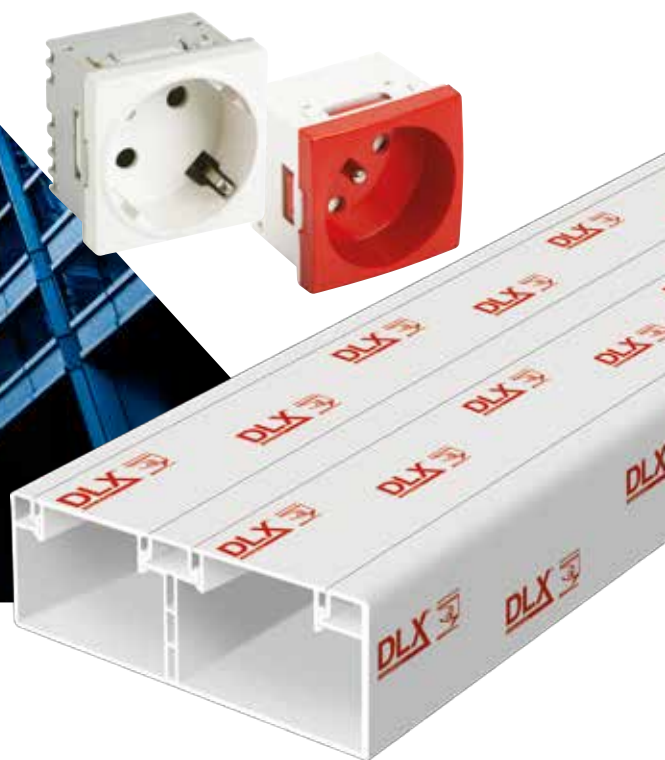

# Catalogue 2024



**09**

Sistem Kablo Kanalları  
Cable Trunkings Systems

**29**

Aluminyum Kablo  
Kanal Sistemleri  
Aluminium Cable  
Trunking Systems

**30**

Eko Best Seri  
Kablo Kanalları  
Eco Best Line  
Cable Trunkings

**33**

Eko Best Seri  
Yapışkanlı Kablo  
Kanalları  
Eco Best Line  
Self Adhesive  
Cable Trunkings

**39**

Canafix Seri  
Kablo Kanalları  
Canafix Line  
Cable Trunkings

**43**

Döşeme Üstü  
Kablo Kanal Sistemleri  
Overfloor Cable  
Trunking System

**45**

DLX Line  
Delikli Pano Kanalları  
DLX Line Slotted  
Cable Trunkings

**51**

Helezon Pano  
Spirali  
Helicoid Panel  
Spiral

**52**

DLXFIL Tel Örgü  
Kanalları  
DLX Wire-Mesh  
Cable Trays

**62**

Şebeke, Ups, Data &  
Telefon Prizleri  
Energy, Ups, Data &  
Telephone Sockets

**69**

Döşeme Altı Çıkış  
Güç Dağıtım Kutuları  
Underfloor Power  
Distribution Boxes

**75**

Dahili 45x45 Modül  
Priz Kutuları/Yapısal  
Kablolama Sistemleri  
45x45 Socket Boxes  
Structural Cabling  
Systems

**77**

Ofis Blok  
Sistemleri  
Block Office  
Systems

**80**

Masa Üstü  
Priz Sistemleri  
Çalışma Ortamı  
Çözümleri  
Desktop Socket Systems  
Work Station Solutions

**86**

PDU Güç Dağıtım  
Sistemleri  
Power Distribution  
Units System

**98**

Elektrik Tesisat  
Boruları  
Electrical Installation  
Conduits

**105**

Elektrik Spiral  
Boruları  
Electrical Installation  
Corrugated Conduits

**115**

DLX Sanayi Ürün Grubu  
DLX Industrial Product  
Group



## ÇEVRE DOSTU ECO FRIENDLY ENVIRONMENT

Çevreye saygılı tasarlanmış ürünler

Designed products that respect to the environment

DLX tüm tüketici ihtiyaçlarına cevap veren kaliteli çevre dostu ürünler sunar... RoHs\* direktifine uyumlu ürünler.

DLX meet the needs of all consumers by offering high quality eco-friendly products in accordance with RoHs \* directive compliant norms.

Geri dönüşümlü, doğada çözülebilen ambalaj kullanımı.

The use of recycled, biodegradable packaging.

%100 geri dönüşümlü M1 sınıfı orjinal PVC hammadde kullanımı.

100% recycled original M1 class PVC raw material usage.

DLX üretim tesisi ISO 9001 -2008 kalite sertifikası belgelidir.

DLX manufacturing plant is certified by ISO 9001 -2008 quality standards.

\* "Restriction of Hazardous Substances Directive" (Belirli zararlı maddelerin "ağır metaller" kullanımını kısıtlama) kelimelerinin baş harflerinden oluşur (RoHs)



**Y**ENİLİKÇİ ÜRÜN SİSTEMLERİ  
INNOVATIVE PRODUCT SYSTEMS



AVM'ler

Shopping Malls



Fabrika'lar

Factories



Ofisler

Offices



Kamu Kurumları

Public and Government  
Institutions



Eğitim Kurumları

Educational Institutions



Sağlık Kurumları

Medical Institutions



**T**EKNIK ÖZELLİKLER  
TECHNICAL DETAILS



Kimyasal ve Asit buharına dayanımı  
**Resistance to chemical and acid steam**



Mekanik darbelere dayanıklı.  
**Resistance to mechanical shock hits 2 Joule**



Alev aldığı anda kendiliğinden sönebilen katkı maddeli PVC malzeme (UL94V0 M1).  
**Self extinguishing PVC fire reaction (UL94V0 M1)**



Ultraviyole ışıklara dayanıklı (UV).  
**Resistance to ultraviolet lights (UV).**



Boyanabilir.  
**Paintable**



Kablo kanalları kurflunsuz hammaddeden üretilmektedir.  
**Use of unleaded raw materials on cable trunkings**



Topraklama gerektirmez  
**No need for grounding**



İstenilen boyutta kesilebilir.  
**Cut down to required size**

Özel bir alet gerektirmeden montaj yapılır.  
46-121mm en, 18-50mm derinlik arasında 7 değişik kanal.  
Kanal bağlantı aksesuarları.  
Data ve enerji prizleri takılabilir.  
Ultraviyole ışıklara dayanıklı (UV).  
Koruma sınıfı IP 40.  
Dielektrik dayanımı 270kw/cm değerindedir.  
Kablo kanalları beyaz RAL 9010-9016'dır.  
Karton kutu ambalaja sahiptir.  
Tabanı 46mm üzerinde olan tüm kanallar tam radiuslüdür.  
Döfleme üstü kablo kanalları tam kapaklıdır.

Assembly is done without special tools.  
Trunking measuring from 46 to 121mm wide, from 18 to 50mm depth.  
Full range of fitting and assembling accessories.  
All data, power and sockets can be easily installed.  
Resistant to ultraviolet lights (UV).  
Protection class IP 40.  
Dielectric strength level is 270kw/cm.  
Colours of trunking: White RAL 9010-9016.  
Packaging with carton paper box.  
Cable trunking with more than 46mm base line, have full radius.  
Overfloor cable trunkings have full cover.







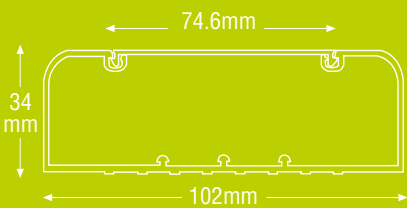
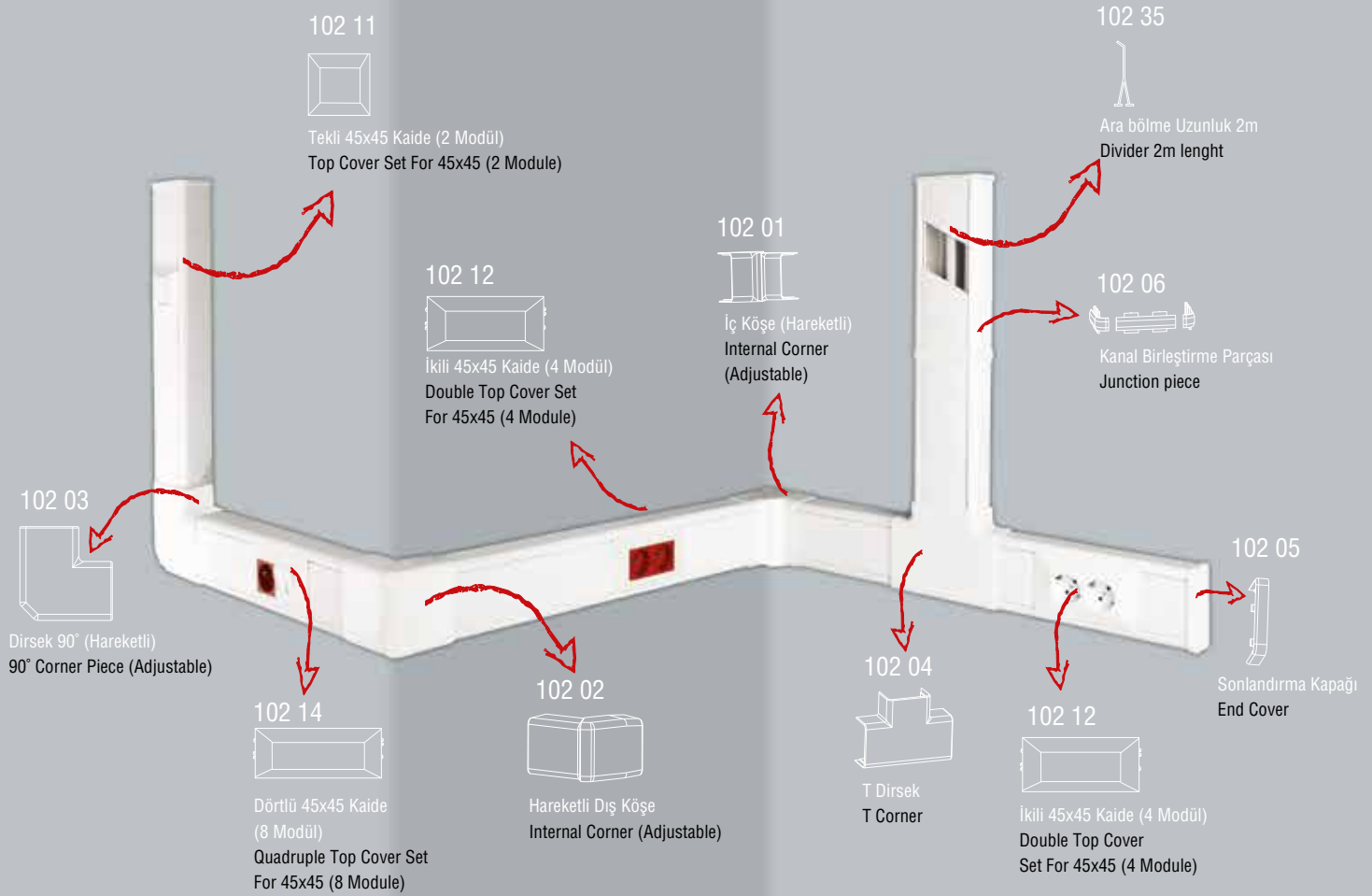

**K**ABLO KANAL SİSTEMLERİ  
CABLE TRUNKING SYSTEMS

Ref:102 34  
**102 x 34**

Ambalaj: 24m  
Uzunluk 2m Kesit: 102x34  
Kapaklı satılır. 3 ara bölme takılabilir.  
Renk RAL 9010-9016 Beyaz

Packaging Unit: 24m  
2m length, Dimension: 102x34  
Complete with cover. Up to 3 divider possibility  
Color RAL 9010-9016 White

## MONTAJ TAMAMLAMA AKSESUARLARI / CABLE TRUNKING ACCESSORY LINE



102 35

Ambalaj: 80m  
Ara bölme Uzunluk 2m  
Packaging: 80m  
Divider 2m length



102 01

Ambalaj: 10 Adet  
İç Köşe (Hareketli)  
Packaging: 10 pcs  
Internal Corner (Adjustable)



102 02

Ambalaj: 6 Adet  
Dış Köşe (Hareketli)  
Packaging: 6 pcs  
External Corner (Adjustable)



102 03

Ambalaj: 6 Adet  
Dirsek 90° (Hareketli)  
Packaging: 6 pcs  
90° Corner Piece (Adjustable)

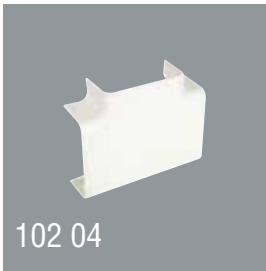

102 04

Ambalaj: 8 Adet  
T Dirsek  
Packaging: 8 pcs  
T Corner



102 05

Ambalaj: 20 Adet  
Sonlandırma Kapağı  
Packaging: 20 pcs  
End Cover



102 06

Ambalaj: 20 Adet  
Kanal Birleştirme Parçası  
Packaging: 20 pcs  
Junction piece



102 07

Ambalaj: 20 Adet  
Kablo Tutucu  
Packaging: 20 pcs  
Cable Holder

## ANAHTAR PRİZ MONTAJ AKSESUARLARI / SWITCH SOCKET NETWORK ASSEMBLY SET



102 15

Ambalaj: 5 Adet  
İngiliz Tipi Tekli Priz Çerçevesi  
Packaging: 5 pcs  
British Type Socket Frame

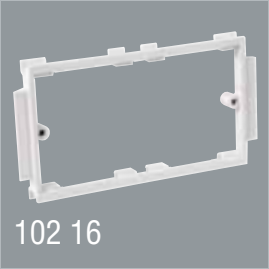

102 16

Ambalaj: 15 Adet  
İngiliz Tipi İkili Priz Çerçevesi  
Packaging: 15 pcs  
British Type Double Socket Frame



102 11

Ambalaj: 8 Adet  
Tekli 45x45 Kaide (2 Modül)  
Packaging: 8 pcs  
Top Cover Set For 45x45  
(2 Module)



102 12

Ambalaj: 15 Adet  
İkili 45x45 Kaide (4 Modül)  
Packaging: 15 pcs  
Double Top Cover Set For  
45x45 (4 Module)



102 13

Ambalaj: 15 Adet  
Üçlü 45x45 Kaide (6 Modül)  
Packaging: 15 pcs  
Triple Top Cover Set For  
45x45 (6 Module)



102 14

Ambalaj: 10 Adet  
Dörtlü 45x45 Kaide (8 Modül)  
Packaging: 10 pcs  
Quadruple Top Cover Set For  
45x45 (8 Module)

Ref:102 50  
**102 x 50**

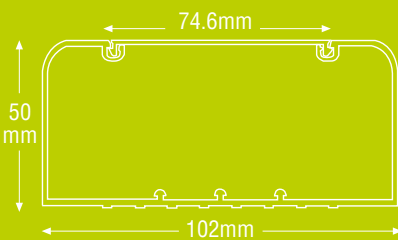
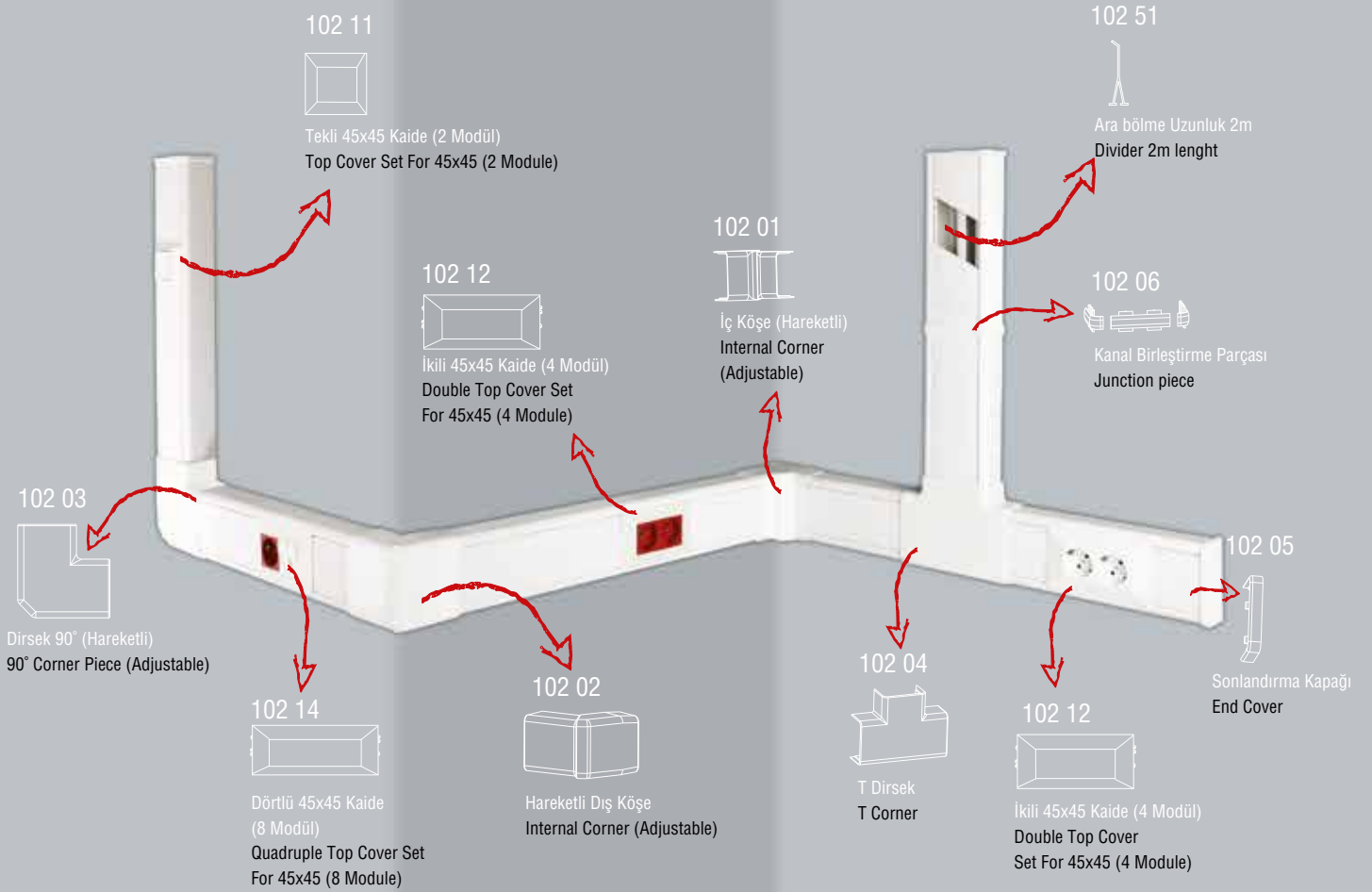

Ambalaj: 16m  
Uzunluk 2m Kesit: 102x50  
Kapaklı satılır. 3 ara bölme takılabilir.  
Renk RAL 9010-9016 Beyaz

Packaging Unit: 16m  
2m length, Dimensions: 102x50  
Complete with cover. Up to 3 divider possibility  
Color RAL 9010-9016 White



102 09  
Ambalaj: 10 Adet  
Kanal İçi Klemens Buatı (Küp)  
Packaging: 10 pcs  
Terminal Connection Box

## MONTAJ TAMAMLAMA AKSESUARLARI / CABLE TRUNKING ACCESSORY LINE



102 51

Ambalaj: 50m  
Ara bölme Uzunluk 2m  
Packaging:50m  
Divider 2m lenght



102 01

Ambalaj: 10 Adet  
İç Köşe (Hareketli)  
Packaging:10 pcs  
Internal Corner (Adjustable)



102 02

Ambalaj: 6 Adet  
Dış Köşe (Hareketli)  
Packaging:6 pcs  
External Corner (Adjustable)



102 03

Ambalaj: 6 Adet  
Dirsek 90° (Hareketli)  
Packaging:6 pcs  
90° Corner Piece (Adjustable)



102 04

Ambalaj: 8 Adet  
T Dirsek  
Packaging:8 pcs  
T Corner



102 05

Ambalaj: 20 Adet  
Sonlandırma Kapağı  
Packaging: 20 pcs  
End Cover



102 06

Ambalaj: 20 Adet  
Kanal Birleştirme Parçası  
Packaging:20 pcs  
Junction piece



102 07

Ambalaj: 20 Adet  
Kablo Tutucu  
Packaging:20 pcs  
Cable Holder

## ANAHTAR PRİZ MONTAJ AKSESUARLARI / SWITCH SOCKET NETWORK ASSEMBLY SET



102 15

Ambalaj: 5 Adet  
İngiliz Tipi Tekli Priz Çerçevesi  
Packaging:5 pcs  
British Type Socket Frame

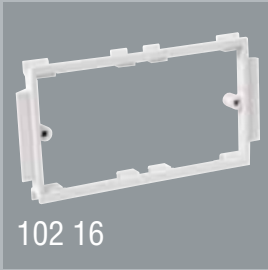

102 16

Ambalaj: 15 Adet  
İngiliz Tipi İkili Priz Çerçevesi  
Packaging:15 pcs  
British Type Double Socket Frame



102 11

Ambalaj: 8 Adet  
Tekli 45x45 Kaide (2 Modül)  
Packaging: 8 pcs  
Top Cover Set For 45x45  
(2 Module)



102 12

Ambalaj: 15 Adet  
İkili 45x45 Kaide (4 Modül)  
Packaging:15 pcs  
Double Top Cover Set For  
45x45 (4 Module)



102 13

Ambalaj: 15 Adet  
Üçlü 45x45 Kaide (6 Modül)  
Packaging:15 pcs  
Triple Top Cover Set For  
45x45 (6 Module)



102 14

Ambalaj: 10 Adet  
Dörtlü 45x45 Kaide (8 Modül)  
Packaging:10 pcs  
Quadruple Top Cover Set For  
45x45 (8 Module)

Ref:102 50 EC  
102 x 50

**DLX**  
electric  
**basic**

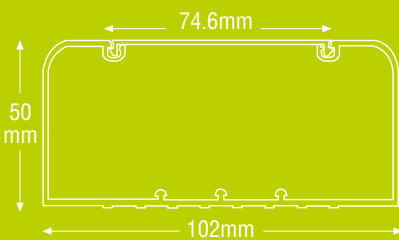
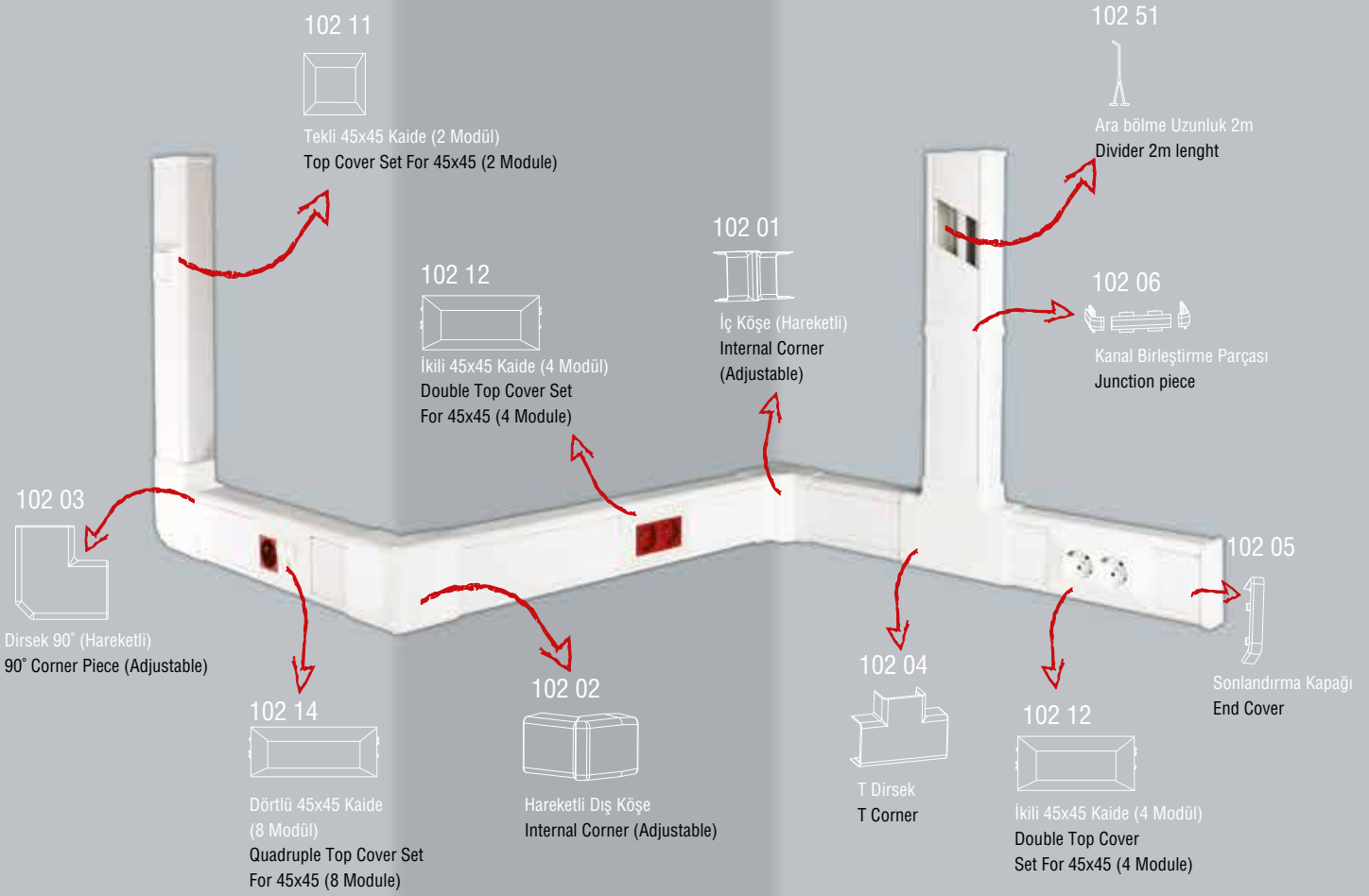

Ambalaj: 16m  
Uzunluk 2m Kesit: 102x50  
Kapaklı satılır. 3 ara bölme takılabilir.  
Renk RAL 9010-9016 Beyaz

Packaging Unit: 16m  
2m length, Dimensions: 102x50  
Complete with cover. Up to 3 divider possibility  
Color RAL 9010-9016 White



102 09

Ambalaj: 10 Adet  
Kanal İçi Klemens Buatı (Küp)  
Packaging: 10 pcs  
Terminal Connection Box

## MONTAJ TAMAMLAMA AKSESUARLARI / CABLE TRUNKING ACCESSORY LINE



102 51

Ambalaj: 50m  
Ara bölme Uzunluk 2m  
Packaging:50m  
Divider 2m lenght



102 01

Ambalaj: 10 Adet  
İç Köşe (Hareketli)  
Packaging:10 pcs  
Internal Corner (Adjustable)



102 02

Ambalaj: 6 Adet  
Dış Köşe (Hareketli)  
Packaging:6 pcs  
External Corner (Adjustable)



102 03

Ambalaj: 6 Adet  
Dirsek 90° (Hareketli)  
Packaging:6 pcs  
90° Corner Piece (Adjustable)



102 04

Ambalaj: 8 Adet  
T Dirsek  
Packaging:8 pcs  
T Corner



102 05

Ambalaj: 20 Adet  
Sonlandırma Kapağı  
Packaging: 20 pcs  
End Cover



102 06

Ambalaj: 20 Adet  
Kanal Birleştirme Parçası  
Packaging:20 pcs  
Junction piece



102 07

Ambalaj: 20 Adet  
Kablo Tutucu  
Packaging:20 pcs  
Cable Holder

## ANAHTAR PRİZ MONTAJ AKSESUARLARI / SWITCH SOCKET NETWORK ASSEMBLY SET



102 15

Ambalaj: 5 Adet  
İngiliz Tipi Tekli Priz Çerçevesi  
Packaging:5 pcs  
British Type Socket Frame

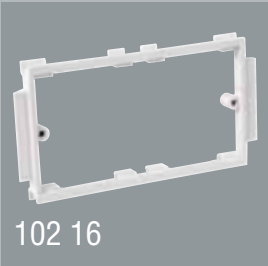

102 16

Ambalaj: 15 Adet  
İngiliz Tipi İkili Priz Çerçevesi  
Packaging:15 pcs  
British Type Double Socket Frame



102 11

Ambalaj: 8 Adet  
Tekli 45x45 Kaide (2 Modül)  
Packaging: 8 pcs  
Top Cover Set For 45x45  
(2 Module)



102 12

Ambalaj: 15 Adet  
İkili 45x45 Kaide (4 Modül)  
Packaging:15 pcs  
Double Top Cover Set For  
45x45 (4 Module)



102 13

Ambalaj: 15 Adet  
Üçlü 45x45 Kaide (6 Modül)  
Packaging:15 pcs  
Triple Top Cover Set For  
45x45 (6 Module)



102 14

Ambalaj: 10 Adet  
Dörtlü 45x45 Kaide (8 Modül)  
Packaging:10 pcs  
Quadruple Top Cover Set For  
45x45 (8 Module)

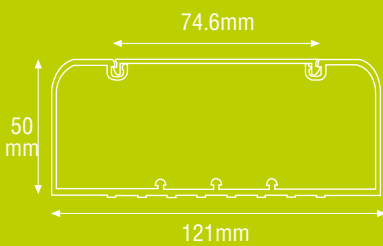
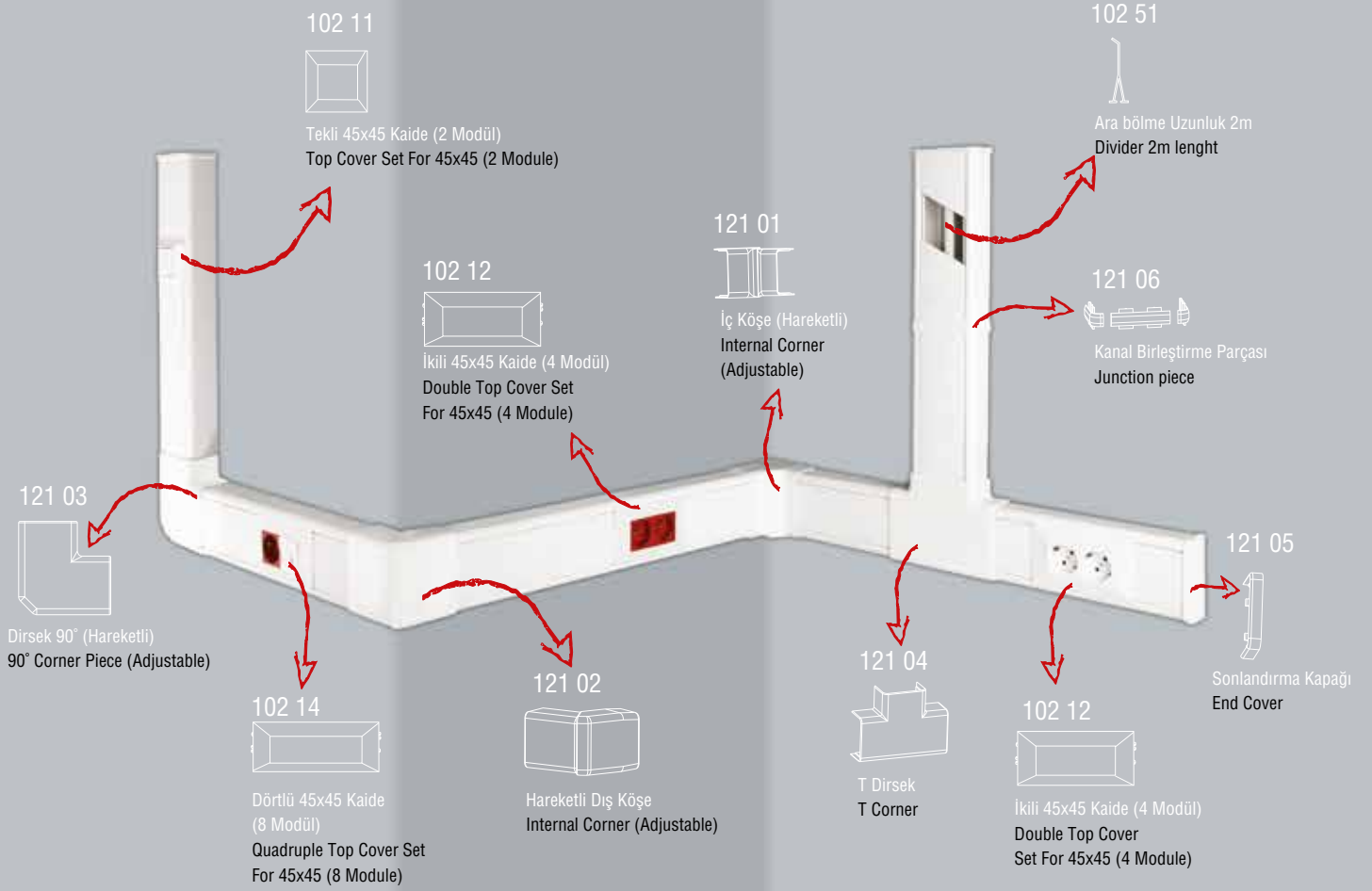
Ref:121 50  
**121 x 50**

Ambalaj: 16m  
Uzunluk 2m Kesit: 121x50  
Kapaklı satılır. 3 ara bölme takılabilir.  
Renk RAL 9010-9016 Beyaz

Packaging Unit: 16m  
2m length, Dimensions: 121x50  
Complete with cover. Up to 3 divider possibility  
Color RAL 9010-9016 White



**102 09**  
Ambalaj: 10 Adet  
Kanal İçi Klemens Buatı (Küp)  
Packaging: 10 pcs  
Terminal Connection Box



## MONTAJ TAMAMLAMA AKSESUARLARI / CABLE TRUNKING ACCESSORY LINE



102 51

Ambalaj: 50m  
Ara bölme Uzunluk 2m  
Packaging: 50m  
Divider 2m length



121 01

Ambalaj: 4 Adet  
İç Köşe (Hareketli)  
Packaging: 4 pcs  
Internal Corner (Adjustable)



121 02

Ambalaj: 4 Adet  
Dış Köşe (Hareketli)  
Packaging: 4 pcs  
External Corner (Adjustable)



121 03

Ambalaj: 4 Adet  
Dirsek 90° (Hareketli)  
Packaging: 4 pcs  
90° Corner Piece (Adjustable)



121 04

Ambalaj: 4 Adet  
T Dirsek  
Packaging: 4 pcs  
T Branches



121 05

Ambalaj: 15 Adet  
Sonlandırma Kapağı  
Packaging: 15 pcs  
End Cover



121 06

Ambalaj: 10 Adet  
Kanal Birleştirme Parçası  
Packaging: 10 pcs  
Junction piece



102 07

Ambalaj: 10 Adet  
Kablo Tutucu  
Packaging: 10 pcs  
Cable Holder

## ANAHTAR PRİZ MONTAJ AKSESUARLARI / SWITCH SOCKET NETWORK ASSEMBLY SET



102 15

Ambalaj: 5 Adet  
İngiliz Tipi Tekli Priz Çerçevesi  
Packaging: 5 pcs  
British Type Socket Frame

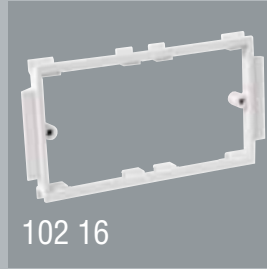

102 16

Ambalaj: 15 Adet  
İngiliz Tipi İkili Priz Çerçevesi  
Packaging: 15 pcs  
British Type Double Socket Frame



102 11

Ambalaj: 8 Adet  
Tekli 45x45 Kaide (2 Modül)  
Packaging: 8 pcs  
Top Cover Set For 45x45  
(2 Module)



102 12

Ambalaj: 15 Adet  
İkili 45x45 Kaide (4 Modül)  
Packaging: 15 pcs  
Double Top Cover Set For  
45x45 (4 Module)



102 13

Ambalaj: 15 Adet  
Üçlü 45x45 Kaide (6 Modül)  
Packaging: 15 pcs  
Triple Top Cover Set For  
45x45 (6 Module)



102 14

Ambalaj: 10 Adet  
Dörtlü 45x45 Kaide (8 Modül)  
Packaging: 10 pcs  
Quadruple Top Cover Set For  
45x45 (8 Module)

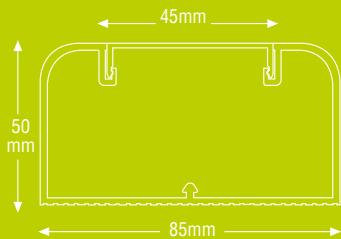
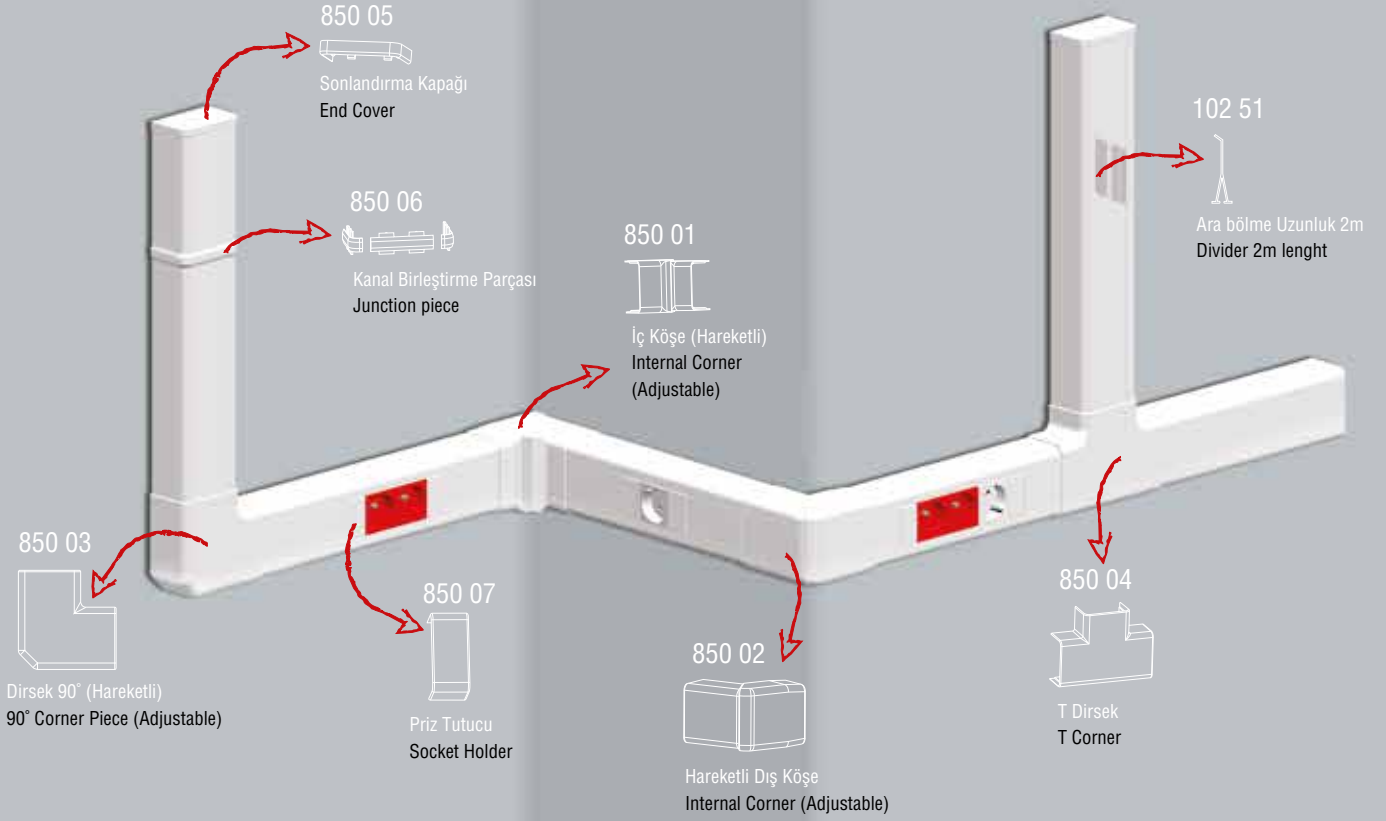
Ref:85 050  
**85 x 50****ET KALINLIĞI 2 mm**  
**THICKNESS 2 mm**

Ambalaj: 16m  
Uzunluk 2m Kesit: 85x50  
Kapaklı satılır.  
Renk RAL 9010-9016 Beyaz

Packaging Unit: 16m  
2m length, Dimensions: 85x50  
Complete with cover.  
Color RAL 9010-9016 White

Kanal üzerine çerçevesiz direk priz montajı  
Frameless socket assembling on cable trunking (Direct socket assembling)

**MONTAJ TAMAMLAMA AKSESUARLARI / CABLE TRUNKING ACCESSORY LINE**

102 51

Ambalaj: 50m  
Ara bölme Uzunluk 2m  
Packaging:50m  
Divider 2m lenght

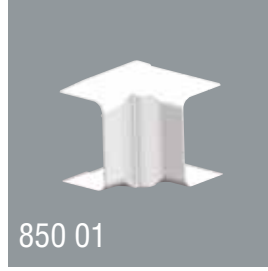

850 01

Ambalaj: 5 Adet  
İç Köşe  
Packaging:5 pcs  
Internal Corner



850 02

Ambalaj: 5 Adet  
Dış Köşe  
Packaging:5 pcs  
External Corner



850 03

Ambalaj: 5 Adet  
Dirsek 90° (Hareketli)  
Packaging:5 pcs  
90° Corner Piece (Adjustable)

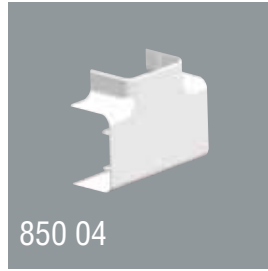

850 04

Ambalaj: 5 Adet  
T Dirsek  
Packaging:5 pcs  
T Corner



850 05

Ambalaj: 10 Adet  
Sonlandırma Kapağı  
Packaging:10 pcs  
End Cover



850 07

Ambalaj: 10 Adet  
Priz Tutucu  
Packaging:10 pcs  
Socket Holder



Ref:130 50  
130 x 50

**DLX**  
electric  
**prime**

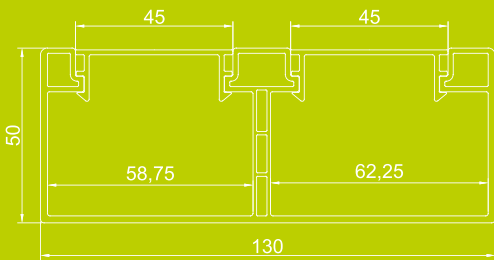
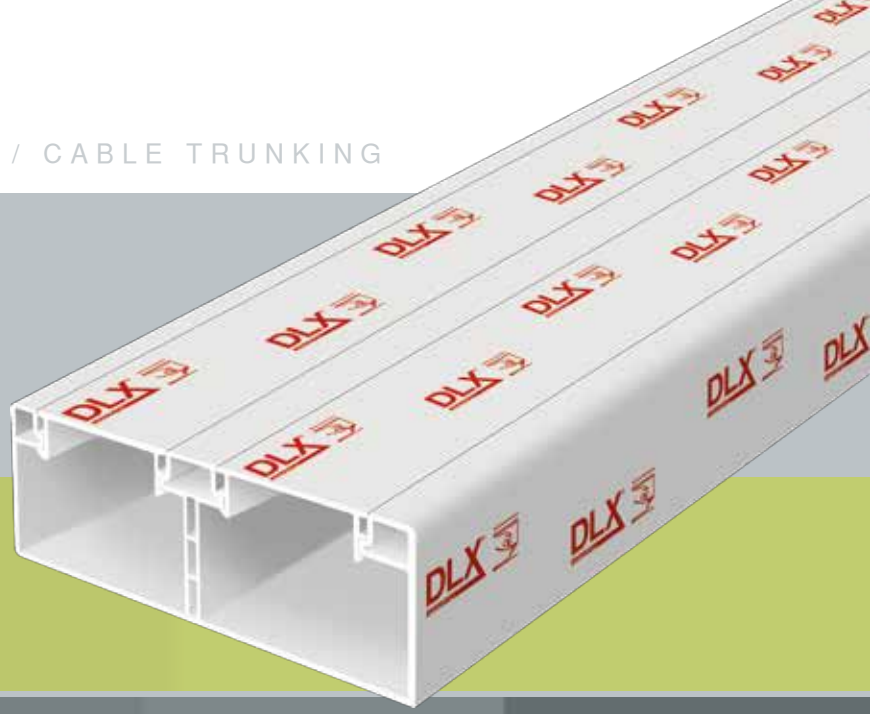

#### Çift Kompartmanlı Kanal

Ambalaj: 12m  
Uzunluk 2m Kesit: 130x50  
2 Adet Kapaklı satılır.  
Renk RAL 9010-9016 Beyaz

#### Two Compartment Trunk

Packaging Unit: 12m  
2m length, Dimensions: 130x50  
2 Pieces Complete with cover.  
Color RAL 9010-9016 White

Kanal üzerine çerçevesiz direk priz montajı  
Frameless socket assembling on cable trunking (Direct socket assembling)

## MONTAJ TAMAMLAMA AKSESUARLARI / CABLE TRUNKING ACCESSORY LINE



130 01

Ambalaj: 5 Adet  
İç Köşe  
Packaging:5 pcs  
Internal Corner



130 02

Ambalaj: 5 Adet  
Dış Köşe  
Packaging:5 pcs  
External Corner



130 03

Ambalaj: 5 Adet  
Dirsek 90° (Hareketli)  
Packaging:5 pcs  
90° Corner Piece (Adjustable)



130 04

Ambalaj: 5 Adet  
T Dirsek  
Packaging:5 pcs  
T Corner



130 05

Ambalaj: 10 Adet  
Sonlandırma Kapağı  
Packaging:10 pcs  
End Cover



850 07

Ambalaj: 10 Adet  
Priz Tutucu  
Packaging:10 pcs  
Socket Holder

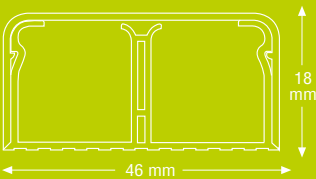
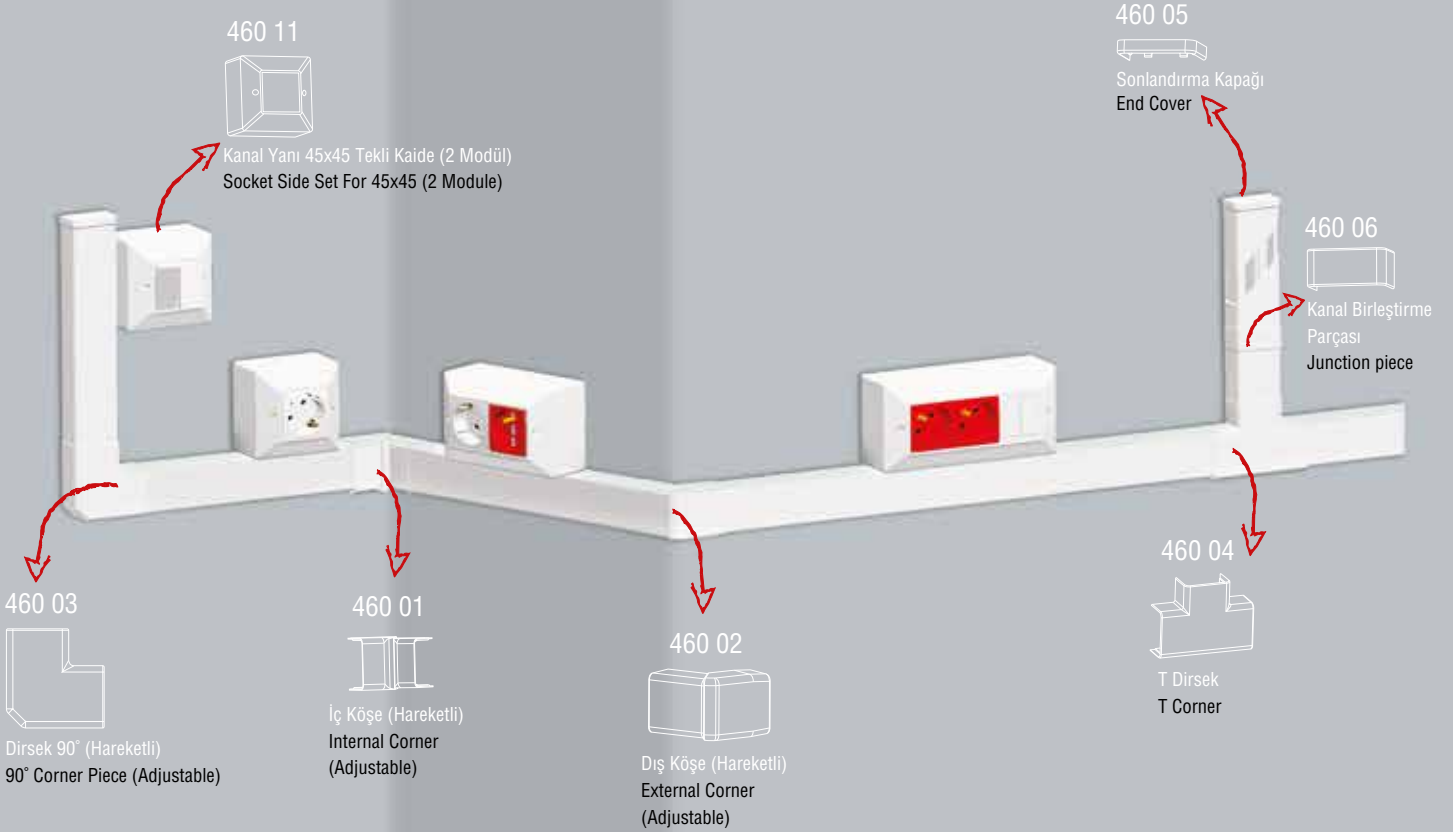
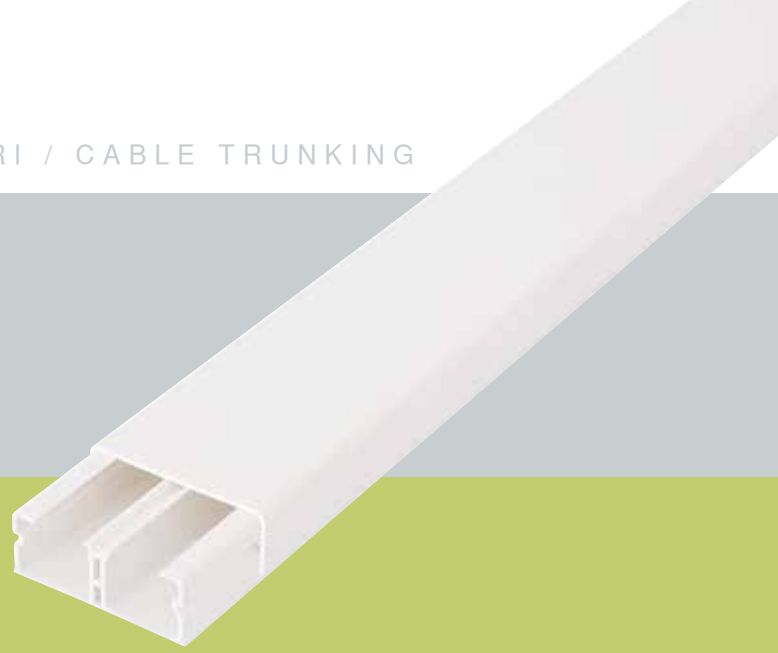

Ref:460 18  
46 x 18

Ambalaj: 60m  
Uzunluk 2m Kesit: 46x18  
Kapaklı satılır. Kendinden bölmelidir.  
Renk RAL 9010-9016 Beyaz

Packaging Unit: 60m  
2m length, Dimensions: 46x18  
Complete with cover. Produced with the separator part.  
Color RAL 9010-9016 White

**MONTAJ TAMAMLAMA AKSESUARLARI / CABLE TRUNKING ACCESSORY LINE**

460 01

Ambalaj: 6 Adet  
İç Köşe (Hareketli)  
Packaging:6 pcs  
Internal Corner (Adjustable)



460 02

Ambalaj: 6 Adet  
Dış Köşe (Hareketli)  
Packaging:6 pcs  
External Corner (Adjustable)



460 03

Ambalaj: 6 Adet  
Dirsek 90° (Hareketli)  
Packaging:6 pcs  
90° Corner Piece (Adjustable)

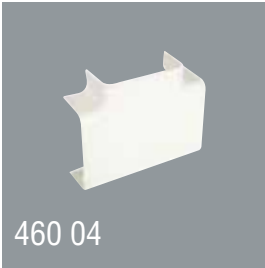

460 04

Ambalaj: 6 Adet  
T Dirsek  
Packaging:6 pcs  
T Corner



460 05

Ambalaj: 50 Adet  
Sonlandırma Kapağı  
Packaging:50 pcs  
End Cover



460 06

Ambalaj: 50 Adet  
Kanal Birleştirme Parçası  
Packaging:50 pcs  
Junction piece

**ANAHTAR PRİZ MONTAJ AKSESUARLARI / SWITCH SOCKET NETWORK ASSEMBLY SET**

460 11

Ambalaj: 10 Adet  
Kanal Yanı 45x45 Tekli Kaide  
(2 Modül)  
Packaging:10 pcs  
Socket Side Set For 45x45  
(2 Module)



460 15

Ambalaj: 15 Adet  
Sıvaüstü tekli kasa (universal tip)  
Packaging:15 pcs  
Surface-mounted single box (universal type)

Uygulama / Application

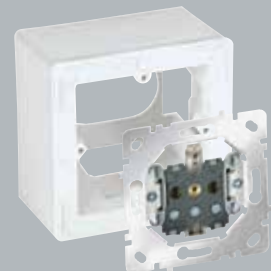

Ref:461 18  
**46 x 18**  
Bölmesiz  
(Without Seperator)

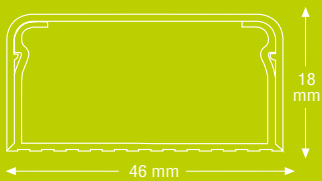
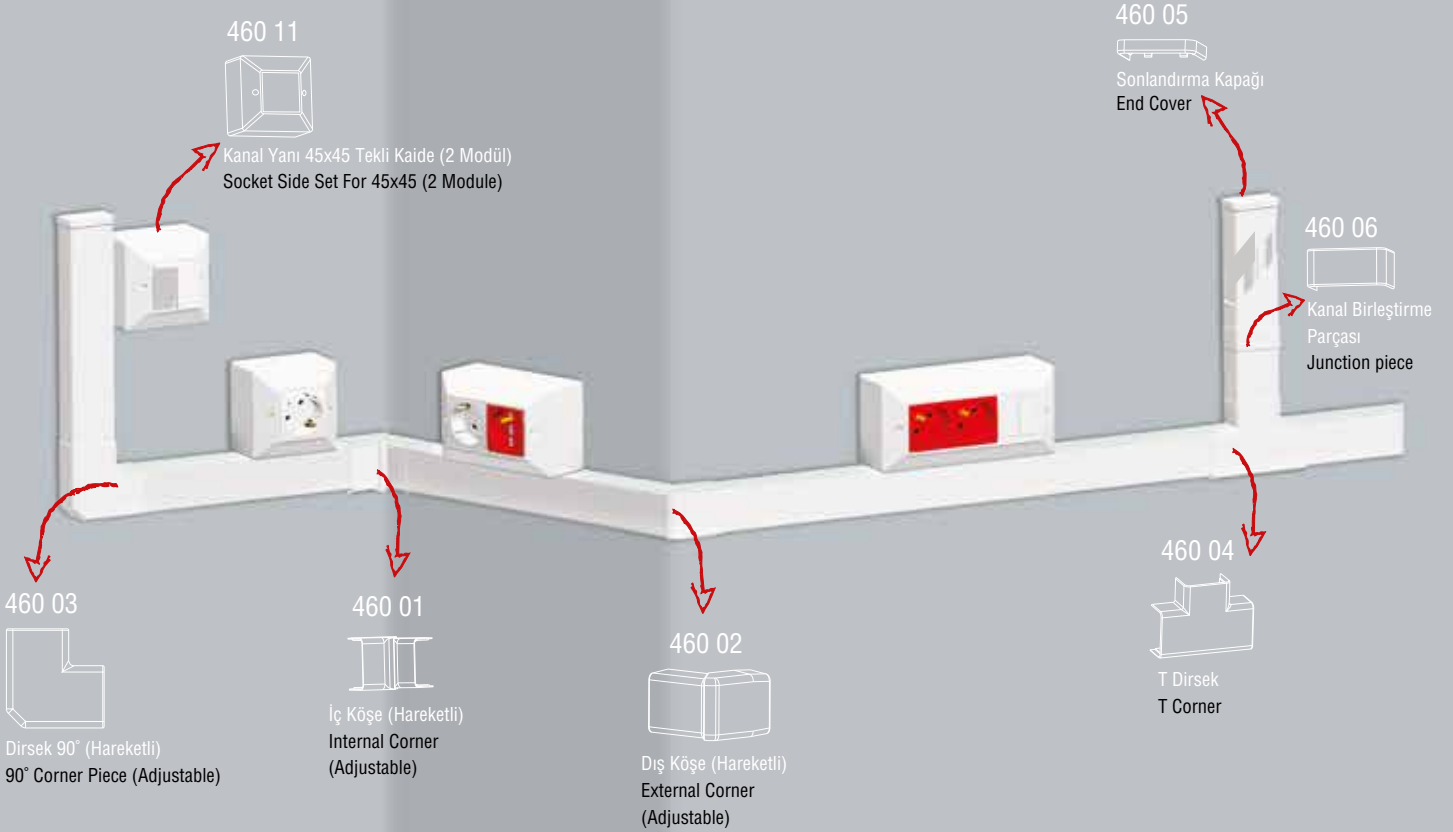

Ambalaj: 60m  
Uzunluk 2m Kesit: 46x18  
Kapaklı satılır.  
Renk RAL 9010-9016 Beyaz

Packaging Unit: 60m  
2m length, Dimensions: 46x18  
Complete with cover.  
Color RAL 9010-9016 White



**MONTAJ TAMAMLAMA AKSESUARLARI / CABLE TRUNKING ACCESSORY LINE**

460 01

Ambalaj: 6 Adet  
İç Köşe (Hareketli)  
Packaging: 6 pcs  
Internal Corner (Adjustable)



460 02

Ambalaj: 6 Adet  
Dış Köşe (Hareketli)  
Packaging: 6 pcs  
External Corner (Adjustable)



460 03

Ambalaj: 6 Adet  
Dirsek 90° (Hareketli)  
Packaging: 6 pcs  
90° Corner Piece (Adjustable)

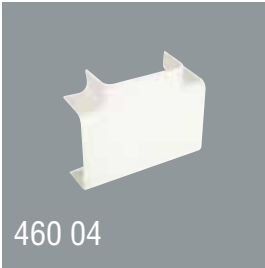

460 04

Ambalaj: 6 Adet  
T Dirsek  
Packaging: 6 pcs  
T Corner



460 05

Ambalaj: 50 Adet  
Sonlandırma Kapağı  
Packaging: 50 pcs  
End Cover



460 06

Ambalaj: 50 Adet  
Kanal Birleştirme Parçası  
Packaging: 50 pcs  
Junction piece

**ANAHTAR PRİZ MONTAJ AKSESUARLARI / SWITCH SOCKET NETWORK ASSEMBLY SET**

460 11

Ambalaj: 10 Adet  
Kanal Yanı 45x45 Tekli Kaide  
(2 Modül)  
Packaging: 10 pcs  
Socket Side Set For 45x45 (2 Module)



460 15

Ambalaj: 10 Adet  
Sıvaüstü tekli kasa (universal tip)  
Packaging: 10 pcs  
Surface-mounted single box (universal type)

Uygulama / Application

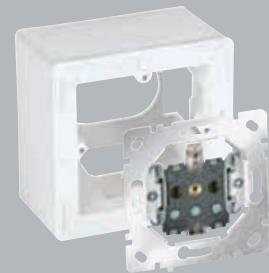

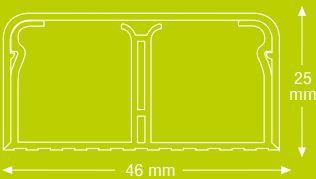
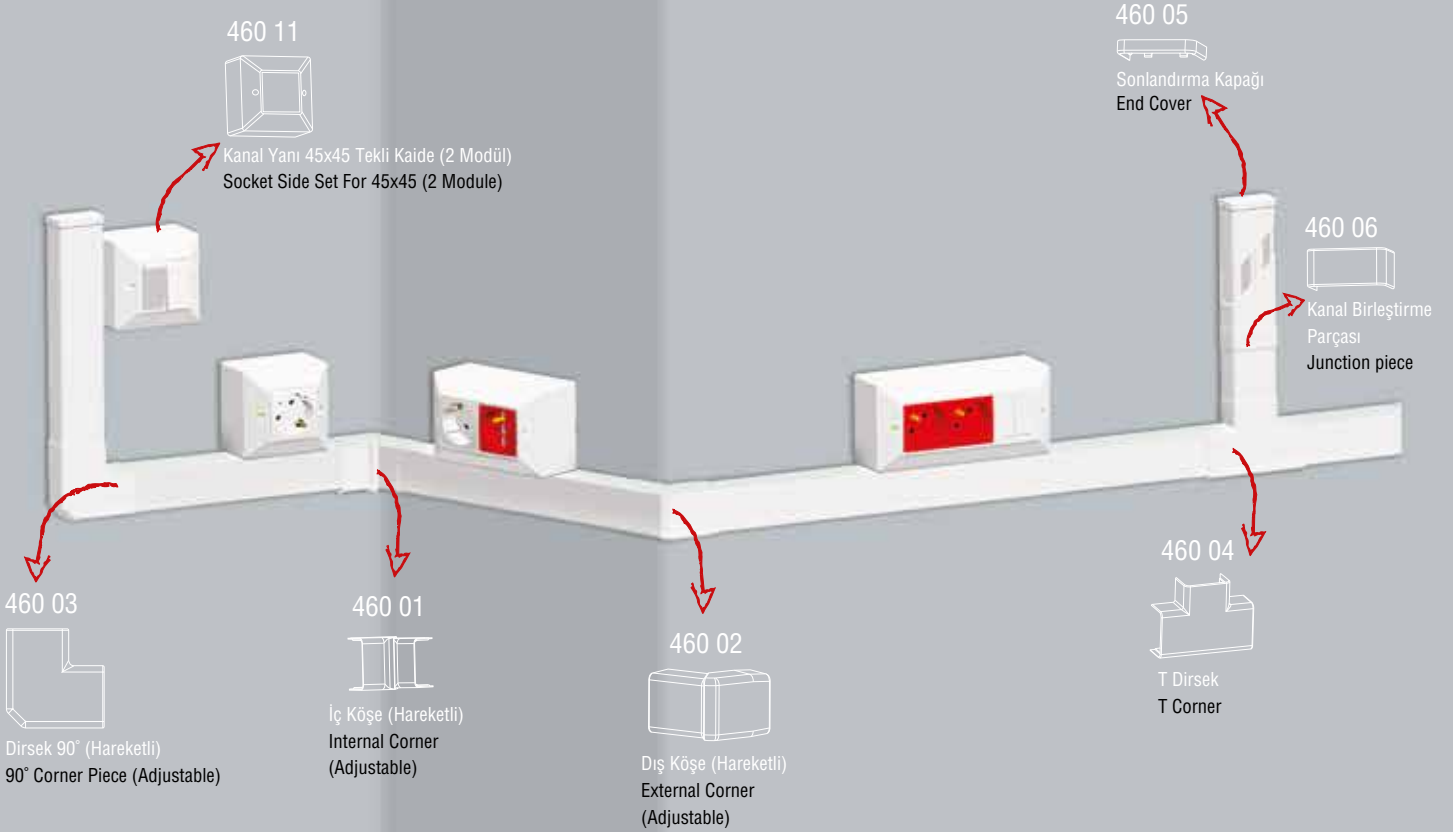
Ref:460 25  
46 x 25

Ambalaj: 50m  
Uzunluk 2m Kesit: 46x25  
Kapaklı satılır. Kendinden bölmelidir.  
Renk RAL 9010-9016 Beyaz

Packaging Unit: 50m  
2m length, Dimensions: 46x25  
Complete with cover. Produced with the separator part.  
Color RAL 9010-9016 White

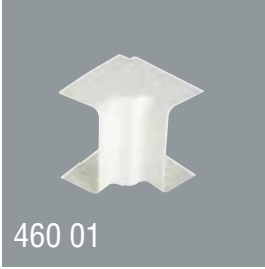
**MONTAJ TAMAMLAMA AKSESUARLARI / CABLE TRUNKING ACCESSORY LINE**

460 01

Ambalaj: 6 Adet  
İç Köşe (Hareketli)  
Packaging: 6 pcs  
Internal Corner (Adjustable)



460 02

Ambalaj: 6 Adet  
Dış Köşe (Hareketli)  
Packaging: 6 pcs  
External Corner (Adjustable)



460 03

Ambalaj: 6 Adet  
Dirsek 90° (Hareketli)  
Packaging: 6 pcs  
90° Corner Piece (Adjustable)

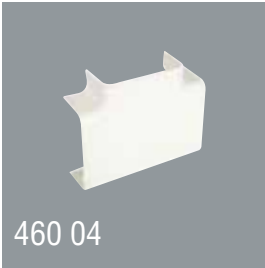

460 04

Ambalaj: 6 Adet  
T Dirsek  
Packaging: 6 pcs  
T Corner



460 05

Ambalaj: 50 Adet  
Sonlandırma Kapağı  
Packaging: 50 pcs  
End Cover



460 06

Ambalaj: 50 Adet  
Kanal Birleştirme Parçası  
Packaging: 50 pcs  
Junction piece

**ANAHTAR PRİZ MONTAJ AKSESUARLARI / SWITCH SOCKET NETWORK ASSEMBLY SET**

460 11

Ambalaj: 10 Adet  
Kanal Yanı 45x45 Tekli Kaide  
(2 Modül)  
Packaging: 10 pcs  
Socket Side Set For 45x45 (2 Module)



460 15

Ambalaj: 10 Adet  
Sıvaüstü tekli kasa (universal tip)  
Packaging: 10 pcs  
Surface-mounted single box (universal type)

Uygulama / Application

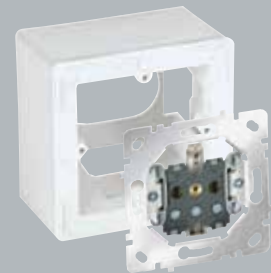

METALİK GRİ BOYALI KABLO KANAL SİSTEMLERİ/METTALIC GREY PAINTING CABLE TRUNKING SYSTEMS



103 50

Ambalaj: 16 m  
102x50 Alüminyum Kablo Kanalı  
Packaging:16 m  
Aluminium Cable Trunking



103 01

Ambalaj: 10 Adet  
İç Köşe (Hareketli)  
Packaging:10 pcs  
Internal Corner (Adjustable)



103 02

Ambalaj: 6 Adet  
Dış Köşe (Hareketli)  
Packaging:6 pcs  
External Corner (Adjustable)



103 03

Ambalaj: 6 Adet  
Dirsek 90° (Hareketli)  
Packaging:6 pcs  
90° Corner Piece (Adjustable)



103 04

Ambalaj: 8 Adet  
T Dirsek  
Packaging:8 pcs  
T Corner

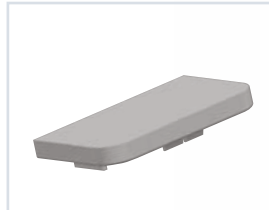

103 05

Ambalaj: 20 Adet  
Sonlandırma Kapağı  
Packaging: 20 pcs  
End Cover



103 06

Ambalaj: 20 Adet  
Kanal Birleştirme Parçası  
Packaging:20 pcs  
Junction piece



102 51

Ambalaj: 50m  
Ara bölme Uzunluk 2m  
Packaging:50m  
Divider 2m length



103 07

Ambalaj: 20 Adet  
Kablo Tutucu  
Packaging:20 pcs  
Cable Holder



Huş  
Birch

Meşe  
Oak

Ceviz  
Walnut

Kanalları istediğiniz renk seçeneklerinde boyanabilir.  
Can be painted with the color you choose

ANAHTAR PRİZ MONTAJ AKSESUARLARI / SWITCH SOCKET NETWORK ASSEMBLY SET

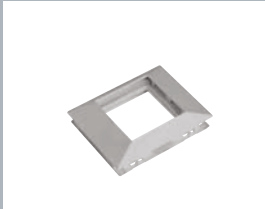

103 11

Ambalaj: 8 Adet  
Tekli 45x45 Kaide (2 Modül)  
Packaging:8 pcs  
Top Cover Set For 45x45  
(2 Module)



103 12

Ambalaj: 15 Adet  
İkili 45x45 Kaide (4 Modül)  
Packaging:15 pcs  
Double Top Cover Set For  
45x45 (4 Module)

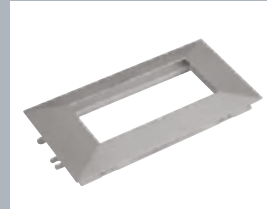

103 13

Ambalaj: 15 Adet  
Üçlü 45x45 Kaide (6 Modül)  
Packaging:15 pcs  
Triple Top Cover Set For  
45x45 (6 Module)

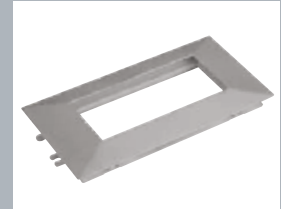

103 14

Ambalaj: 10 Adet  
Dörtlü 45x45 Kaide (8 Modül)  
Packaging:10 pcs  
Quadruple Top Cover Set For  
45x45 (8 Module)

Not: Aksesuarlar metalik boyalı ABS'dir  
Note: Accessories are made of colored ABS Plastic raw material.

# ALUMINYUM KABLO KANAL SİSTEMLERİ

## ALLUMINIUM CABLE TRUNKING SYSTEMS

Ref:104 50  
100 x 50

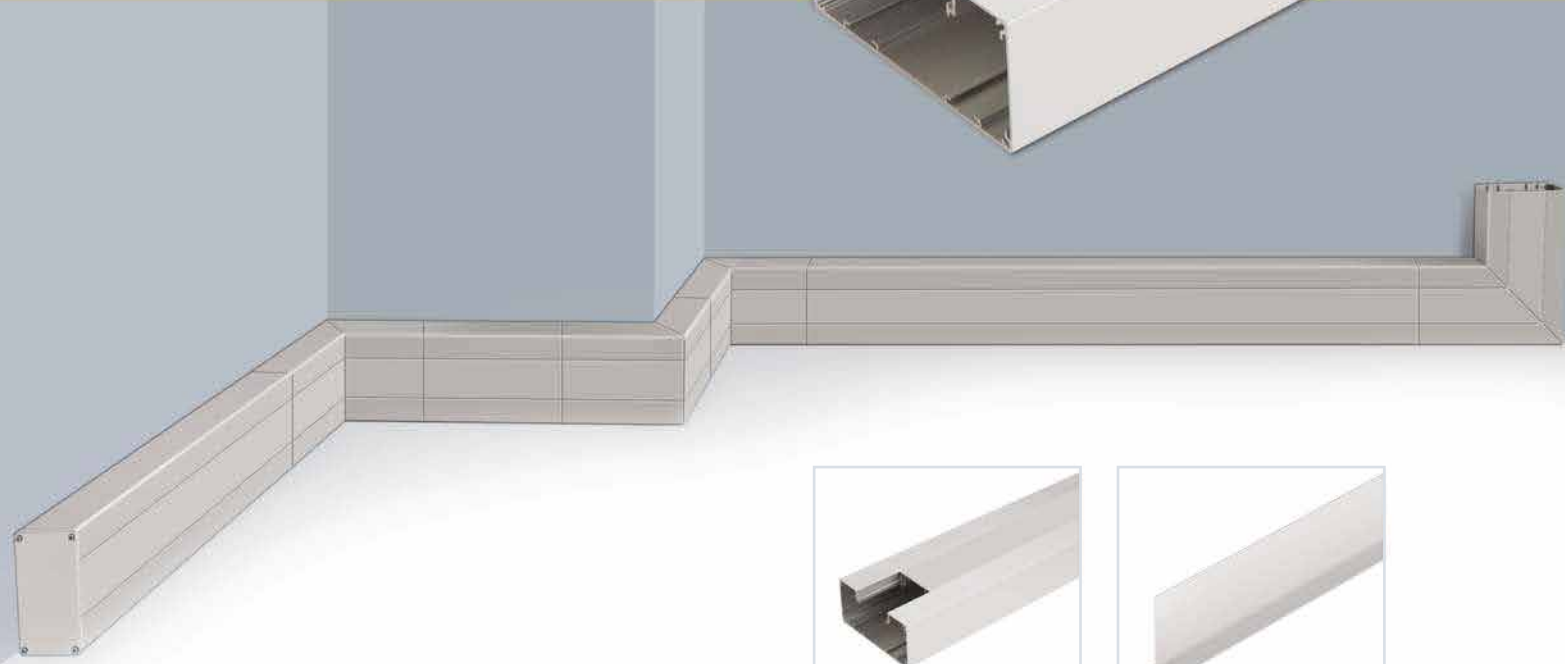

104 50

Ambalaj: 16 m  
104x50 Alüminyum Kablo Kanalı  
Packaging: 16 m  
Aluminium Cable Trunking



104 51

Ambalaj: 50m  
Ara bölme Uzunluk 2m  
Packaging: 50m  
Divider 2m length



104 01

İç Köşe (Hareketli)  
Internal Corner (Adjustable)



104 02

Dış Köşe (Hareketli)  
External Corner (Adjustable)



104 03

Dirsek 90° (Hareketli)  
90° Corner Piece (Adjustable)



104 04

T Dirsek  
T Corner

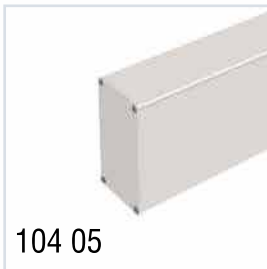

104 05

Sonlandırma Kapağı  
End Cover



104 08

Dörtlü Dirsek  
Quadro Corner



104 09

Yatay Birleştirme Parçası  
Horizontal Junction Piece



104 10

Dikey Birleştirme Parçası  
Vertical Junction Piece

Kanal üzerine çerçevesiz direk priz montajı  
Frameless socket assembling on cable trunking (Direct socket assembling)



**E**KO BEST SERİ KABLO KANALLARI  
ECO BEST LINE CABLE TRUNKING

EKO BEST SERİ KABLO KANALLARI ve AKSESUARLARI / ECO BEST LINE CABLE TRUNKING & ACCESSORIES

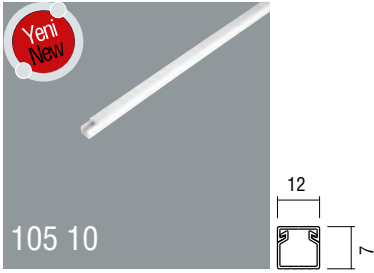

105 10

**10x10**

PVC Kablo Kanalı  
Kapaklı Satılır  
Ambalaj: 340m / 170 Boy  
10x10 PVC Cable Trunking  
Complete with cover  
Packaging: 340m / 170 Pcs

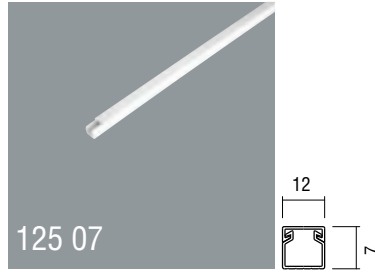

125 07

**12x7**

PVC Kablo Kanalı  
Kapaklı Satılır  
Ambalaj: 340m / 170 Boy  
12x7 PVC Cable Trunking  
Complete with cover  
Packaging: 340m / 170 Pcs

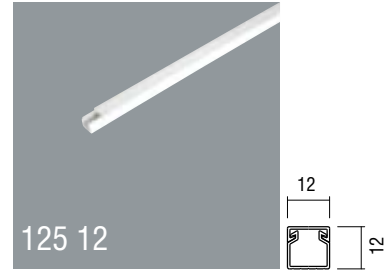

125 12

**12x12**

PVC Kablo Kanalı  
Kapaklı Satılır  
Ambalaj: 340m / 170 Boy  
12x12 PVC Cable Trunking  
Complete with cover  
Packaging: 340m / 170 Pcs

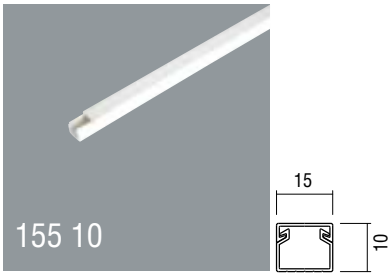

155 10

**15x10**

PVC Kablo Kanalı  
Kapaklı Satılır  
Ambalaj: 364m / 182 Boy  
15x10 PVC Cable Trunking  
Complete with cover  
Packaging: 364m / 182 Pcs

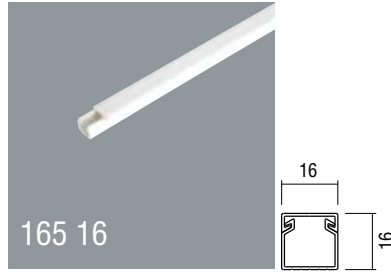

165 16

**16x16**

PVC Kablo Kanalı  
Kapaklı Satılır  
Ambalaj: 192m / 96 Boy  
16x16 PVC Cable Trunking  
Complete with cover  
Packaging: 192m / 96 Pcs

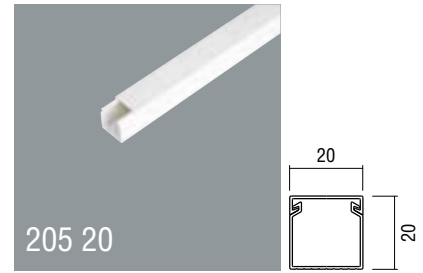

205 20

**20x20**

PVC Kablo Kanalı  
Kapaklı Satılır  
Ambalaj: 260m / 130 Boy  
20x20 PVC Cable Trunking  
Complete with cover  
Packaging: 260m / 130 Pcs

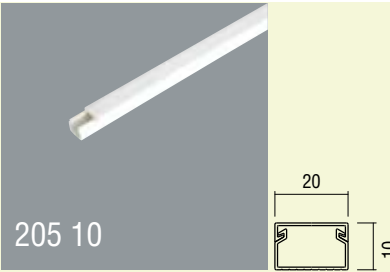

205 10

**20x10**

PVC Kablo Kanalı  
Kapaklı Satılır  
Ambalaj: 260m / 130 Boy  
20x10 PVC Cable Trunking  
Complete with cover  
Packaging: 260m / 130 Pcs

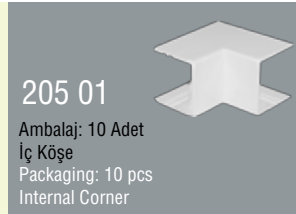

205 01

Ambalaj: 10 Adet  
İç Köşe  
Packaging: 10 pcs  
Internal Corner

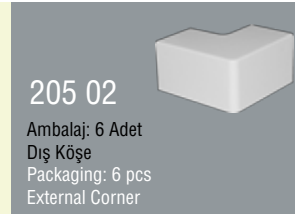

205 02

Ambalaj: 6 Adet  
Dış Köşe  
Packaging: 6 pcs  
External Corner

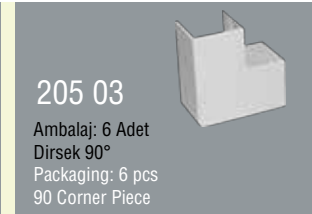

205 03

Ambalaj: 6 Adet  
Dirsek 90°  
Packaging: 6 pcs  
90 Corner Piece



205 04

Ambalaj: 8 Adet  
T Dirsek  
Packaging: 8 pcs  
T Corner

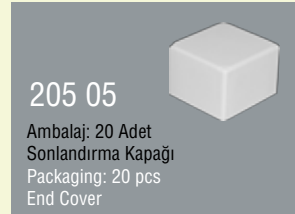

205 05

Ambalaj: 20 Adet  
Sonlandırma Kapağı  
Packaging: 20 pcs  
End Cover



205 06

Ambalaj: 20 Adet  
Kanal Birleştirme Parçası  
Packaging: 20 pcs  
Junction Piece

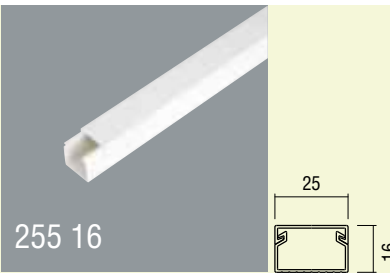

255 16

**25x16**

PVC Kablo Kanalı  
Kapaklı Satılır  
Ambalaj: 128m / 64 Boy  
25x16 PVC Cable Trunking  
Complete with cover  
Packaging: 128m / 64 Pcs



255 01

Ambalaj: 10 Adet  
İç Köşe  
Packaging: 10 pcs  
Internal Corner

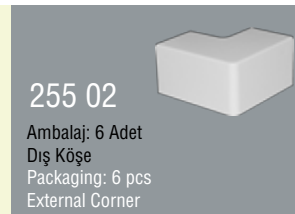

255 02

Ambalaj: 6 Adet  
Dış Köşe  
Packaging: 6 pcs  
External Corner



255 03

Ambalaj: 6 Adet  
Dirsek 90°  
Packaging: 6 pcs  
90 Corner Piece

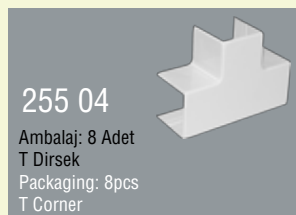

255 04

Ambalaj: 8 Adet  
T Dirsek  
Packaging: 8 pcs  
T Corner

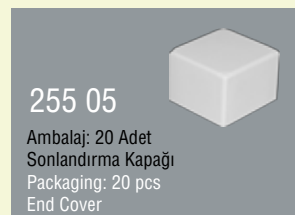

255 05

Ambalaj: 20 Adet  
Sonlandırma Kapağı  
Packaging: 20 pcs  
End Cover



255 06

Ambalaj: 20 Adet  
Kanal Birleştirme Parçası  
Packaging: 20 pcs  
Junction Piece

EKO BEST SERİ KABLO KANALLARI ve AKSESUARLARI / ECO BEST LINE CABLE TRUNKING & ACCESSORIES

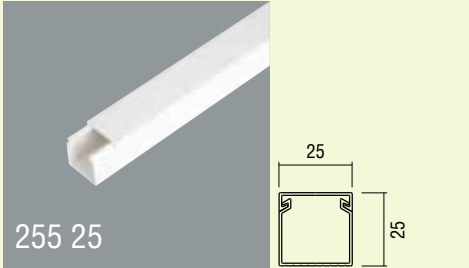

255 25

**25x25**

PVC Kablo Kanalı  
Kapaklı Satılır  
Ambalaj: 80m / 40 Boy  
25x25 PVC Cable Trunking  
Complete with cover  
Packaging: 80m / 40 Pcs



255 01

Ambalaj: 10 Adet  
İç Köşe  
Packaging: 10 pcs  
Internal Corner

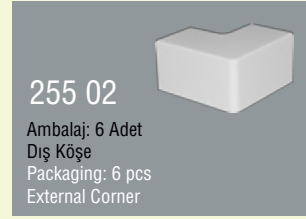

255 02

Ambalaj: 6 Adet  
Dış Köşe  
Packaging: 6 pcs  
External Corner

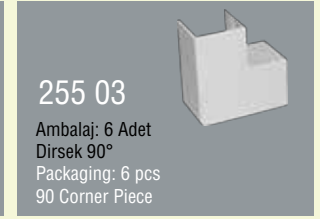

255 03

Ambalaj: 6 Adet  
Dirsek 90°  
Packaging: 6 pcs  
90 Corner Piece



255 04

Ambalaj: 8 Adet  
T Dirsek  
Packaging: 8pcs  
T Corner



255 05

Ambalaj: 20 Adet  
Sonlandırma Kapağı  
Packaging: 20 pcs  
End Cover



255 06

Ambalaj: 20 Adet  
Kanal Birleştirme Parçası  
Packaging: 20 pcs  
Junction Piece

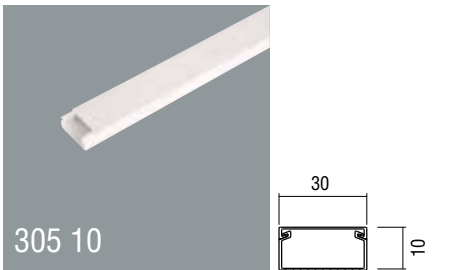

305 10

**30x10**

PVC Kablo Kanalı  
Kapaklı Satılır  
Ambalaj: 168m / 84 Boy  
30x10 PVC Cable Trunking  
Complete with cover  
Packaging: 168m / 84 Pcs

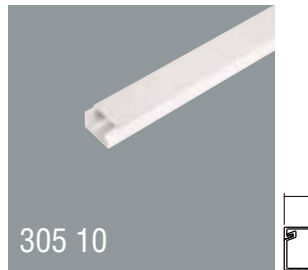

305 10

**30x10**

PVC Kablo Kanalı  
Kapaklı Satılır  
Ambalaj: 168m / 84 Boy  
30x10 PVC Cable Trunking  
Complete with cover, self divider  
Packaging: 168m / 84 Pcs

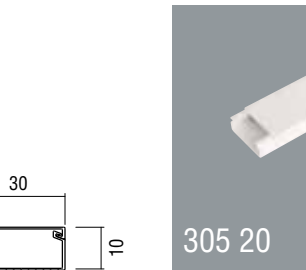

305 20

**30x20**

PVC Kablo Kanalı  
Kapaklı Satılır  
Ambalaj: 84m / 42 Boy  
30x20 PVC Cable Trunking  
Complete with cover  
Packaging: 84m / 42 Pcs

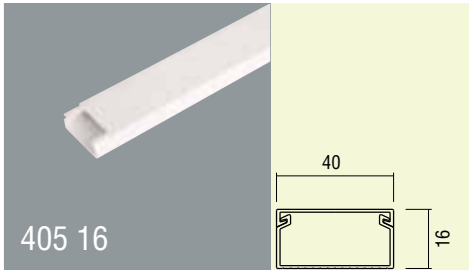

405 16

**40x16**

PVC Kablo Kanalı  
Kapaklı Satılır  
Ambalaj: 60m / 30 Boy  
40x16 PVC Cable Trunking  
Complete with cover  
Packaging: 60m / 30 Pcs



405 01

Ambalaj: 10 Adet  
İç Köşe  
Packaging: 10 pcs  
Internal Corner



405 02

Ambalaj: 6 Adet  
Dış Köşe  
Packaging: 6 pcs  
External Corner



405 03

Ambalaj: 6 Adet  
Dirsek 90°  
Packaging: 6 pcs  
90 Corner Piece



405 04

Ambalaj: 8 Adet  
T Dirsek  
Packaging: 8pcs  
T Corner



405 05

Ambalaj: 20 Adet  
Sonlandırma Kapağı  
Packaging: 20 pcs  
End Cover



405 06

Ambalaj: 20 Adet  
Kanal Birleştirme Parçası  
Packaging: 20 pcs  
Junction Piece

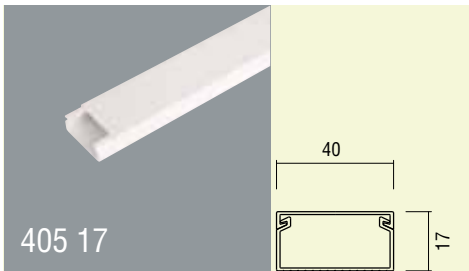

405 17

**40x17**

PVC Kablo Kanalı  
Kapaklı Satılır  
Ambalaj: 60m / 30 Boy  
40x17 PVC Cable Trunking  
Complete with cover  
Packaging: 60m / 30 Pcs

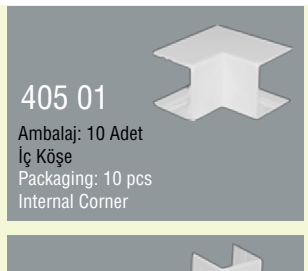

405 01

Ambalaj: 10 Adet  
İç Köşe  
Packaging: 10 pcs  
Internal Corner



405 02

Ambalaj: 6 Adet  
Dış Köşe  
Packaging: 6 pcs  
External Corner



405 03

Ambalaj: 6 Adet  
Dirsek 90°  
Packaging: 6 pcs  
90 Corner Piece



405 04

Ambalaj: 8 Adet  
T Dirsek  
Packaging: 8pcs  
T Corner



405 05

Ambalaj: 20 Adet  
Sonlandırma Kapağı  
Packaging: 20 pcs  
End Cover



405 06

Ambalaj: 20 Adet  
Kanal Birleştirme Parçası  
Packaging: 20 pcs  
Junction Piece



EKO BEST SERİ KABLO KANALLARI ve AKSESUARLARI / ECO BEST LINE CABLE TRUNKING & ACCESSORIES

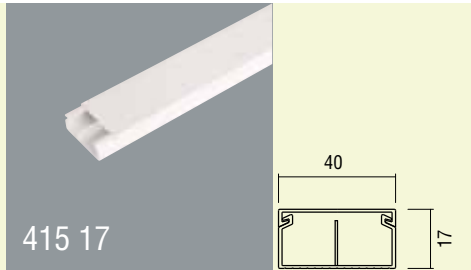

415 17

**40x17**

PVC Kablo Kanalı Ara Bölmeli  
Kapaklı Satılır  
Ambalaj: 60m / 30 Boy  
40x17 PVC Cable Trunking  
Complete with cover,  
Packaging: 60m / 30 Pcs



405 01

Ambalaj: 10 Adet  
İç Köşe  
Packaging: 10 pcs  
Internal Corner

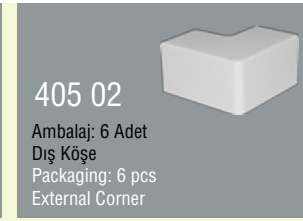

405 02

Ambalaj: 6 Adet  
Dış Köşe  
Packaging: 6 pcs  
External Corner

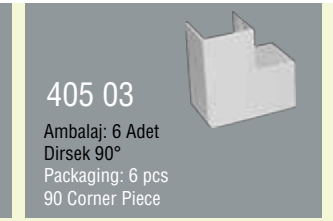

405 03

Ambalaj: 6 Adet  
Dirsek 90°  
Packaging: 6 pcs  
90 Corner Piece



405 04

Ambalaj: 8 Adet  
T Dirsek  
Packaging: 8 pcs  
T Corner

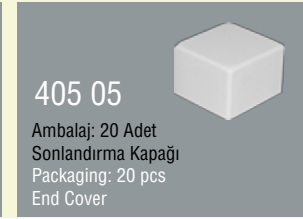

405 05

Ambalaj: 20 Adet  
Sonlandırma Kapağı  
Packaging: 20 pcs  
End Cover



405 06

Ambalaj: 20 Adet  
Kanal Birleştirme Parçası  
Packaging: 20 pcs  
Junction Piece

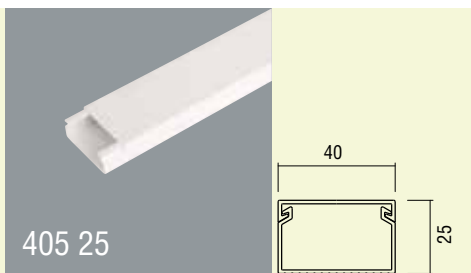

405 25

**40x25**

PVC Kablo Kanalı  
Kapaklı Satılır  
Ambalaj: 50m / 25 Boy  
40x25 PVC Cable Trunking  
Complete with cover  
Packaging: 50m / 25 Pcs



405 01

Ambalaj: 10 Adet  
İç Köşe  
Packaging: 10 pcs  
Internal Corner

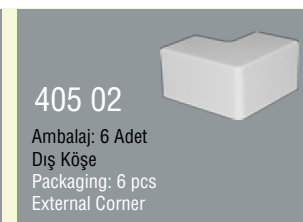

405 02

Ambalaj: 6 Adet  
Dış Köşe  
Packaging: 6 pcs  
External Corner

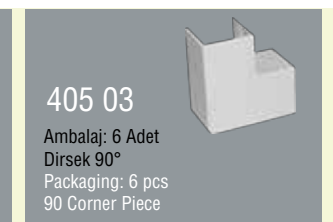

405 03

Ambalaj: 6 Adet  
Dirsek 90°  
Packaging: 6 pcs  
90 Corner Piece



405 04

Ambalaj: 8 Adet  
T Dirsek  
Packaging: 8 pcs  
T Corner



405 05

Ambalaj: 20 Adet  
Sonlandırma Kapağı  
Packaging: 20 pcs  
End Cover



405 06

Ambalaj: 20 Adet  
Kanal Birleştirme Parçası  
Packaging: 20 pcs  
Junction Piece

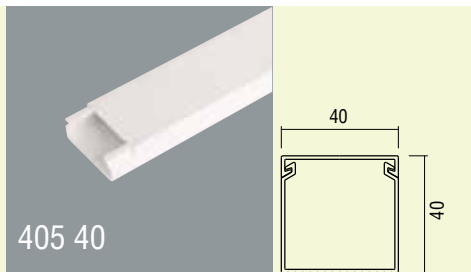

405 40

**40x40**

PVC Kablo Kanalı  
Kapaklı Satılır  
Ambalaj: 48m / 24 Boy  
40x40 PVC Cable Trunking  
Complete with cover  
Packaging: 48m / 24 Pcs



405 01

Ambalaj: 10 Adet  
İç Köşe  
Packaging: 10 pcs  
Internal Corner

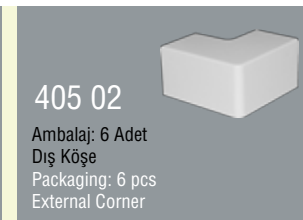

405 02

Ambalaj: 6 Adet  
Dış Köşe  
Packaging: 6 pcs  
External Corner

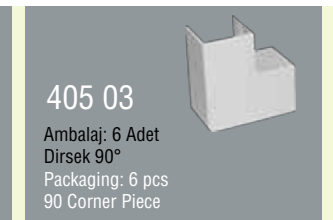

405 03

Ambalaj: 6 Adet  
Dirsek 90°  
Packaging: 6 pcs  
90 Corner Piece



405 04

Ambalaj: 8 Adet  
T Dirsek  
Packaging: 8 pcs  
T Corner



405 05

Ambalaj: 20 Adet  
Sonlandırma Kapağı  
Packaging: 20 pcs  
End Cover



405 06

Ambalaj: 20 Adet  
Kanal Birleştirme Parçası  
Packaging: 20 pcs  
Junction Piece

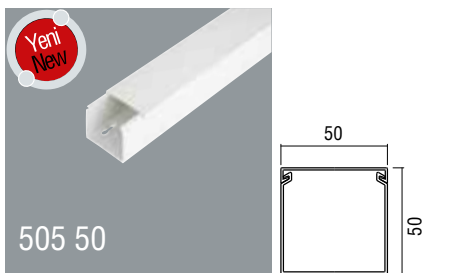

505 50

**50x50**

PVC Kablo Kanalı  
Kapaklı Satılır  
Ambalaj: 36m / 18 Boy  
50x50 PVC Cable Trunking  
Complete with cover  
Packaging: 36m / 18 Pcs



605 25

**60x25**

PVC Kablo Kanalı  
Kapaklı Satılır  
Ambalaj: 48m / 24 Boy  
60x25 PVC Cable Trunking  
Complete with cover  
Packaging: 48m / 24 Pcs

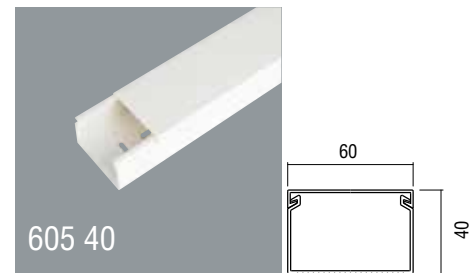

605 40

**60x40**

PVC Kablo Kanalı  
Kapaklı Satılır  
Ambalaj: 36m / 18 Boy  
60x40 PVC Cable Trunking  
Complete with cover  
Packaging: 36m / 18 Pcs

**EKO BEST SERİ KABLO KANALLARI ve AKSESUARLARI / ECO BEST LINE CABLE TRUNKING & ACCESSORIES**

605 60

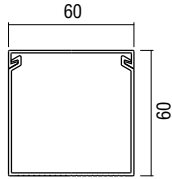
**60x60**

PVC Kablo Kanalı  
Kapaklı Satılır  
Ambalaj: 24m / 12 Boy  
60x60 PVC Cable Trunking  
Complete with cover  
Packaging: 24m / 12 Pcs

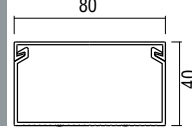

805 41

**80x40**

PVC Kablo Kanalı  
Kapaklı Satılır  
Ambalaj: 28m / 14 Boy  
80x40 PVC Cable Trunking  
Complete with cover  
Packaging: 28m / 14 Pcs

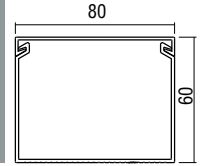

805 60

**80x60**

PVC Kablo Kanalı  
Kapaklı Satılır  
Ambalaj: 24m / 12 Boy  
80x60 PVC Cable Trunking  
Complete with cover  
Packaging: 24m / 12 Pcs

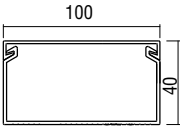

105 40

**100x40**

PVC Kablo Kanalı  
Kapaklı Satılır  
Ambalaj: 20m / 10 Boy  
100x40 PVC Cable Trunking  
Complete with cover  
Packaging: 20m / 10 Pcs

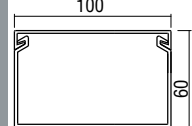

105 60

**100x60**

PVC Kablo Kanalı  
Kapaklı Satılır  
Ambalaj: 16m / 8 Boy  
100x60 PVC Cable Trunking  
Complete with cover  
Packaging: 16m / 8 Pcs

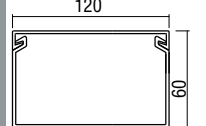

125 60

**120x60**

PVC Kablo Kanalı  
Kapaklı Satılır  
Ambalaj: 16m / 8 Boy  
120x60 PVC Cable Trunking  
Complete with cover  
Packaging: 16m / 8 Pcs

**BOYALI EKO BEST SERİ KABLO KANALLARI  
PAINTING ECO BEST LINE CABLE TRUNKING****16x16 • 25x16 • 25x25****40x25 • 102x50**

Kanal Ebatlarımızı

istediğiniz renk seçeneklerinde  
boyanabilir.

**16x16 • 25x16 • 25x25****40x25 • 102x50**

Sizes can be painted with  
the color you choose

Huş  
BirchMeşe  
OakCeviz  
Walnut

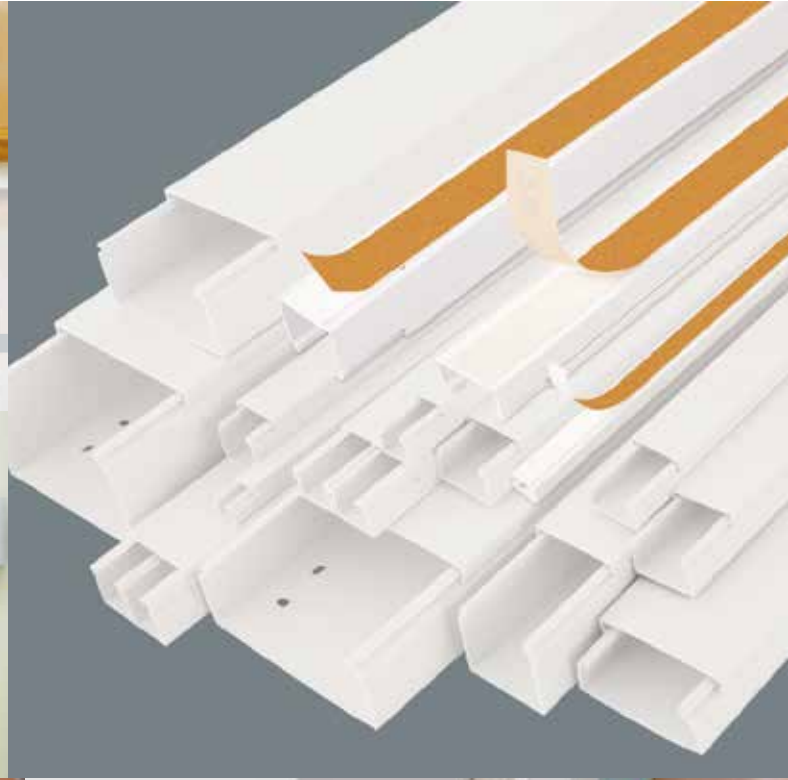

**E**KO BEST SERİ KENDİNDEN YAPIŞKANLI KABLO KANALLARI  
ECO BEST LINE SELF ADHESIVE CABLE TRUNKINGS

**EKO BEST SERİ KENDİNDEN YAPIŞKANLI KABLO KANALLARI ve AKSESUARLARI**  
**ECO BEST LINE SELF ADHESIVE CABLE TRUNKINGS & ACCESSORIES**

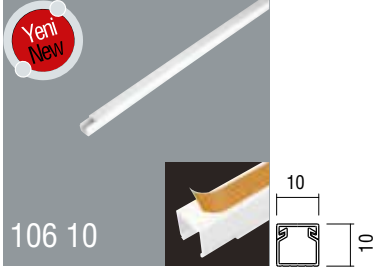

106 10

**10x10**

PVC Yapışkan Bantlı Kablo Kanalı  
Kapaklı Satılır  
Ambalaj: 340m / 170 Boy  
10x10 Self Adhesive PVC Cable Trunking  
With cover  
Packaging: 340m / 170 Pcs

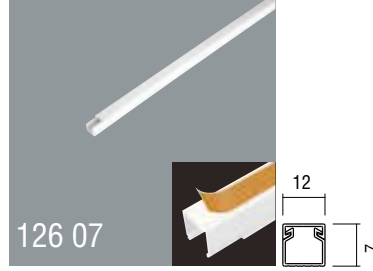

126 07

**12x7**

PVC Yapışkan Bantlı Kablo Kanalı  
Kapaklı Satılır  
Ambalaj: 340m / 170 Boy  
12x7 Self Adhesive PVC Cable Trunking  
With cover  
Packaging: 340m / 170 Pcs

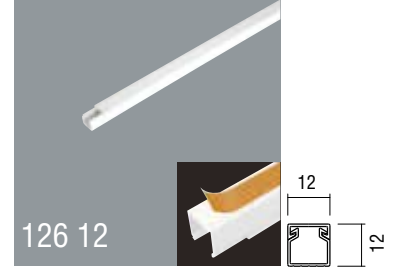

126 12

**12x12**

PVC Yapışkan Bantlı Kablo Kanalı  
Kapaklı Satılır  
Ambalaj: 340m / 170 Boy  
12x12 Self Adhesive PVC Cable Trunking  
With cover  
Packaging: 340m / 170 Pcs

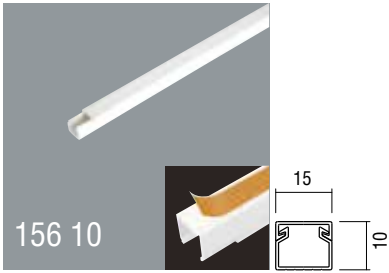

156 10

**15x10**

PVC Yapışkan Bantlı Kablo Kanalı  
Kapaklı Satılır  
Ambalaj: 364m / 182 Boy  
15x10 Self Adhesive PVC Cable Trunking  
With cover  
Packaging: 364m / 182 Pcs

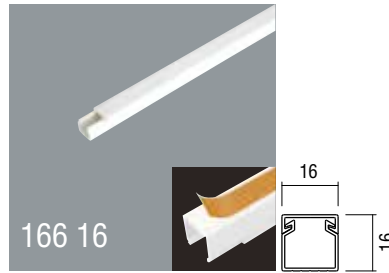

166 16

**16x16**

PVC Yapışkan Bantlı Kablo Kanalı  
Kapaklı Satılır  
Ambalaj: 192m / 96 Boy  
16x16 Self Adhesive PVC Cable Trunking  
With cover  
Packaging: 192m / 96 Pcs

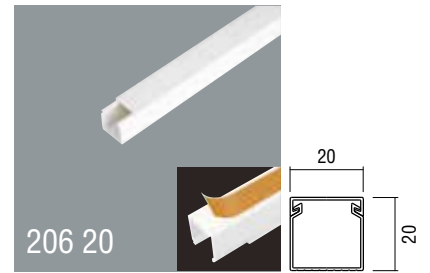

206 20

**20x20**

PVC Kablo Kanalı  
Kapaklı Satılır  
Ambalaj: 260m / 130 Boy  
20x20 PVC Cable Trunking  
Complete with cover  
Packaging: 260m / 130 Pcs

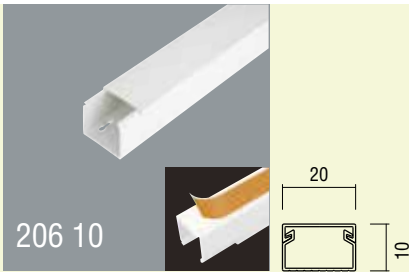

206 10

**20x10**

PVC Yapışkan Bantlı Kablo Kanalı  
Kapaklı Satılır  
Ambalaj: 260m / 130 Boy  
20x10 Self Adhesive PVC Cable Trunking  
With cover  
Packaging: 260m / 130 Pcs



205 01

Ambalaj: 10 Adet  
İç Köşe (Hareketli)  
Packaging: 10 pcs  
Internal Corner (Adjustable)

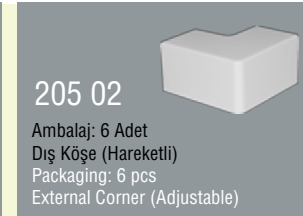

205 02

Ambalaj: 6 Adet  
Dış Köşe (Hareketli)  
Packaging: 6 pcs  
External Corner (Adjustable)

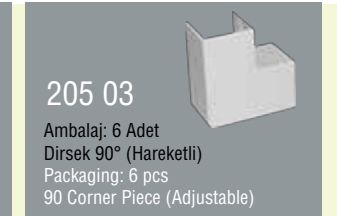

205 03

Ambalaj: 6 Adet  
Dirsek 90° (Hareketli)  
Packaging: 6 pcs  
90 Corner Piece (Adjustable)



205 04

Ambalaj: 8 Adet  
T Dirsek  
Packaging: 8 pcs  
T Corner



205 05

Ambalaj: 20 Adet  
Sonlandırma Kapağı  
Packaging: 20 pcs  
End Cover



205 06

Ambalaj: 20 Adet  
Kanal Birleştirme Parçası  
Packaging: 20 pcs  
Junction Piece

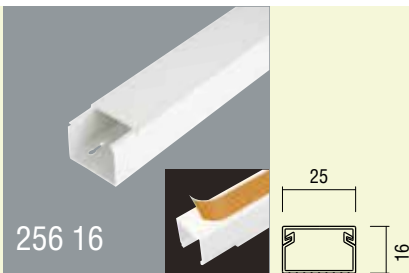

256 16

**25x16**

PVC Yapışkan Bantlı Kablo Kanalı  
Kapaklı Satılır  
Ambalaj: 128m / 64 Boy  
25x16 Self Adhesive PVC Cable Trunking  
With cover  
Packaging: 128m / 64 Pcs



255 01

Ambalaj: 10 Adet  
İç Köşe (Hareketli)  
Packaging: 10 pcs  
Internal Corner (Adjustable)

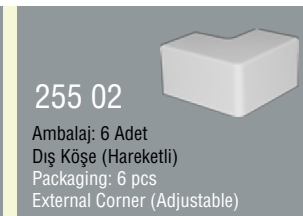

255 02

Ambalaj: 6 Adet  
Dış Köşe (Hareketli)  
Packaging: 6 pcs  
External Corner (Adjustable)

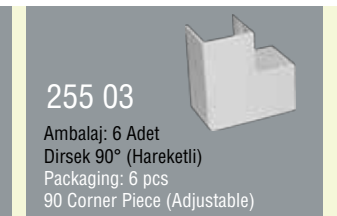

255 03

Ambalaj: 6 Adet  
Dirsek 90° (Hareketli)  
Packaging: 6 pcs  
90 Corner Piece (Adjustable)



255 04

Ambalaj: 8 Adet  
T Dirsek  
Packaging: 8 pcs  
T Corner

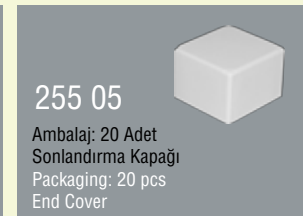

255 05

Ambalaj: 20 Adet  
Sonlandırma Kapağı  
Packaging: 20 pcs  
End Cover



255 06

Ambalaj: 20 Adet  
Kanal Birleştirme Parçası  
Packaging: 20 pcs  
Junction Piece

EKO BEST SERİ KENDİNDEN YAPIŞKANLI KABLO KANALLARI ve AKSESUARLARI  
ECO BEST LINE SELF ADHESIVE CABLE TRUNKINGS & ACCESSORIES

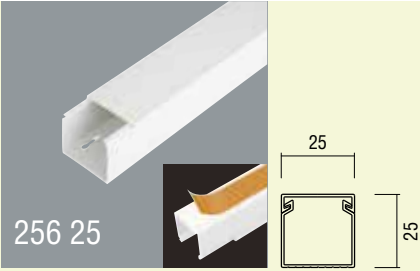

256 25

25x25

PVC Yapışkan Bantlı Kablo Kanalı  
Kapaklı Satılır  
Ambalaj: 80m / 40 Boy  
25x25 Self Adhesive PVC Cable Trunking  
With cover  
Packaging: 80m / 40 Pcs

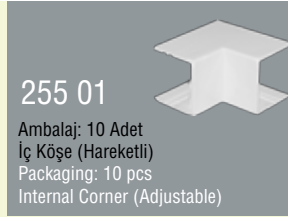

255 01

Ambalaj: 10 Adet  
İç Köşe (Hareketli)  
Packaging: 10 pcs  
Internal Corner (Adjustable)

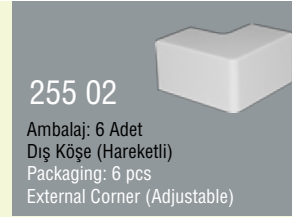

255 02

Ambalaj: 6 Adet  
Dış Köşe (Hareketli)  
Packaging: 6 pcs  
External Corner (Adjustable)

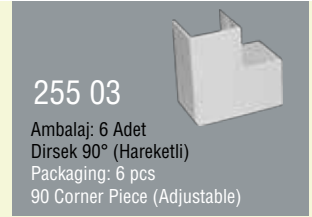

255 03

Ambalaj: 6 Adet  
Dirsek 90° (Hareketli)  
Packaging: 6 pcs  
90 Corner Piece (Adjustable)



255 04

Ambalaj: 8 Adet  
T Dirsek  
Packaging: 8pcs  
T Corner

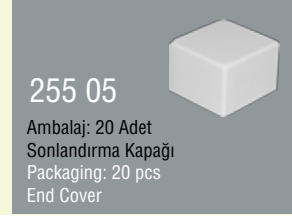

255 05

Ambalaj: 20 Adet  
Sonlandırma Kapağı  
Packaging: 20 pcs  
End Cover



255 06

Ambalaj: 20 Adet  
Kanal Birleştirme Parçası  
Packaging: 20 pcs  
Junction Piece

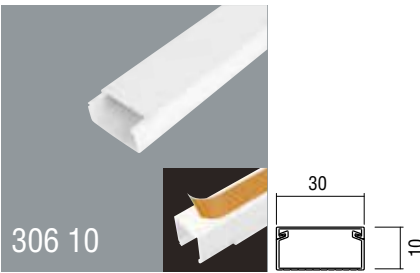

306 10

30x10

PVC Yapışkan Bantlı Kablo Kanalı  
Kapaklı Satılır  
Ambalaj: 168m / 84 Boy  
30x10 PVC Cable Trunking  
Complete with cover  
Packaging: 168m / 84 Pcs

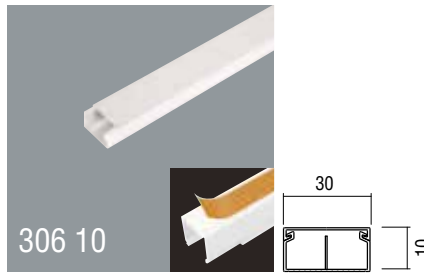

306 10

30x10

PVC Yapışkan Bantlı Kablo Kanalı Bölmeli  
Kapaklı Satılır  
Ambalaj: 168m / 84 Boy  
30x10 Self Adhesive PVC Cable Trunking  
with cover, self divider  
Packaging: 168m / 84 Pcs

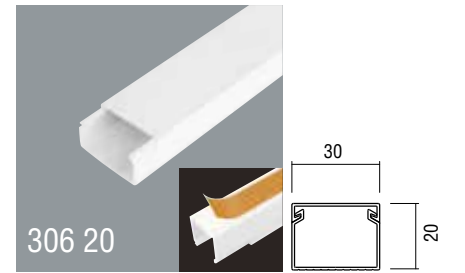

306 20

30x20

PVC Yapışkan Bantlı Kablo Kanalı  
Kapaklı Satılır  
Ambalaj: 84m / 42 Boy  
30x20 PVC Cable Trunking  
Complete with cover  
Packaging: 84m / 42 Pcs

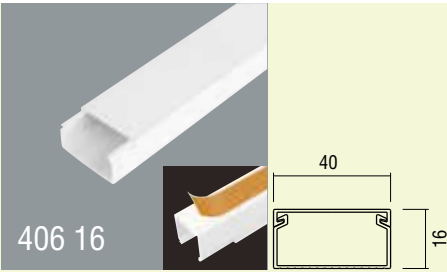

406 16

40x16

PVC Yapışkan Bantlı Kablo Kanalı  
Kapaklı Satılır  
Ambalaj: 60m / 30 Boy  
40x16 PVC Cable Trunking  
Complete with cover  
Packaging: 60m / 30 Pcs

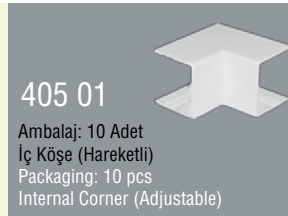

405 01

Ambalaj: 10 Adet  
İç Köşe (Hareketli)  
Packaging: 10 pcs  
Internal Corner (Adjustable)

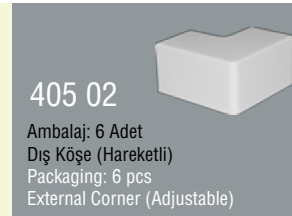

405 02

Ambalaj: 6 Adet  
Dış Köşe (Hareketli)  
Packaging: 6 pcs  
External Corner (Adjustable)



405 03

Ambalaj: 6 Adet  
Dirsek 90° (Hareketli)  
Packaging: 6 pcs  
90 Corner Piece (Adjustable)



405 04

Ambalaj: 8 Adet  
T Dirsek  
Packaging: 8pcs  
T Corner



405 05

Ambalaj: 20 Adet  
Sonlandırma Kapağı  
Packaging: 20 pcs  
End Cover



405 06

Ambalaj: 20 Adet  
Kanal Birleştirme Parçası  
Packaging: 20 pcs  
Junction Piece

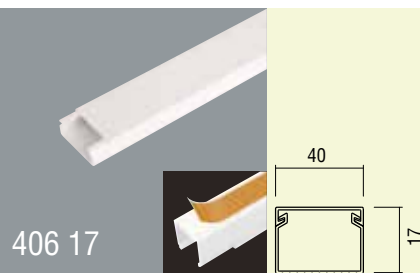

406 17

40x17

PVC Yapışkan Bantlı Kablo Kanalı  
Kapaklı Satılır  
Ambalaj: 60m / 30 Boy  
40x17 Self Adhesive PVC Cable Trunking  
With cover  
Packaging: 60m / 30 Pcs

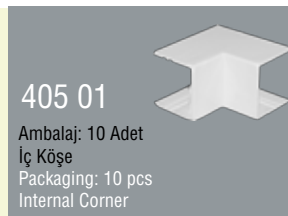

405 01

Ambalaj: 10 Adet  
İç Köşe  
Packaging: 10 pcs  
Internal Corner

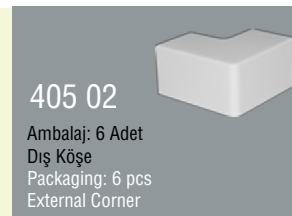

405 02

Ambalaj: 6 Adet  
Dış Köşe  
Packaging: 6 pcs  
External Corner



405 03

Ambalaj: 6 Adet  
Dirsek 90°  
Packaging: 6 pcs  
90 Corner Piece



405 04

Ambalaj: 8 Adet  
T Dirsek  
Packaging: 8pcs  
T Corner



405 05

Ambalaj: 20 Adet  
Sonlandırma Kapağı  
Packaging: 20 pcs  
End Cover



405 06

Ambalaj: 20 Adet  
Kanal Birleştirme Parçası  
Packaging: 20 pcs  
Junction Piece

**EKO BEST SERİ KENDİNDEN YAPIŞKANLI KABLO KANALLARI ve AKSESUARLARI**  
**ECO BEST LINE SELF ADHESIVE CABLE TRUNKINGS & ACCESSORIES**

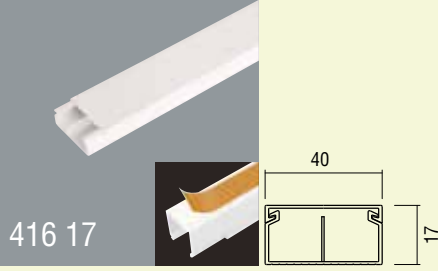

416 17

**40x17**  
PVC Yapışkan Bantlı Kablo Kanalı Bölmesi  
Kapaklı Satılır  
Ambalaj: 60m / 30 Boy  
40x17 PVC Cable Trunking  
Complete with cover, self divider  
Packaging: 60m / 30 Pcs

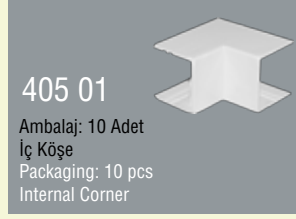

405 01

Ambalaj: 10 Adet  
İç Köşe  
Packaging: 10 pcs  
Internal Corner



405 02

Ambalaj: 6 Adet  
Dış Köşe  
Packaging: 6 pcs  
External Corner



405 03

Ambalaj: 6 Adet  
Dirsek 90°  
Packaging: 6 pcs  
90 Corner Piece



405 04

Ambalaj: 8 Adet  
T Dirsek  
Packaging: 8 pcs  
T Corner



405 05

Ambalaj: 20 Adet  
Sonlandırma Kapağı  
Packaging: 20 pcs  
End Cover



405 06

Ambalaj: 20 Adet  
Kanal Birleştirme Parçası  
Packaging: 20 pcs  
Junction Piece

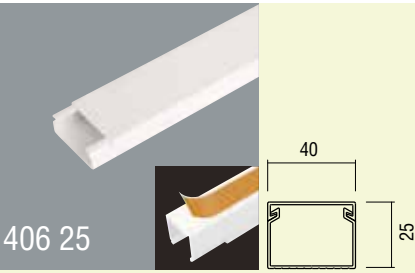

406 25

**40x25**  
PVC Yapışkan Bantlı Kablo Kanalı  
Kapaklı Satılır  
Ambalaj: 50m / 25 Boy  
40x25 Self Adhesive PVC Cable Trunking  
With cover  
Packaging: 50m / 25 Pcs

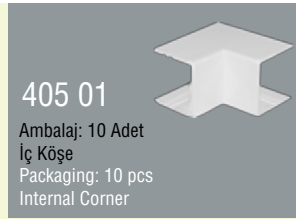

405 01

Ambalaj: 10 Adet  
İç Köşe  
Packaging: 10 pcs  
Internal Corner

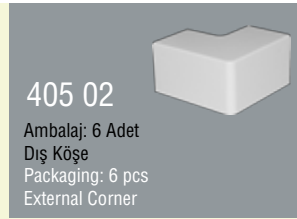

405 02

Ambalaj: 6 Adet  
Dış Köşe  
Packaging: 6 pcs  
External Corner

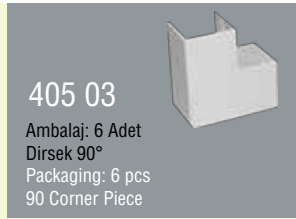

405 03

Ambalaj: 6 Adet  
Dirsek 90°  
Packaging: 6 pcs  
90 Corner Piece

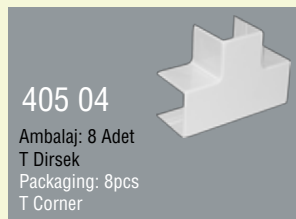

405 04

Ambalaj: 8 Adet  
T Dirsek  
Packaging: 8 pcs  
T Corner

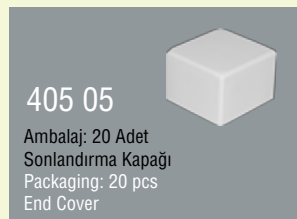

405 05

Ambalaj: 20 Adet  
Sonlandırma Kapağı  
Packaging: 20 pcs  
End Cover



405 06

Ambalaj: 20 Adet  
Kanal Birleştirme Parçası  
Packaging: 20 pcs  
Junction Piece

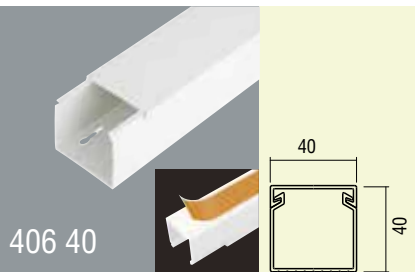

406 40

**40x40**  
PVC Yapışkan Bantlı Kablo Kanalı  
Kapaklı Satılır  
Ambalaj: 48m / 24 Boy  
40x40 Self Adhesive PVC Cable Trunking  
With cover  
Packaging: 48m / 24 Pcs



405 01

Ambalaj: 10 Adet  
İç Köşe  
Packaging: 10 pcs  
Internal Corner

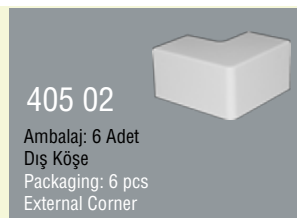

405 02

Ambalaj: 6 Adet  
Dış Köşe  
Packaging: 6 pcs  
External Corner

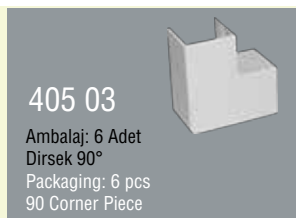

405 03

Ambalaj: 6 Adet  
Dirsek 90°  
Packaging: 6 pcs  
90 Corner Piece

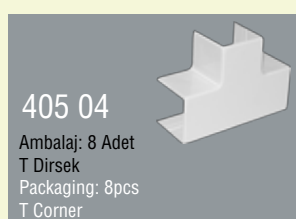

405 04

Ambalaj: 8 Adet  
T Dirsek  
Packaging: 8 pcs  
T Corner



405 05

Ambalaj: 20 Adet  
Sonlandırma Kapağı  
Packaging: 20 pcs  
End Cover



405 06

Ambalaj: 20 Adet  
Kanal Birleştirme Parçası  
Packaging: 20 pcs  
Junction Piece

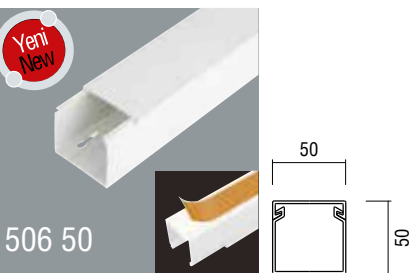

506 50

**50x50**  
PVC Yapışkan Bantlı Kablo Kanalı  
Kapaklı Satılır  
Ambalaj: 36m / 18 Boy  
50x50 Self Adhesive PVC Cable Trunking  
With cover  
Packaging: 36m / 18 Pcs

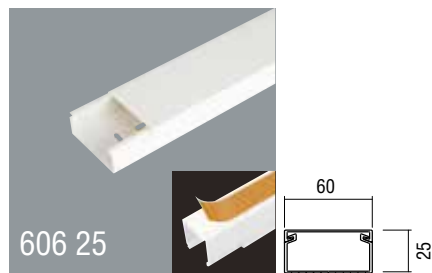

606 25

**60x25**  
PVC Kablo Kanalı  
Kapaklı Satılır  
Ambalaj: 48m / 24 Boy  
30x10 PVC Cable Trunking  
Complete with cover  
Packaging: 60m / 25 Pcs

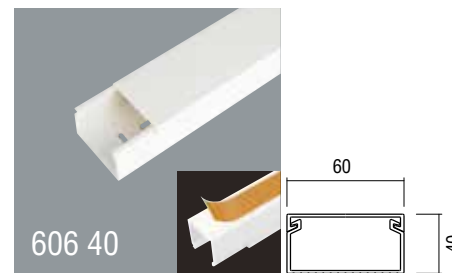

606 40

**60x40**  
PVC Kablo Kanalı Bölmesiz  
Kapaklı Satılır  
Ambalaj: 36m / 18 Boy  
60x40 PVC Cable Trunking  
Complete with cover  
Packaging: 60m / 30 Pcs



**C**ANAFIX SERİ KABLO KANALLARI  
CANAFIX LINE CABLE TRUNKINGS

CANAFIX SERİ KABLO KANALLARI ve AKSESUARLARI / CANAFIX LINE CABLE TRUNKING & ACCESSORIES

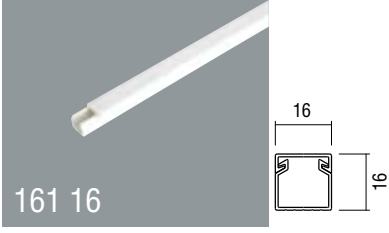

161 16

**16x16**

PVC Kablo Kanalı  
Kapaklı Satılır

Ambalaj: 192m / 96 Boy

16x16 PVC Cable Trunking  
Complete with cover

Packaging: 192m / 96 Pcs

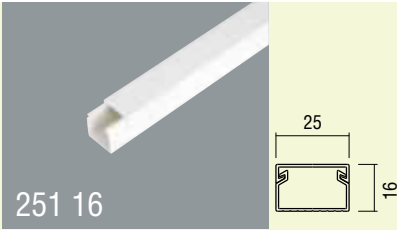

251 16

**25x16**

PVC Kablo Kanalı  
Kapaklı Satılır

Ambalaj: 128m / 64 Boy

25x16 PVC Cable Trunking  
Complete with cover

Packaging: 128m / 64 Pcs



255 01

Ambalaj: 10 Adet  
İç Köşe  
Packaging: 10 pcs  
Internal Corner

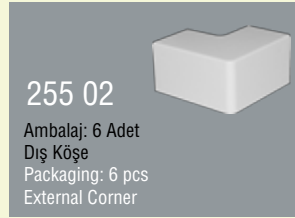

255 02

Ambalaj: 6 Adet  
Dış Köşe  
Packaging: 6 pcs  
External Corner

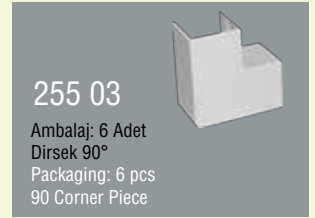

255 03

Ambalaj: 6 Adet  
Dirsek 90°  
Packaging: 6 pcs  
90 Corner Piece

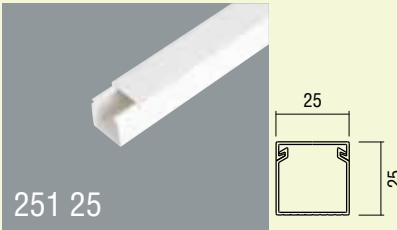

251 25

**25x25**

PVC Kablo Kanalı  
Kapaklı Satılır

Ambalaj: 80m / 40 Boy

25x25 PVC Cable Trunking  
Complete with cover

Packaging: 80m / 40 Pcs



255 04

Ambalaj: 8 Adet  
T Dirsek  
Packaging: 8 pcs  
T Corner



255 05

Ambalaj: 20 Adet  
Sonlandırma Kapağı  
Packaging: 20 pcs  
End Cover



255 06

Ambalaj: 20 Adet  
Kanal Birleştirme Parçası  
Packaging: 20 pcs  
Junction Piece

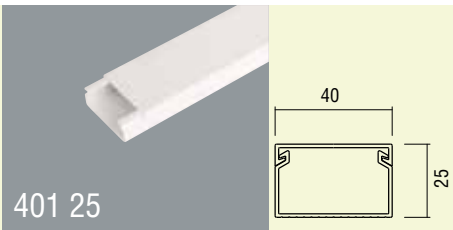

401 25

**40x25**

PVC Kablo Kanalı  
Kapaklı Satılır

Ambalaj: 50m / 25 Boy

40x25 PVC Cable Trunking  
Complete with cover

Packaging: 50m / 25 Pcs



405 01

Ambalaj: 10 Adet  
İç Köşe  
Packaging: 10 pcs  
Internal Corner

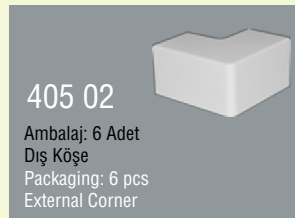

405 02

Ambalaj: 6 Adet  
Dış Köşe  
Packaging: 6 pcs  
External Corner



405 03

Ambalaj: 6 Adet  
Dirsek 90°  
Packaging: 6 pcs  
90 Corner Piece

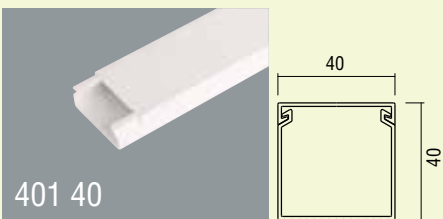

401 40

**40x40**

PVC Kablo Kanalı  
Kapaklı Satılır

Ambalaj: 48m / 24 Boy

40x40 PVC Cable Trunking  
Complete with cover

Packaging: 48m / 24 Pcs

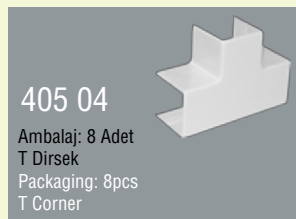

405 04

Ambalaj: 8 Adet  
T Dirsek  
Packaging: 8 pcs  
T Corner

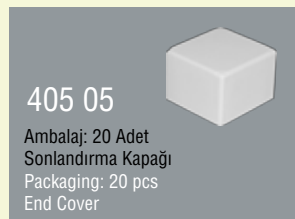

405 05

Ambalaj: 20 Adet  
Sonlandırma Kapağı  
Packaging: 20 pcs  
End Cover



405 06

Ambalaj: 20 Adet  
Kanal Birleştirme Parçası  
Packaging: 20 pcs  
Junction Piece





**C**ANAFIX SERİ KENDİNDEN YAPIŞKANLI KABLO KANALLARI  
CANAFIX LINE SELF ADHESIVE CABLE TRUNKINGS

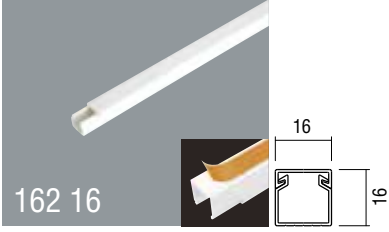

162 16

**16x16**

PVC Kablo Kanalı

Kapaklı Satılır

Ambalaj: 192m / 96 Boy

16x16 PVC Cable Trunking

Complete with cover

Packaging: 192m / 96 Pcs

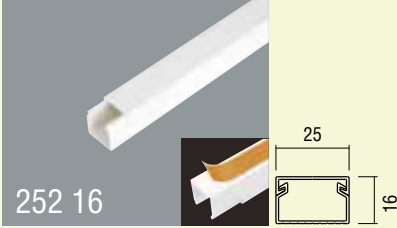

252 16

**25x16**

PVC Kablo Kanalı

Kapaklı Satılır

Ambalaj: 128m / 64 Boy

25x16 PVC Cable Trunking

Complete with cover

Packaging: 128m / 64 Pcs

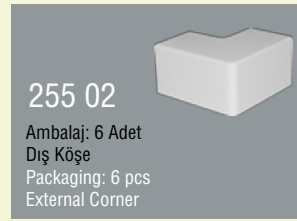

255 01

Ambalaj: 10 Adet  
İç Köşe  
Packaging: 10 pcs  
Internal Corner

255 02

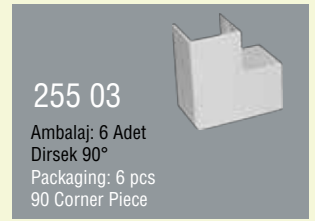
Ambalaj: 6 Adet  
Dış Köşe  
Packaging: 6 pcs  
External Corner

255 03

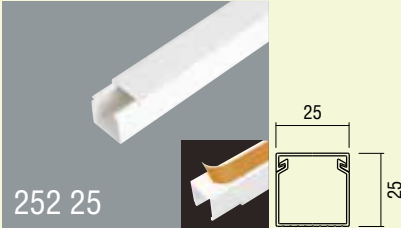
Ambalaj: 6 Adet  
Dirsek 90°  
Packaging: 6 pcs  
90 Corner Piece

252 25

**25x25**

PVC Kablo Kanalı

Kapaklı Satılır

Ambalaj: 80m / 40 Boy

25x25 PVC Cable Trunking

Complete with cover

Packaging: 80m / 40 Pcs

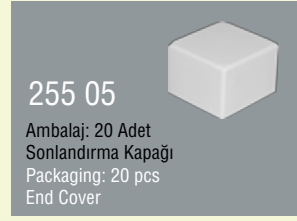

255 04

Ambalaj: 8 Adet  
T Dirsek  
Packaging: 8 pcs  
T Corner

255 05

Ambalaj: 20 Adet  
Sonlandırma Kapağı  
Packaging: 20 pcs  
End Cover

255 06

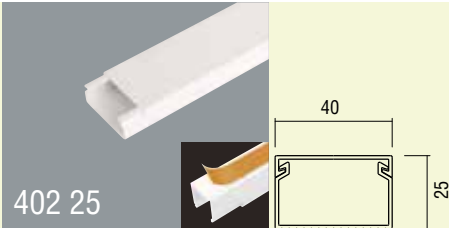
Ambalaj: 20 Adet  
Kanal Birleştirme Parçası  
Packaging: 20 pcs  
Junction Piece

402 25

**40x25**

PVC Kablo Kanalı

Kapaklı Satılır

Ambalaj: 50m / 25 Boy

40x25 PVC Cable Trunking

Complete with cover

Packaging: 50m / 25 Pcs

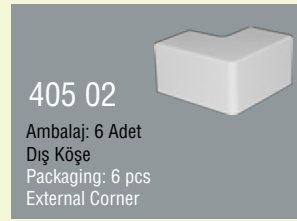

405 01

Ambalaj: 10 Adet  
İç Köşe  
Packaging: 10 pcs  
Internal Corner

405 02

Ambalaj: 6 Adet  
Dış Köşe  
Packaging: 6 pcs  
External Corner

405 03

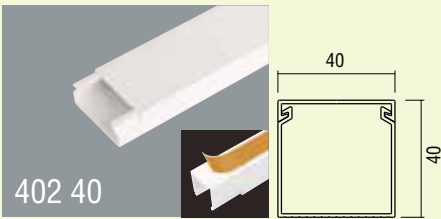
Ambalaj: 6 Adet  
Dirsek 90°  
Packaging: 6 pcs  
90 Corner Piece

402 40

**40x40**

PVC Kablo Kanalı

Kapaklı Satılır

Ambalaj: 48m / 24 Boy

40x40 PVC Cable Trunking

Complete with cover

Packaging: 48m / 24 Pcs

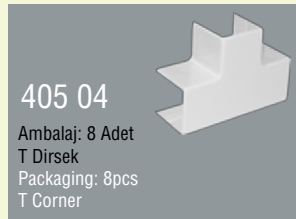

405 04

Ambalaj: 8 Adet  
T Dirsek  
Packaging: 8 pcs  
T Corner

405 05

Ambalaj: 20 Adet  
Sonlandırma Kapağı  
Packaging: 20 pcs  
End Cover

405 06

Ambalaj: 20 Adet  
Kanal Birleştirme Parçası  
Packaging: 20 pcs  
Junction Piece



**D**ÖŞEME ÜSTÜ KABLO KANAL SİSTEMLERİ  
OVERFLOOR CABLE TRUNKING SYSTEMS

**DÖŞEMEÜSTÜ KABLO KANALLARI**  
**OVERFLOOR CABLE TRUNKS SYSTEMS**



520 12

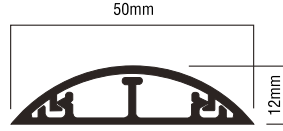

**50x12**

PVC Kanal / PVC Trunk  
Uzunluk 2m / Length 2m  
Ambalaj: 72m / Packaging: 72m  
Kesit 50x12mm / Size 50x12mm  
Kapaklı Satılır / Complete with cover  
Kendinden Ara Bölmeli / Produced with self-separator Part  
Renk RAL 7023 Gri / Grey Color RAL 7023



900 22

**ALUMİNYUM**  
**ALUMINIUM**

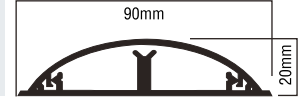

**90x20**

Aluminyum Kanal / Alluminium Trunk  
Uzunluk 2m / Length 2m  
Ambalaj: 24m / Packaging: 24m  
Kesit 90x20mm / Size 90x20mm  
Kapaklı Satılır / Complete with cover  
Kendinden Ara Bölmeli / Produced with self-separator Part



750 20

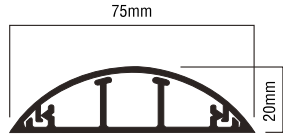

**75x20**

PVC Kanal / PVC Trunk  
Uzunluk 2m / Length 2m  
Ambalaj: 32m / Packaging: 32m  
Kesit 75x20mm / Size 75x20mm  
Kapaklı Satılır / With cover  
Kendinden Ara Bölmeli / Produced with self-separator Part  
Renk RAL 7023 Gri / Grey Color RAL 7023



750 21

**L Dirsek/L Corner**  
Ambalaj: 20 adet  
Packaging: 20Pieces



750 22

**T Dirsek/T Corner**  
Ambalaj: 20 adet  
Packaging: 20Pieces



750 23

**Sonlandırma End Cover**  
Ambalaj: 20 adet  
Packaging: 20Pieces



750 24

**Kanal Birleştirme Parçası Junction Piece**  
Ambalaj: 20 adet  
Packaging: 20Pieces



900 20

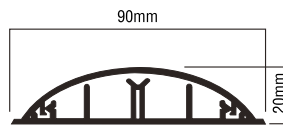

**90x20**

PVC Kanal / PVC Cable Trunking  
Uzunluk 2m / Length 2m  
Ambalaj: 24m / Packaging: 24m  
Kesit 90x20mm / Size 90x20mm  
Kapaklı Satılır / With cover  
Kendinden Ara Bölmeli / Produced with self-separator Part  
Renk RAL 7023 Gri / Grey Color RAL 7023



900 21

**L Dirsek/L Corner**  
Ambalaj: 20 adet  
Packaging: 20Pieces



900 22

**T Dirsek/T Corner**  
Ambalaj: 20 adet  
Packaging: 20Pieces



900 23

**Sonlandırma End Cover**  
Ambalaj: 20 adet  
Packaging: 20Pieces



900 24

**Kanal Birleştirme Parçası Junction Piece**  
Ambalaj: 20 adet  
Packaging: 20Pieces



Kanalları istediğiniz renk seçeneklerinde boyanabilir.  
Can be painted with the color you choose

**KENDİNDEN YAPIŞKANLI**  
**DÖŞEMEÜSTÜ KABLO**  
**KANALLARI**

**SELF ADHESIVE**  
**OVERFLOOR CABLE**  
**TRUNKS SYSTEMS**



521 12



751 20



901 20



**D** LX LINE DELİKLİ PANO KANALLARI  
DLX LINE SLOTTED CABLE TRUNKINGS

Tabanındaki delikler sayesinde hızlı ve kolay montaj sağlar.

Holes in the base allows quick and easy installation



Kolay açılıp kapanma ile birlikte ekstra dayanıklılık sağlayan kapak ve gövde birleşimi.

The combination of the body and cover parts provide extra durability with its unique easy opening and design features.

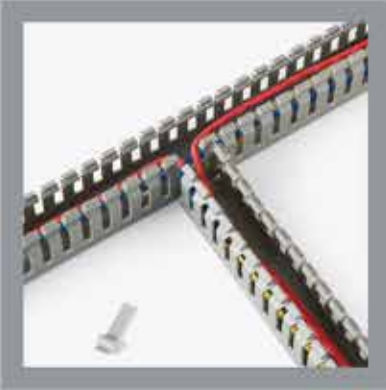

Tırnakları kırarak dilediğiniz yerden T bağlantılar yapabilirsiniz.

T connections can be made by breaking side nails.

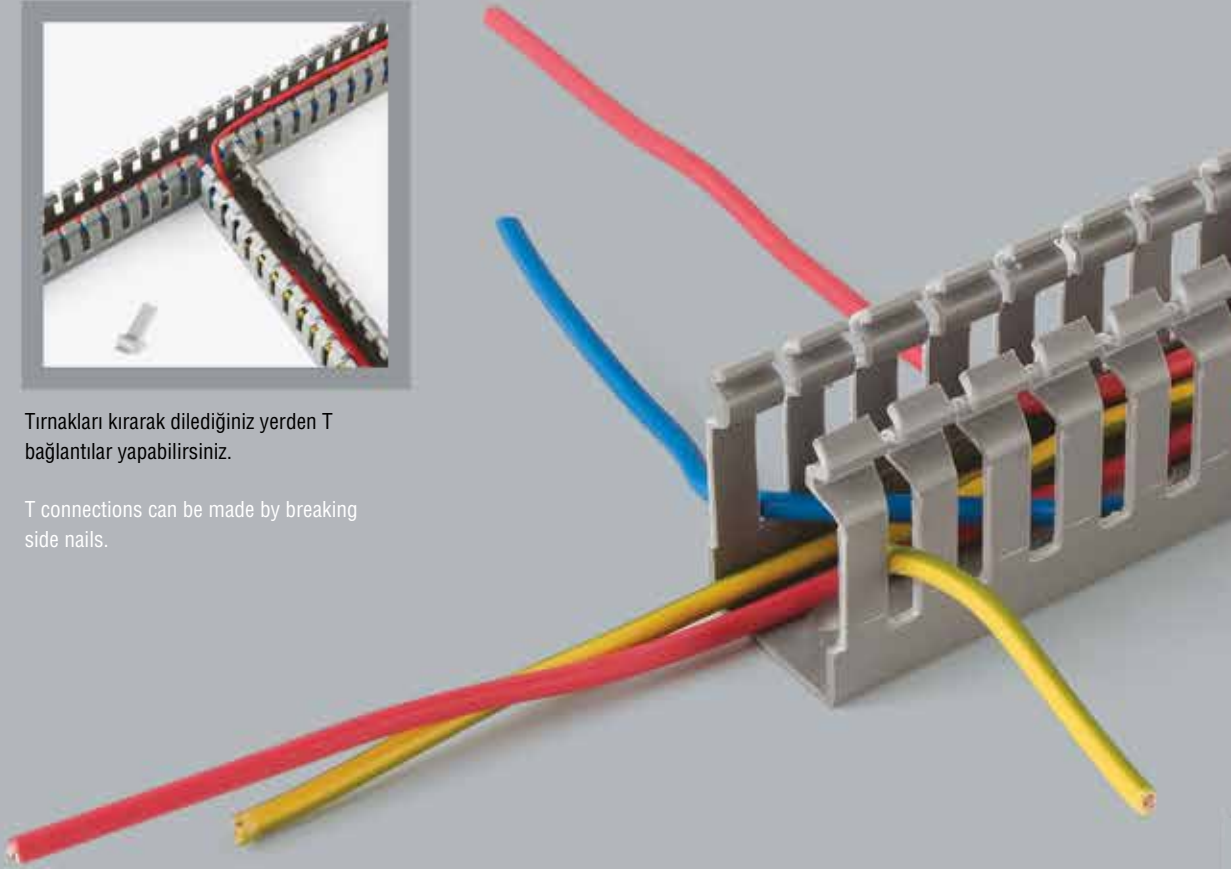

## **T**EKNIK ÖZELLİKLER TECHNICAL DETAILS

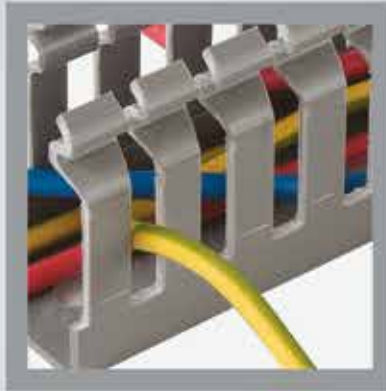
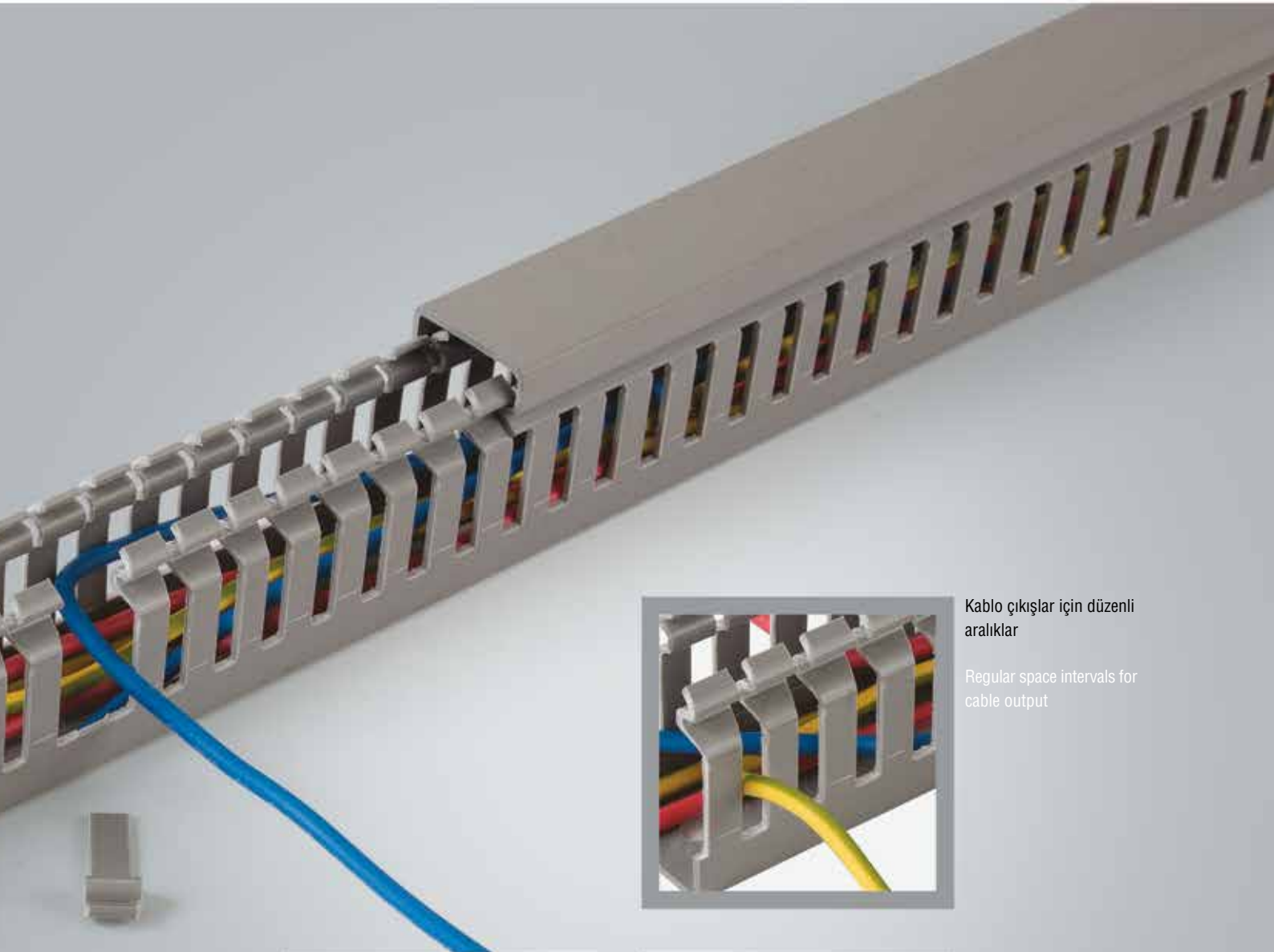

Kablo çıkışlar için düzenli aralıklar

Regular space intervals for cable output



Kesici aletlerle kolayca dilediğiniz ebatta kesebilirsiniz.

With Special Cutting tools, you can easily cut the trunking as your desired size.

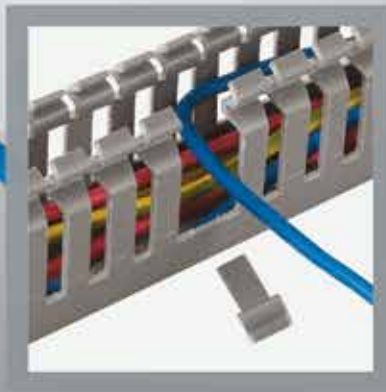

Önceden belirlenmiş kırılma hatları sayesinde dilediğiniz kadar kanal birleştirme ve kablo çıkışı yapabilirsiniz.

With its predesigned breaking lines, it is comfortable to make a vast unit of cable joint and cable outputs.

## DLX LINE DELİKLİ PANO KANAL KAPAĞI DLX LINE SLOTTED CABLE TRUNKINGS COVER



**Ambalaj  
Package**

<b>257 26</b>	25'lik Kapak/Cover	80m
<b>407 41</b>	40'lık Kapak/Cover	60m
<b>607 61</b>	60'lık Kapak/Cover	40m
<b>807 81</b>	80'lık Kapak/Cover	30m



**Ambalaj  
Package**

<b>259 26</b>	25'lik Kapak/Cover	80m
<b>409 41</b>	40'lık Kapak/Cover	60m
<b>609 61</b>	60'lık Kapak/Cover	40m
<b>809 81</b>	80'lık Kapak/Cover	30m

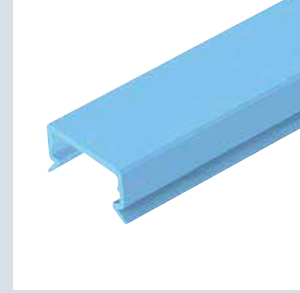

**Ambalaj  
Package**

<b>258 26</b>	25'lik Kapak/Cover	80m
<b>408 41</b>	40'lık Kapak/Cover	60m
<b>608 61</b>	60'lık Kapak/Cover	40m
<b>808 81</b>	80'lık Kapak/Cover	30m

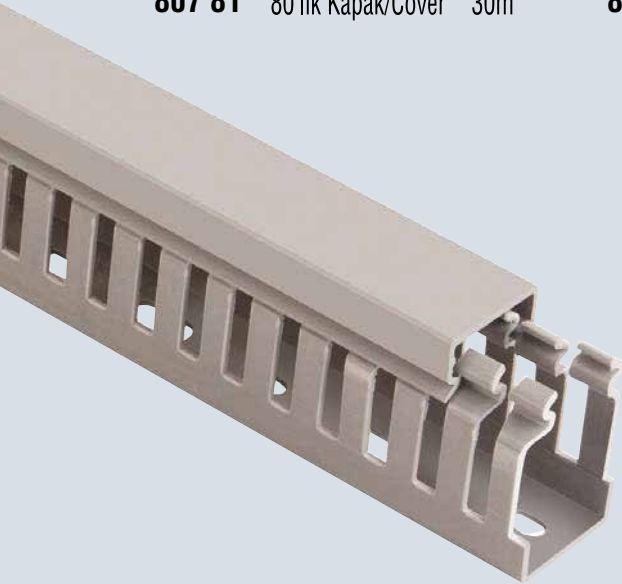

### Özellikler

- Sert PVC UL94V0 M1 Alev Yayımayan
- Çalışma Ortam Sıcaklığı: -20° C +60° C
- Ral 7030 Gri

### Features

- Rigid PVC UL94V0 M1 Self-extinguishing
- Temperature-Resistant: -20° C +60° C
- Ral 7030 Gri

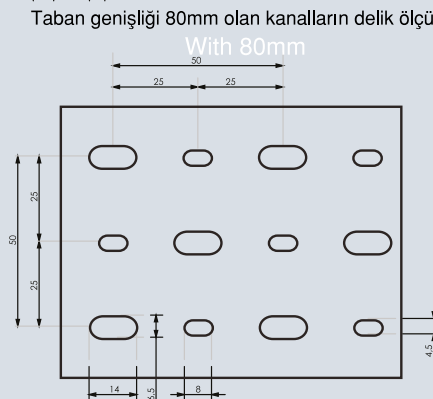
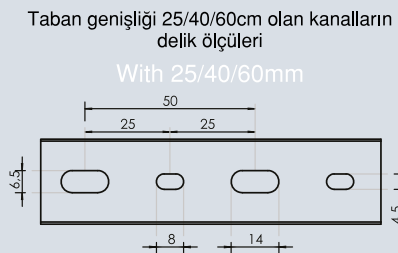
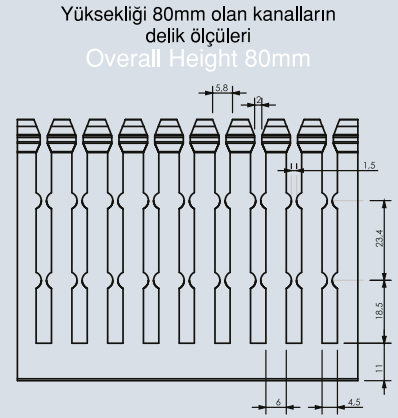
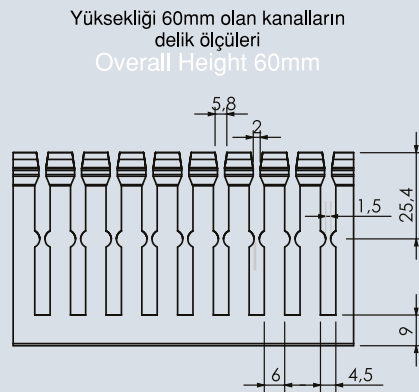
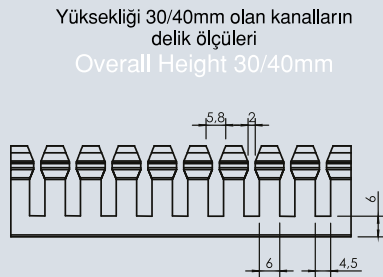



## DLX LINE DELİKLİ PANO KANALLARI DLX LINE SLOTTED CABLE TRUNKINGS



257 25

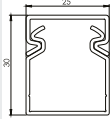

**25x25**

PVC Kablo Kanalı  
Kapaklı Satılır  
Ambalaj: 100m  
Renk: Gri RAL7030  
25x25 Slotted Cable Trunking  
Complete with cover  
Packaging: 100m  
Color: Grey RAL 7030



257 40

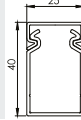

**25x40**

PVC Kablo Kanalı  
Kapaklı Satılır  
Ambalaj: 80m  
Renk: Gri RAL7030  
25x40 Slotted Cable Trunking  
Complete with cover  
Packaging: 80m  
Color: Grey RAL 7030



257 60

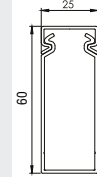

**25x60**

PVC Kablo Kanalı  
Kapaklı Satılır  
Ambalaj: 72m  
Renk: Gri RAL7030  
25x60 Slotted Cable Trunking  
Complete with cover  
Packaging: 72m  
Color: Grey RAL 7030



407 40

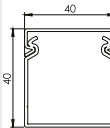

**40x40**

PVC Kablo Kanalı  
Kapaklı Satılır  
Ambalaj: 50m  
Renk: Gri RAL7030  
40x40 Slotted Cable Trunking  
Complete with cover  
Packaging: 50m  
Color: Grey RAL 7030



407 60

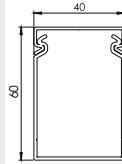

**40x60**

PVC Kablo Kanalı  
Kapaklı Satılır  
Ambalaj: 40m  
Renk: Gri RAL7030  
40x60 Slotted Cable Trunking  
Complete with cover  
Packaging: 40m  
Color: Grey RAL 7030



607 60

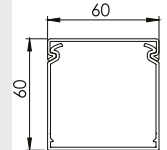

**60x60**

PVC Kablo Kanalı  
Kapaklı Satılır  
Ambalaj: 32m  
Renk: Gri RAL7030  
60x60 Slotted Cable Trunking  
Complete with cover  
Packaging: 32m  
Color: Grey RAL 7030



807 60

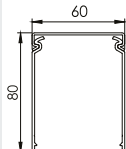

**80x60**

PVC Kablo Kanalı  
Kapaklı Satılır  
Ambalaj: 24m  
Renk: Gri RAL7030  
80x60 Slotted Cable Trunking  
Complete with cover  
Packaging: 24m  
Color: Grey RAL 7030



607 80

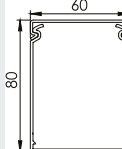

**60x80**

PVC Kablo Kanalı  
Kapaklı Satılır  
Ambalaj: 24m  
Renk: Gri RAL7030  
80x60 Slotted Cable Trunking  
Complete with cover  
Packaging: 24m  
Color: Grey RAL 7030



807 80

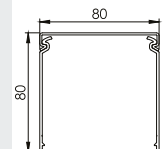

**80x80**

PVC Kablo Kanalı  
Kapaklı Satılır  
Ambalaj: 24m  
Renk: Gri RAL7030  
80x80 Slotted Cable Trunking  
Complete with cover  
Packaging: 24m  
Color: Grey RAL 7030

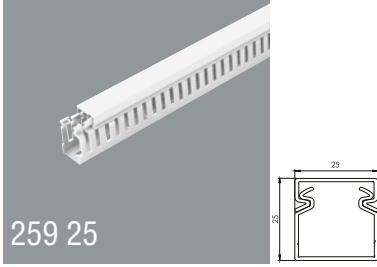
**DLX LINE DELİKLİ PANO KANALLARI**  
**DLX LINE SLOTTED CABLE TRUNKINGS****259 25****25x25**

PVC Kablo Kanalı  
Kapaklı Satılır  
Ambalaj: 100m  
Renk: Beyaz RAL9016  
25x25 Slotted Cable Trunking  
Complete with cover  
Packaging: 100m  
Color: White RAL 9016

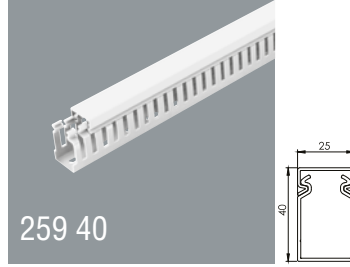
**259 40****25x40**

PVC Kablo Kanalı  
Kapaklı Satılır  
Ambalaj: 80m  
Renk: Beyaz RAL9016  
25x40 Slotted Cable Trunking  
Complete with cover  
Packaging: 80m  
Color: White RAL 9016

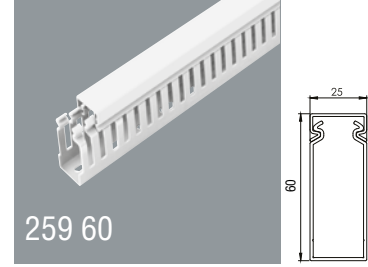
**259 60****25x60**

PVC Kablo Kanalı  
Kapaklı Satılır  
Ambalaj: 72m  
Renk: Beyaz RAL9016  
25x40 Slotted Cable Trunking  
Complete with cover  
Packaging: 72m  
Color: White RAL 9016

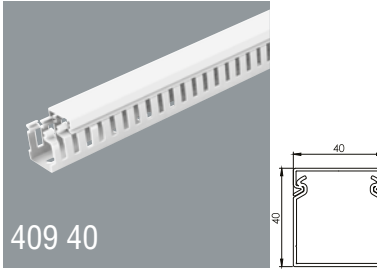
**409 40****40x40**

PVC Kablo Kanalı  
Kapaklı Satılır  
Ambalaj: 50m  
Renk: Beyaz RAL9016  
40x40 Slotted Cable Trunking  
Complete with cover  
Packaging: 50m  
Color: White RAL 9016

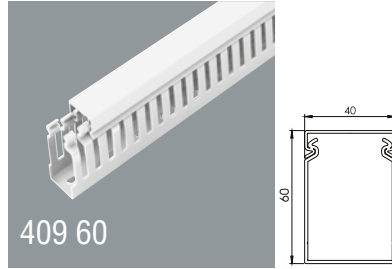
**409 60****40x60**

PVC Kablo Kanalı  
Kapaklı Satılır  
Ambalaj: 40m  
Renk: Beyaz RAL9016  
40x60 Slotted Cable Trunking  
Complete with cover  
Packaging: 40m  
Color: White RAL 9016

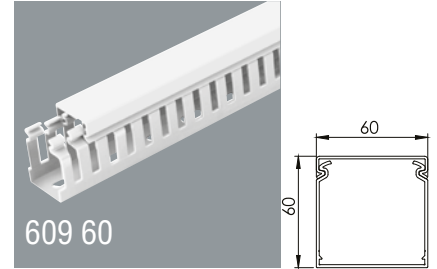
**609 60****60x60**

PVC Kablo Kanalı  
Kapaklı Satılır  
Ambalaj: 32m  
Renk: Beyaz RAL9016  
60x60 Slotted Cable Trunking  
Complete with cover  
Packaging: 32m  
Color: White RAL 9016

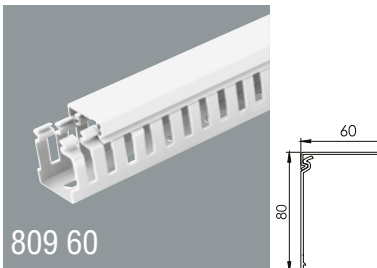
**809 60****80x60**

PVC Kablo Kanalı  
Kapaklı Satılır  
Ambalaj: 24m  
Renk: Beyaz RAL9016  
80x60 Slotted Cable Trunking  
Complete with cover  
Packaging: 24m  
Color: White RAL 9016

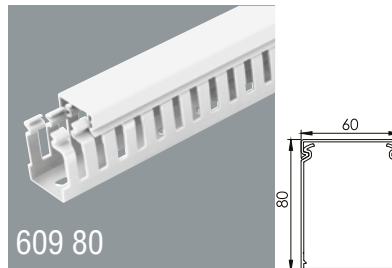
**609 80****60x80**

PVC Kablo Kanalı  
Kapaklı Satılır  
Ambalaj: 24m  
Renk: Beyaz RAL9016  
80x60 Slotted Cable Trunking  
Complete with cover  
Packaging: 24m  
Color: White RAL 9016

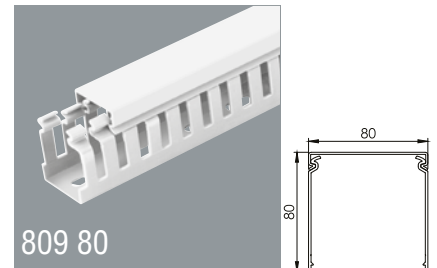
**809 80****80x80**

PVC Kablo Kanalı  
Kapaklı Satılır  
Ambalaj: 24m  
Renk: Beyaz RAL9016  
80x60 Slotted Cable Trunking  
Complete with cover  
Packaging: 24m  
Color: White RAL 9016

## HELEZON PANO SİRİLİ / HELICOID PANEL SPIRAL

### Helezon Pano Spirali 50cm / Helezon Pano Spirali 50cm

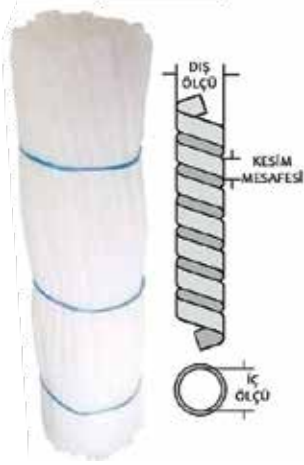

Kod Code	NO	Açıklama Description	İç Çap Inner Diameter	Dış Çap Out Diameter	Ambalaj Quantity
84006	1	6'lık Helezon Pano Spirali	5 mm	6 mm	100 Adet/Pcs
84008	2	8'lik Helezon Pano Spirali	7 mm	8 mm	100 Adet/Pcs
84011	3	11'lik Helezon Pano Spirali	9,5 mm	11 mm	100 Adet/Pcs
84014	4	14'lük Helezon Pano Spirali	12,5 mm	14 mm	50 Adet/Pcs
84017	5	17'lik Helezon Pano Spirali	15 mm	17 mm	50 Adet/Pcs



### Helezon Pano Spirali 10m / Helezon Pano Spirali 10mt.

Kod Code	NO	Açıklama Description	İç Çap Inner Diameter	Dış Çap Out Diameter	Ambalaj Quantity
86006	1	6'lık Helezon Pano Spirali	5 mm	6 mm	1000 mt.
86008	2	8'lik Helezon Pano Spirali	7 mm	8 mm	800 mt.
86011	3	11'lik Helezon Pano Spirali	9,5 mm	11 mm	500 mt.
86014	4	14'lük Helezon Pano Spirali	12,5 mm	14 mm	400 mt.
86017	5	17'lik Helezon Pano Spirali	15 mm	17 mm	250 mt.

**DLX**<sup>®</sup> **FIL**  
electric

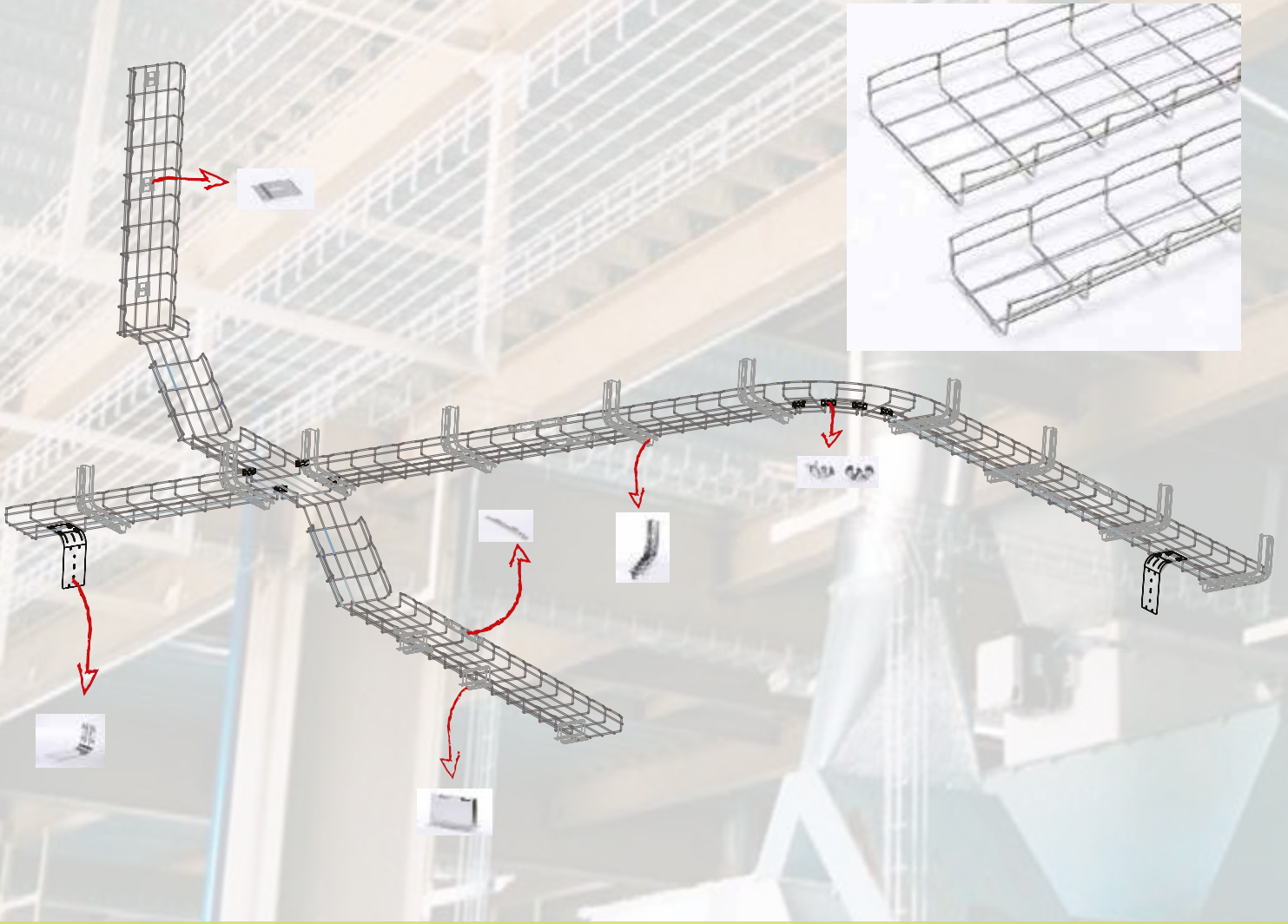

**D** DLXFIL TEL ÖRGÜ KABLO KANALLARI  
DLXFIL WIRE-MESH CABLE TRAYS

## DLXFİL DÜZ TEL ÖRGÜ KABLO KANALLARI / DLXFIL FLAT WIRE-MESH CABLE TRAYS

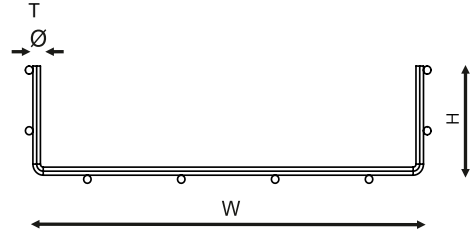

### DÜZ TEL ÖRGÜ KABLO KANALLARI (H 35) FLAT WIRE-MESH TRAYS (H 35)

Ref	W mm	H mm	T Ø mm
1 4050 035	50	35	4
1 4100 035	100	35	4
1 4150 035	150	35	4
1 4200 035	200	35	4
1 4300 035	300	35	4
1 4400 035	400	35	4
1 4500 035	500	35	4
1 4600 035	600	35	4

### DÜZ TEL ÖRGÜ KABLO KANALLARI (H 35) FLAT WIRE-MESH TRAYS (H 35)

Ref	W mm	H mm	T Ø mm
1 5050 035	50	35	5
1 5100 035	100	35	5
1 5150 035	150	35	5
1 5200 035	200	35	5
1 5300 035	300	35	5
1 5400 035	400	35	5
1 5500 035	500	35	5
1 5600 035	600	35	5

### DÜZ TEL ÖRGÜ KABLO KANALLARI (H 50) FLAT WIRE-MESH TRAYS (H 50)

Ref	W mm	H mm	T Ø mm
1 4050 050	50	50	4
1 4100 050	100	50	4
1 4150 050	150	50	4
1 4200 050	200	50	4
1 4300 050	300	50	4
1 4400 050	400	50	4
1 4500 050	500	50	4
1 4600 050	600	50	4

### DÜZ TEL ÖRGÜ KABLO KANALLARI (H 50) FLAT WIRE-MESH TRAYS (H 50)

Ref	W mm	H mm	T Ø mm
1 5050 050	50	50	5
1 5100 050	100	50	5
1 5150 050	150	50	5
1 5200 050	200	50	5
1 5300 050	300	50	5
1 5400 050	400	50	5
1 5500 050	500	50	5
1 5600 050	600	50	5

### MALZEME TİPİ / MATERIAL TYPE

304 KALİTE PASLANMAZ STAINLESS STEEL 304	316 KALİTE PASLANMAZ STAINLESS STEEL 316	SICAK DALDIRMA GALVANİZ HOT-DIP GALVANIZED	ELEKTRO GALVANİZ ELECTRO GALVANIZED
SS304	SS316	HDG	EG

- Tel kablo kanalı standart uzunluk 3000 mm'dir  
Wire-mesh cable trays standart length is 3000 mm
- Tel kablo kanalı bağlantısı için elemanı kullanılmalıdır  
Each wire-mesh cable trays needs straight connectors
- Lütfen siparişlerinizde ürün kodu ve kaplama şeklini belirtiniz  
Please indicate order code and the shape of coating in your orders

## DLXFİL DÜZ TEL ÖRGÜ KABLO KANALLARI / DLXFIL FLAT WIRE-MESH CABLE TRAYS

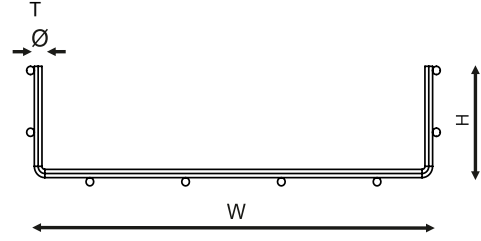

### DÜZ TEL ÖRGÜ KABLO KANALLARI (H 75) FLAT WIRE-MESH TRAYS (H 75)

Ref	W mm	H mm	T Ø mm
1 4100 075	100	75	4
1 4150 075	150	75	4
1 4200 075	200	75	4
1 4300 075	300	75	4
1 4400 075	400	75	4
1 4500 075	500	75	4
1 4600 075	600	75	4

### DÜZ TEL ÖRGÜ KABLO KANALLARI (H 75) FLAT WIRE-MESH TRAYS (H 75)

Ref	W mm	H mm	T Ø mm
1 5100 075	100	75	5
1 5150 075	150	75	5
1 5200 075	200	75	5
1 5300 075	300	75	5
1 5400 075	400	75	5
1 5500 075	500	75	5
1 5600 075	600	75	5

### DÜZ TEL ÖRGÜ KABLO KANALLARI (H 100) FLAT WIRE-MESH TRAYS (H 100)

Ref	W mm	H mm	T Ø mm
1 4100 100	100	100	4
1 4150 100	150	100	4
1 4200 100	200	100	4
1 4300 100	300	100	4
1 4400 100	400	100	4
1 4500 100	500	100	4
1 4600 100	600	100	4

### DÜZ TEL ÖRGÜ KABLO KANALLARI (H 100) FLAT WIRE-MESH TRAYS (H 100)

Ref	W mm	H mm	T Ø mm
1 5100 100	100	100	5
1 5150 100	150	100	5
1 5200 100	200	100	5
1 5300 100	300	100	5
1 5400 100	400	100	5
1 5500 100	500	100	5
1 5600 100	600	100	5

### MALZEME TİPİ / MATERIAL TYPE

304 KALİTE PASLANMAZ STAINLESS STEEL 304	316 KALİTE PASLANMAZ STAINLESS STEEL 316	SICAK DALDIRMA GALVANİZ HOT-DIP GALVANIZED	ELEKTRO GALVANİZ ELECTRO GALVANIZED
SS304	SS316	HDG	EG

- Tel kablo kanalı standart uzunluk 3000 mm'dir  
Wire-mesh cable trays standart length is 3000 mm
- Tel kablo kanalı bağlantısı için elemanı kullanılmalıdır  
Each wire-mesh cable trays needs straight connectors
- Lütfen siparişlerinizde ürün kodu ve kaplama şeklini belirtiniz  
Please indicate order code and the shape of coating in your orders

## DLXFİL KIVRIMLI TEL ÖRGÜ KABLO KANALLARI / DLXFIL CURVED WIRE-MESH CABLE TRAYS

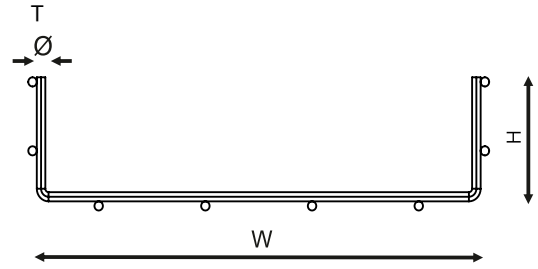
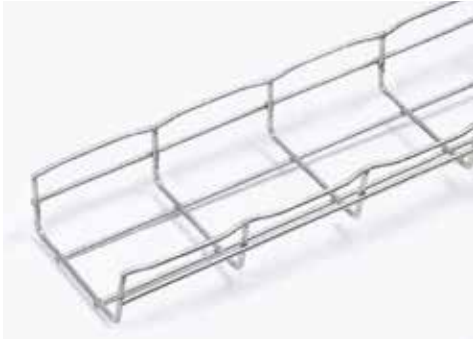

KIVRIMLI TEL ÖRGÜ KABLO KANALLARI (H 40)  
CURVED WIRE-MESH CABLE TRAYS (H 40)

Ref	W mm	H mm	T Ø mm
2 4050 040	50	40	4
2 4100 040	100	40	4
2 4150 040	150	40	4
2 4200 040	200	40	4
2 4300 040	300	40	4
2 4400 040	400	40	4
2 4500 040	500	40	4
2 4600 040	600	40	4

KIVRIMLI TEL ÖRGÜ KABLO KANALLARI (H 40)  
CURVED WIRE-MESH CABLE TRAYS (H 40)

Ref	W mm	H mm	T Ø mm
2 5050 040	50	40	5
2 5100 040	100	40	5
2 5150 040	150	40	5
2 5200 040	200	40	5
2 5300 040	300	40	5
2 5400 040	400	40	5
2 5500 040	500	40	5
2 5600 040	600	40	5

KIVRIMLI TEL ÖRGÜ KABLO KANALLARI (H 55)  
CURVED WIRE-MESH CABLE TRAYS (H 55)

Ref	W mm	H mm	T Ø mm
2 4050 055	50	55	4
2 4100 055	100	55	4
2 4150 055	150	55	4
2 4200 055	200	55	4
2 4300 055	300	55	4
2 4400 055	400	55	4
2 4500 055	500	55	4
2 4600 055	600	55	4

KIVRIMLI TEL ÖRGÜ KABLO KANALLARI (H 55)  
CURVED WIRE-MESH CABLE TRAYS (H 55)

Ref	W mm	H mm	T Ø mm
2 5050 055	50	55	5
2 5100 055	100	55	5
2 5150 055	150	55	5
2 5200 055	200	55	5
2 5300 055	300	55	5
2 5400 055	400	55	5
2 5500 055	500	55	5
2 5600 055	600	55	5

### MALZEME TİPİ / MATERIAL TYPE

304 KALİTE PASLANMAZ STAINLESS STEEL 304	316 KALİTE PASLANMAZ STAINLESS STEEL 316	SICAK DALDIRMA GALVANİZ HOT-DIP GALVANIZED	ELEKTRO GALVANİZ ELECTRO GALVANIZED
SS304	SS316	HDG	EG

- Tel kablo kanalı standart uzunluk 3000 mm'dir  
Wire-mesh cable trays standart length is 3000 mm
- Tel kablo kanalı bağlantısı için elemanı kullanılmalıdır  
Each wire-mesh cable trays needs straight connectors
- Lütfen siparişlerinizde ürün kodu ve kaplama şeklini belirtiniz  
Please indicate order code and the shape of coating in your orders

DLXFİL KIVRIMLI TEL ÖRGÜ KABLO KANALLARI / DLXFIL CURVED WIRE-MESH CABLE TRAYS

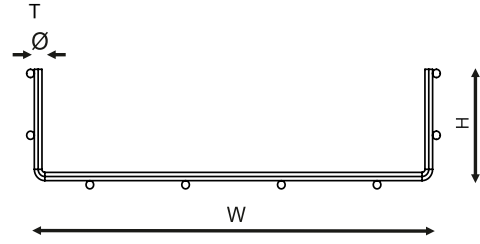
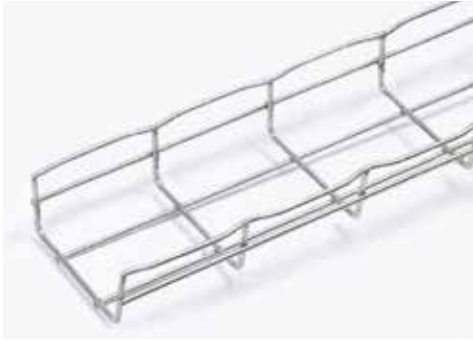

KIVRIMLI TEL ÖRGÜ KABLO KANALLARI (H 80)  
CURVED WIRE-MESH CABLE TRAYS (H 80)

Ref	W mm	H mm	T Ø mm
2 4100 080	100	80	4
2 4150 080	150	80	4
2 4200 080	200	80	4
2 4300 080	300	80	4
2 4400 080	400	80	4
2 4500 080	500	80	4
2 4600 080	600	80	4

KIVRIMLI TEL ÖRGÜ KABLO KANALLARI (H 80)  
CURVED WIRE-MESH CABLE TRAYS (H 80)

Ref	W mm	H mm	T Ø mm
2 5100 080	100	80	5
2 5150 080	150	80	5
2 5200 080	200	80	5
2 5300 080	300	80	5
2 5400 080	400	80	5
2 5500 080	500	80	5
2 5600 080	600	80	5

KIVRIMLI TEL ÖRGÜ KABLO KANALLARI (H 105)  
CURVED WIRE-MESH CABLE TRAYS (H 105)

Ref	W mm	H mm	T Ø mm
2 4100 105	100	105	4
2 4150 105	150	105	4
2 4200 105	200	105	4
2 4300 105	300	105	4
2 4400 105	400	105	4
2 4500 105	500	105	4
2 4600 105	600	105	4

KIVRIMLI TEL ÖRGÜ KABLO KANALLARI (H 105)  
CURVED WIRE-MESH CABLE TRAYS (H 105)

Ref	W mm	H mm	T Ø mm
2 5100 105	100	105	5
2 5150 105	150	105	5
2 5200 105	200	105	5
2 5300 105	300	105	5
2 5400 105	400	105	5
2 5500 105	500	105	5
2 5600 105	600	105	5

MALZEME TİPİ / MATERIAL TYPE

304 KALİTE PASLANMAZ STAINLESS STEEL 304	316 KALİTE PASLANMAZ STAINLESS STEEL 316	SICAK DALDIRMA GALVANİZ HOT-DIP GALVANIZED	ELEKTRO GALVANİZ ELECTRO GALVANIZED
SS304	SS316	HDG	EG

- Tel kablo kanalı standart uzunluk 3000 mm'dir  
Wire-mesh cable trays standart length is 3000 mm
- Tel kablo kanalı bağlantısı için elemanı kullanılmalıdır  
Each wire-mesh cable trays needs straight connectors
- Lütfen siparişlerinizde ürün kodu ve kaplama şeklini belirtiniz  
Please indicate order code and the shape of coating in your orders



DLXFİL TEL ÖRGÜ KABLO KANAL AKSESUARLARI  
DLXFIL WIRE-MESH CABLE TRAYS ACCESSORY LINE

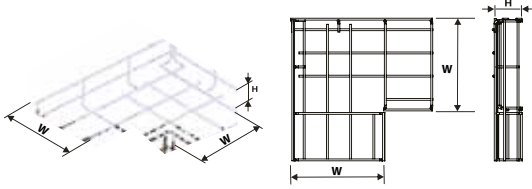

90° DÖNÜŞ ELAMANI (H: 50)  
HORIZONTAL BENDS 90° (H: 50)

Ref	W (mm)	H (mm)	T Ø (mm)
1 4050 053	50	50	4
1 4100 053	100	50	4
1 4200 053	200	50	4
1 4300 053	300	50	4
1 4400 053	400	50	4
1 4500 053	500	50	4
1 4600 053	600	50	4

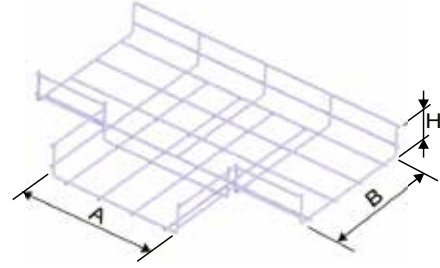

T DÖNÜŞ ELAMANI (H: 50)  
HORIZONTAL TEES (H: 50)

Ref	W (mm)	H (mm)	T Ø (mm)
1 4050 054	50	50	4
1 4100 054	100	50	4
1 4200 054	200	50	4
1 4300 054	300	50	4
1 4400 054	400	50	4
1 4500 054	500	50	4
1 4600 054	600	50	4

90° DÖNÜŞ ELAMANI (H: 50)  
HORIZONTAL BENDS 90° (H: 50)

Ref	W (mm)	H (mm)	T Ø (mm)
1 5050 053	50	50	5
1 5100 053	100	50	5
1 5200 053	200	50	5
1 5300 053	300	50	5
1 5400 053	400	50	5
1 5500 053	500	50	5
1 5600 053	600	50	5

T DÖNÜŞ ELAMANI (H: 50)  
HORIZONTAL TEES (H: 50)

Ref	W (mm)	H (mm)	T Ø (mm)
1 5050 054	50	50	5
1 5100 054	100	50	5
1 5200 054	200	50	5
1 5300 054	300	50	5
1 5400 054	400	50	5
1 5500 054	500	50	5
1 5600 054	600	50	5

90° DÖNÜŞ ELAMANI (H: 100)  
HORIZONTAL BENDS 90° (H: 100)

Ref	W (mm)	H (mm)	T Ø (mm)
1 5050 103	50	100	4
1 5100 103	100	100	4
1 5200 103	200	100	4
1 5300 103	300	100	4
1 5400 103	400	100	4
1 5500 103	500	100	4
1 5600 103	600	100	4

T DÖNÜŞ ELAMANI (H: 100)  
HORIZONTAL TEES (H: 100)

Ref	W (mm)	H (mm)	T Ø (mm)
1 5050 104	50	100	4
1 5100 104	100	100	4
1 5200 104	200	100	4
1 5300 104	300	100	4
1 5400 104	400	100	4
1 5500 104	500	100	4
1 5600 104	600	100	4

90° DÖNÜŞ ELAMANI (H: 100)  
HORIZONTAL BENDS 90° (H: 100)

Ref	W (mm)	H (mm)	T Ø (mm)
1 5050 100	50	100	5
1 5100 100	100	100	5
1 5200 100	200	100	5
1 5300 100	300	100	5
1 5400 100	400	100	5
1 5500 100	500	100	5
1 5600 100	600	100	5

T DÖNÜŞ ELAMANI (H: 100)  
HORIZONTAL TEES (H: 100)

Ref	W (mm)	H (mm)	T Ø (mm)
1 5050 103	50	100	5
1 5100 103	100	100	5
1 5200 103	200	100	5
1 5300 103	300	100	5
1 5400 103	400	100	5
1 5500 103	500	100	5
1 5600 103	600	100	5

DLXFİL TEL ÖRGÜ KABLO KANAL AKSESUARLARI  
DLXFIL WIRE-MESH CABLE TRAYS ACCESSORY LINE

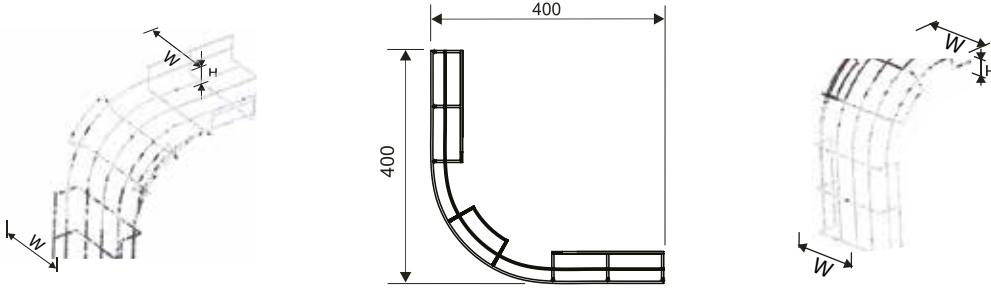

DIŞ BÜKEY DÖNÜŞ ELAMANI (H: 50)  
OUTSIDE BENDS (H: 50)

Ref	W (mm)	H (mm)	T Ø (mm)
1 4050 052	50	50	4
1 4100 052	100	50	4
1 4200 052	200	50	4
1 4300 052	300	50	4
1 4400 052	400	50	4
1 4500 052	500	50	4
1 4600 052	600	50	4

İÇ BÜKEY DÖNÜŞ ELAMANI (H: 50)  
INSIDE BENDS (H: 50)

Ref	W (mm)	H (mm)	T Ø (mm)
1 4050 051	50	50	4
1 4100 051	100	50	4
1 4200 051	200	50	4
1 4300 051	300	50	4
1 4400 051	400	50	4
1 4500 051	500	50	4
1 4600 051	600	50	4

DIŞ BÜKEY DÖNÜŞ ELAMANI (H: 50)  
OUTSIDE BENDS (H: 50)

Ref	W (mm)	H (mm)	T Ø (mm)
1 5050 052	50	50	5
1 5100 052	100	50	5
1 5200 052	200	50	5
1 5300 052	300	50	5
1 5400 052	400	50	5
1 5500 052	500	50	5
1 5600 052	600	50	5

İÇ BÜKEY DÖNÜŞ ELAMANI (H: 50)  
INSIDE BENDS (H: 50)

Ref	W (mm)	H (mm)	T Ø (mm)
1 5050 051	50	50	5
1 5100 051	100	50	5
1 5200 051	200	50	5
1 5300 051	300	50	5
1 5400 051	400	50	5
1 5500 051	500	50	5
1 5600 051	600	50	5

DIŞ BÜKEY DÖNÜŞ ELAMANI (H: 100)  
OUTSIDE BENDS (H: 100)

Ref	W (mm)	H (mm)	T Ø (mm)
1 4050 102	50	100	4
1 4100 102	100	100	4
1 4200 102	200	100	4
1 4300 102	300	100	4
1 4400 102	400	100	4
1 4500 102	500	100	4
1 4600 102	600	100	4

İÇ BÜKEY DÖNÜŞ ELAMANI (H: 100)  
INSIDE BENDS (H: 100)

Ref	W (mm)	H (mm)	T Ø (mm)
1 4050 101	50	100	4
1 4100 101	100	100	4
1 4200 101	200	100	4
1 4300 101	300	100	4
1 4400 101	400	100	4
1 4500 101	500	100	4
1 4600 101	600	100	4

DIŞ BÜKEY DÖNÜŞ ELAMANI (H: 100)  
OUTSIDE BENDS (H: 100)

Ref	W (mm)	H (mm)	T Ø (mm)
1 5050 102	50	100	5
1 5100 102	100	100	5
1 5200 102	200	100	5
1 5300 102	300	100	5
1 5400 102	400	100	5
1 5500 102	500	100	5
1 5600 102	600	100	5

İÇ BÜKEY DÖNÜŞ ELAMANI (H: 100)  
INSIDE BENDS (H: 100)

Ref	W (mm)	H (mm)	T Ø (mm)
1 5050 101	50	100	5
1 5100 101	100	100	5
1 5200 101	200	100	5
1 5300 101	300	100	5
1 5400 101	400	100	5
1 5500 101	500	100	5
1 5600 101	600	100	5

DLXFİL TEL ÖRGÜ KABLO KANAL AKSESUARLARI  
DLXFIL WIRE-MESH CABLE TRAYS ACCESSORY LINE

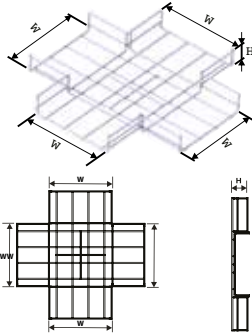

DÖRTLÜ DÖNÜŞ ELAMANI (H: 50)  
HORIZONTAL CROSSING BENDS (H: 50)

Ref	W (mm)	H (mm)	T Ø (mm)
1 4050 055	50	50	4
1 4100 055	100	50	4
1 4200 055	200	50	4
1 4300 055	300	50	4
1 4400 055	400	50	4
1 4500 055	500	50	4
1 4600 055	600	50	4

DÖRTLÜ DÖNÜŞ ELAMANI (H: 50)  
HORIZONTAL CROSSING BENDS (H: 50)

Ref	W (mm)	H (mm)	T Ø (mm)
1 5050 055	50	50	5
1 5100 055	100	50	5
1 5200 055	200	50	5
1 5300 055	300	50	5
1 5400 055	400	50	5
1 5500 055	500	50	5
1 5600 055	600	50	5

DÖRTLÜ DÖNÜŞ ELAMANI (H: 100)  
HORIZONTAL CROSSING BENDS (H: 100)

Ref	W (mm)	H (mm)	T Ø (mm)
1 4050 105	50	100	4
1 4100 105	100	100	4
1 4200 105	200	100	4
1 4300 105	300	100	4
1 4400 105	400	100	4
1 4500 105	500	100	4
1 4600 105	600	100	4

DÖRTLÜ DÖNÜŞ ELAMANI (H: 100)  
HORIZONTAL CROSSING BENDS (H: 100)

Ref	W (mm)	H (mm)	T Ø (mm)
1 5050 105	50	100	5
1 5100 105	100	100	5
1 5200 105	200	100	5
1 5300 105	300	100	5
1 5400 105	400	100	5
1 5500 105	500	100	5
1 5600 105	600	100	5



TEL KABLO KANILI 90°  
YATAY DÖNÜŞ ELEMANI  
WIRE-MESH CABLE TRAY  
HORIZONTAL BENDS 90°  
(H: 35 - 55 - 75 - 100)

Ref	W (mm)	H (mm)	T Ø (mm)
1 4050 356	50	35	4
1 4100 356	100	35	4
1 4200 356	200	35	4
1 4300 356	300	35	4
1 4400 356	400	35	4
1 4500 356	500	35	4
1 4600 356	600	35	4
1 5300 356	300	35	5
1 5400 356	400	35	5
1 5500 356	500	35	5
1 5600 356	600	35	5
2 4050 556	50	55	4
2 4100 556	100	55	4
2 4200 556	200	55	4
2 4300 556	300	55	4
2 4400 556	400	55	4
2 4500 556	500	55	4
2 4600 556	600	55	4
2 5300 556	300	55	5
2 5400 556	400	55	5
2 5500 556	500	55	5
2 5600 556	600	55	5
1 4100 756	100	75	4
1 4200 756	200	75	4
1 4300 756	300	75	4
1 4400 756	400	75	4
1 4500 756	500	75	4
1 4600 756	600	75	4
1 5300 756	300	75	5
1 5400 756	400	75	5
1 5500 756	500	75	5
1 5600 756	600	75	5
1 4100 106	100	100	4
1 4200 106	200	100	4
1 4300 106	300	100	4
1 4400 106	400	100	4
1 4500 106	500	100	4
1 4600 106	600	100	4
1 5300 106	300	100	5
1 5400 106	400	100	5
1 5500 106	500	100	5
1 5600 106	600	100	5

DLXFİL TEL ÖRGÜ KABLO KANAL AKSESUARLARI  
DLXFIL WIRE-MESH CABLE TRAYS ACCESSORY LINE

TEL ÖRGÜ KABLO KANAL KAPAĞI / WIRE-MESH CABLE TRAYS COVER

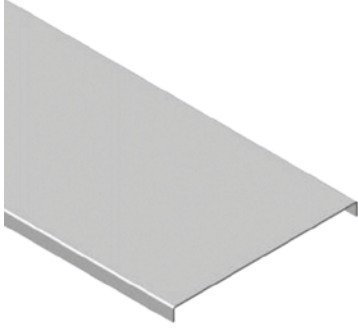

Ref	W (mm)	H (mm)	T Ø (mm)
1 1100 10	100	10	1,5
1 1200 10	200	10	1,5
1 1300 10	300	10	1,5
1 1400 10	400	10	1,5
1 1500 10	500	10	1,5
1 1600 10	600	10	1,5

TEL KABLO KANAL TAŞIYICISI / WIRE-MESH CABLE TRAY WALL SUPPORT

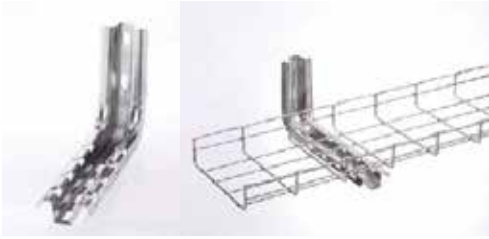

Ref.	W (mm)	304 KALİTE PASLANMAZ STAINLESS STEEL 304	SICAK DALDIRMA GALVANİZ HOT-DIP GALVANIZED	ELEKTRO GALVANİZ ELECTRO GALVANIZED
1 1050 20	50	SS304	HDG	EG
1 1100 20	100	SS304	HDG	EG
1 1200 20	200	SS304	HDG	EG
1 1300 20	300	SS304	HDG	EG
1 1400 20	400	SS304	HDG	EG
1 1500 20	500	SS304	HDG	EG
1 1600 20	600	SS304	HDG	EG

TEL ÖRGÜ KABLO KANAL DÖNÜŞ KİLİDİ / WIRE-MESH BENDING LOCKING PIECE



Ref.	304 KALİTE PASLANMAZ STAINLESS STEEL 304	SICAK DALDIRMA GALVANİZ HOT-DIP GALVANIZED	ELEKTRO GALVANİZ ELECTRO GALVANIZED
1 1050 30	SS304	HDG	EG
1 1100 30	SS304	HDG	EG

TEL ÖRGÜ KABLO KANAL YER BAĞLANTISI  
WIRE-MESH WIRE-MESH CABLE TRAYS FLOOR SUPPORT



Ref.	304 KALİTE PASLANMAZ STAINLESS STEEL 304	SICAK DALDIRMA GALVANİZ HOT-DIP GALVANIZED	ELEKTRO GALVANİZ ELECTRO GALVANIZED
1 1050 40	HDG	EG	EG

DLXFİL TEL ÖRGÜ KABLO KANAL AKSESUARLARI  
DLXFIL WIRE-MESH CABLE TRAYS ACCESSORY LINE

TEL ÖRGÜ KABLO KANAL KİLİDİ / WIRE-MESH CABLE TRAYS LOCKING PIECE



Ref.	304 KALİTE PASLANMAZ STAINLESS STEEL 304	SICAK DALDIRMA GALVANİZ HOT-DIP GALVANIZED	ELEKTRO GALVANİZ ELECTRO GALVANIZED
1 1050 50	SS304	HDG	EG

TEL ÖRGÜ KABLO KANAL EK ELAMAN / WIRE-MESH CABLE TRAYS JUNCTION PIECE

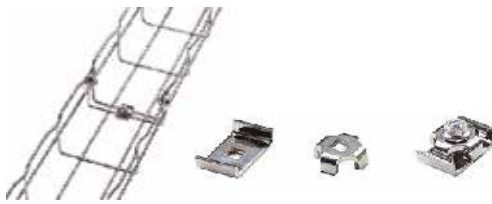

Ref.	304 KALİTE PASLANMAZ STAINLESS STEEL 304	SICAK DALDIRMA GALVANİZ HOT-DIP GALVANIZED	ELEKTRO GALVANİZ ELECTRO GALVANIZED
1 1050 60	SS304	HDG	EG

TEL ÖRGÜ KABLO KANAL GEÇİŞ SACI  
WIRE-MESH CABLE TRAYS OUTLET PROTECTION FOR CABLES



Ref.	304 KALİTE PASLANMAZ STAINLESS STEEL 304	SICAK DALDIRMA GALVANİZ HOT-DIP GALVANIZED	ELEKTRO GALVANİZ ELECTRO GALVANIZED
1 1050 70	SS304	HDG	EG

TEL ÖRGÜ KABLO KANAL TAŞIYICI BAĞLANTI ELEMANI  
WIRE-MESH CABLE TRAYS CENTRAL HANGING PLATE



Ref.	304 KALİTE PASLANMAZ STAINLESS STEEL 304	SICAK DALDIRMA GALVANİZ HOT-DIP GALVANIZED	ELEKTRO GALVANİZ ELECTRO GALVANIZED
1 1050 80	SS304	HDG	EG

TEL ÖRGÜ KABLO KANAL KİLİDİ MONTAJ APARATI  
WIRE-MESH CABLE TRAYS



Ref.	304 KALİTE PASLANMAZ STAINLESS STEEL 304	SICAK DALDIRMA GALVANİZ HOT-DIP GALVANIZED	ELEKTRO GALVANİZ ELECTRO GALVANIZED
1 1050 90	SS304	HDG	EG



Ş

EBEKE, UPS, DATA & TELEFON PRİZLERİ  
UPS, ENERGY, DATA & TELEPHONE SOCKETS

## ŞEBEKE, UPS, DATA & TELEFON PRİZLERİ ENERGY, UPS, DATA & TELEPHONE SOCKETS



**245 45 45x45**  
45x45 Topraklı Priz (2 Modül)  
45x45 Grounded Socket (2 Module)  
Ambalaj: 20 Adet / Packaging: 20 pcs  
Renk RAL 9010-9016 Beyaz  
White Ral 9010-9016 Color  
Çocuk Korumalı / Built in Baby Protection  
45° Açılı Priz Yuvası / 45° Socket Hole



**245 46 45x45**  
45x45 Topraklı Priz (2 Modül)  
45x45 Grounded Socket (2 Module)  
Ambalaj: 20 adet / Packaging: 20 pcs  
Renk RAL 3020 Kırmızı  
Ral 3020 Red Color  
Çocuk Korumalı / Built in Baby Protection  
45° Açılı Priz Yuvası / 45° Socket Hole



**245 42 45x45**  
45x45 Topraklı Priz (2 Modül)  
45x45 Grounded Socket (2 Module)  
Ambalaj: 20 Adet / Packaging: 20 pcs  
Renk RAL 9006 Yeşil  
Green Ral 9006 Color  
Çocuk Korumalı / Built in Baby Protection  
45° Açılı Priz Yuvası / 45° Socket Hole

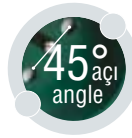

**245 47 Priz Birleştirme Barası**  
Socket junction Bar  
Ambalaj: 50 adet  
Packaging: 50 pcs

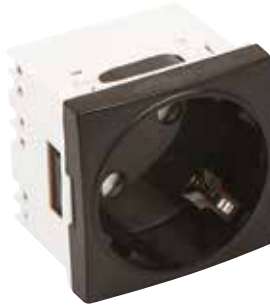

**245 43 45x45**  
45x45 Topraklı Priz (2 Modül)  
45x45 Grounded Socket (2 Module)  
Ambalaj: 20 adet / Packaging: 20 pcs  
Renk RAL 9005 Siyah  
Ral 9005 Black Color  
Çocuk Korumalı / Built in Baby Protection  
45° Açılı Priz Yuvası / 45° Socket Hole



## TEKNİK ÖZELLİKLER / TECHNICAL SPECIFICATIONS

45x45mm formatındadır.  
Kolay kablo bağlantı baralarına sahiptir.  
Kontakt girifleri 2.5 mm<sup>2</sup> kesitindeki kabloları uygundur.  
(Tek damar ve çok telli kablo girifl yerine uygundur.)  
Şebeke prizi renk RAL 9010 Beyaz'dır.  
UPS Priz renk RAL 3020 kırmızıdır.  
Köprü bağlantısına ihtiyaç yoktur.  
Hızlı montaj imkanına sahiptir.  
Çocuk korumalıdır.  
45° açılı fiş yuvasına sahiptir.

45x45mm dimensions.  
Practical and easy cable connection systems.  
Contact entrance is available for cable cross section of 2.5 mm<sup>2</sup>.  
(Suitable for entrance of solid wire and stranded wire.)  
Grounded Socket Ral 9010 White.  
UPS Socket White Ral 3020 Red  
No need for bridge connection  
Quick installation.  
Built in Baby Protection  
45° angled plug slot.

DLX SİSTEM KABLO KANALLARI İÇİN 2-4-6-8 MODÜL ÇOKLU PRİZLER  
2-4-6-8 MODULES OF SOCKETS/MULTIPLE SOCKETS FOR CABLE TRUNKING



**245 46**  
TEKLİ UPS PRİZ  
SINGLE UPS SOCKET



**245 45**  
TEKLİ fiBEKE PRİZ  
SINGLE GROUNDED SOCKET



**245 86**  
2'Lİ UPS PRİZ  
DOUBLE UPS SOCKET



**245 85**  
2'Lİ fiBEKE PRİZ  
DOUBLE GROUNDED SOCKET



**245 88**  
3'LÜ UPS PRİZ  
TRIPLE UPS SOCKET



**245 87**  
3'LÜ fiBEKE PRİZ  
TRIPLE GROUNDED SOCKET











**245 90**  
4'LÜ UPS PRİZ  
QUADRUPLE UPS SOCKET



**245 89**  
4'LÜ fiBEKE PRİZ  
QUADRUPLE GROUNDED SOCKET



**DLX SİSTEM KABLO KANALLARI İÇİN 2-4-6-8 MODÜL ÇOKLU PRİZLER**  
**2-4-6-8 MODULES OF SOCKETS/MULTIPLE SOCKETS FOR CABLE TRUNKING**

	AÇIKLAMA Description	Ref	RENK Colour	MODÜL Module	AMBALAJ Packaging
	16 A 250 V AC 2P +T	245 45	BEYAZ WHITE	2	20
	16 A 250 V AC 2 X 2P+T	245 85	BEYAZ WHITE	4	10
	16 A 250 V AC 3 X 2P+T	245 87	BEYAZ WHITE	6	16
	16 A 250 V AC 4 X 2P+T	245 89	BEYAZ WHITE	8	12
	16 A 250 V AC 2P +T	245 46	KIRMIZI RED	2	20
	16 A 250 V AC 2 X 2P+T	245 86	KIRMIZI RED	4	10
	16 A 250 V AC 3 X 2P+T	245 88	KIRMIZI RED	6	16
	16 A 250 V AC 4 X 2P+T	245 90	KIRMIZI RED	8	12

**ŞEBEKE VE UPS PRİZLERİ**  
**ENERGY & UPS SOCKETS****245 45EC 45x45**

45x45 Topraklı Priz (2 Modül)  
45x45 Grounded Socket (2 Module)  
Ambalaj: 20 Adet / Packaging: 20 pcs  
Renk RAL 9010-9016 Beyaz  
White Ral 9010-9016 Color  
Çocuk Korumalı / Built in Baby Protection

**245 46EC 45x45**

45x45 Topraklı Priz (2 Modül)  
45x45 Grounded Socket (2 Module)  
Ambalaj: 20 adet / Packaging: 20 pcs  
Renk RAL 3020 Kırmızı  
Ral 3020 Red Color  
Çocuk Korumalı / Built in Baby Protection

ŞEBEKE, UPS, DATA & TELEFON PRİZLERİ  
ENERGY, UPS, DATA & TELEPHONE SOCKETS



245 44

**45x45 İngiliz Tipi Priz**  
45x45 British Type Socket  
Ambalaj: 1 adet  
Packaging: 1 pcs



245 05

**45x45 Üniversal Tip Priz**  
45x45 Universal Type Socket  
Ambalaj: 1 adet /  
Packaging: 1 pcs



245 49

**45x45**  
Data Telefon Priz Kapağı Eko  
(2 Modül)  
Ambalaj: 1 adet / Packaging: 1 pcs  
Keystone Jack For Data-Telephone  
Eco (2 Module)  
Toz Korumalı / Dust Protected



245 50

**45x22.5**  
Data Telefon Priz Kapağı Eko  
(1 Modül)  
Ambalaj: 1 adet / Packaging: 1 pcs  
Keystone Jack For Data-Telephone  
Eco (1 Module)  
Toz Korumalı / Dust Protected



245 07

**45x45**  
Data Telefon Priz Kapağı Etiketli  
(2 Modül / 2 Port)  
Ambalaj: 1 adet / Packaging: 1 pcs  
Keystone Jack For Data-Telephone  
With label (2 Module)  
Toz Korumalı / Dust Protected



245 08

**45x45**  
Data Telefon Priz Kapağı Etiketli  
(2 Modül / 2 Port)  
Ambalaj: 1 adet / Packaging: 1 pcs  
Keystone Jack For Data-Telephone  
(2 Module)  
Toz Korumalı / Dust Protected



245 09

**45x22.5**  
Data Telefon Priz Kapağı Etiketli  
(1 Modül)  
Ambalaj: 1 adet / Packaging: 1 pcs  
Keystone Jack For Data-Telephone  
(1 Module)  
Toz Korumalı / Dust Protected



245 66

**45x22.5 Anahtar**  
45x22.5 Switch  
Ambalaj: 1 adet / Packaging: 1 pcs



245 67

**CAT 3 Plug**  
CAT 3 Plug  
Ambalaj: 100 adet  
Packaging: 100 pcs



245 69

**CAT6 Plug**  
CAT 6 Plug  
Ambalaj: 100 adet  
Packaging: 100 pcs



245 52

**CAT 3 Telefon Konnektörü**  
CAT 3 Keystone Jack For Telephone  
Ambalaj: 1 adet / Packaging: 1 pcs  
RJ 11-12 (1 Modül) / RJ 11-12 (2 Module)



245 53

**CAT 5 Data Konnektörü**  
CAT 5 Keystone Jack For Data  
Ambalaj: 1 adet / Packaging: 1 pcs  
RJ 45 (1 Modül) / RJ 45 (2 Module)



245 54

**CAT 6 Data Konnektörü**  
CAT 6 Keystone Jack For Data  
Ambalaj: 1 adet / Packaging: 1 pcs  
RJ 45 (1 Modül) / RJ 45 (2 Module)



250 10 250 11

**45x45 45x22,5**  
Data Telefon Priz Kapağı  
Etiketli - Camlı  
Keystone Jack For Data-Telephone  
White Label and Transparent Window  
Ambalaj: 1 adet / Packaging: 1 pcs

**ŞEBEKE, UPS, DATA & TELEFON PRİZLERİ**  
**ENERGY, UPS, DATA & TELEPHONE SOCKETS**

245 51

**45x22.5**Boşluk Kapama (1 Modül)  
Blind cover (1 Module)  
Ambalaj: 1 adet / Packaging: 1 pcs

245 48

**45x45**Boşluk Kapama (2 Modül)  
Blind cover (2 Module)  
Ambalaj: 1 adet / Packaging: 1 pcs

245 56

**45x45 F Tipi Tv Prizi**45x45 F-type TV socket  
Ambalaj: 1 adet / Packaging: 1 pcs

245 57

**45x45 WGA Priz  
Konnektörü**45x45 WGA Socket Connector  
Ambalaj: 1 adet / Packaging: 1 pcs

245 62

**45x22.5 USB**45x22.5 USB  
Ambalaj: 1 adet / Packaging: 1 pcs

245 63

**45x22.5 HDMI**45x22.5 HDMI  
Ambalaj: 1 adet / Packaging: 1 pcs

245 30

**USB Type C + A Şarj**USB Type C + A Charger  
Ambalaj: 1 adet / Packaging: 1 pcs  
20W

245 91

**45x22.5 Ses & Video**45x22.5 Audio & Video  
Ambalaj: 1 adet  
Packaging: 1 pcs

245 01

**2 Portlu Type-C Şarj**Type-C Charger 2 Port  
Ambalaj: 1 adet / Packaging: 1 pcs  
2100 ma

245 02

**USB Type C + A Şarj**USB Type C + A Charger  
Ambalaj: 1 adet / Packaging: 1 pcs  
2100 ma

245 06

**HDMI Dişi 90° Açılı  
Vidalı Adaptör**HDMI 90° Degr Whit Screw Adaptor  
Ambalaj: 1 adet / Packaging: 1 pcs

250 07

**45x22,5 HDMI  
Priz Kapağı**45x22,5 HDMI face Plate  
Ambalaj: 1 adet / Packaging: 1 pcs

250 08

**USB Dişi 90° Açılı  
Vidalı Adaptör**USB 90° Degr Whit Screw Adaptor  
Ambalaj: 1 adet / Packaging: 1 pcs

250 09

**45x22,5 USB  
Priz Kapağı**45x22,5 USB face Plate  
Ambalaj: 1 adet / Packaging: 1 pcs

245 10

**HDMI Kablosu  
Dişi, Dişi 30 cm.**HDMI Cable 30 cm.  
Ambalaj: 1 adet / Packaging: 1 pcs

245 11

**USB Kablosu  
Dişi, Dişi 30 cm.**USB Cable 30 cm.  
Ambalaj: 1 adet / Packaging: 1 pcs

FİBER OPTİK AKSESUARLARI  
FIBER OPTIC ACCESSORY



245 12

**Fiber Ek Kaset Standart**  
Fiber Optic Cassettes  
Ambalaj: 1 adet  
Packaging: 1 pcs



245 13

**Fiber Ek Kaset Mini**  
Fiber Optic Cassettes Mini  
Ambalaj: 1 adet  
Packaging: 1 pcs



245 14

**Fiber Ek Kaset Camlı**  
Fiber Optic Cassettes  
Transparent Cover  
Ambalaj: 1 adet  
Packaging: 1 pcs



250 01

**45x22,5 / LC-SC  
Fiber Face Plate**  
Ambalaj: 1 adet  
Packaging: 1 pcs



250 02

**45x45 / 2 X LC  
Doublex Face Plate**  
Ambalaj: 1 adet  
Packaging: 1 pcs



250 03

**45x45 / LC  
Doublex Face Plate**  
Ambalaj: 1 adet  
Packaging: 1 pcs



250 04

**45x45 / 2 X SC  
Doublex Face Plate**  
Ambalaj: 1 adet  
Packaging: 1 pcs



250 05

**45x45 / SC  
Doublex Face Plate**  
Ambalaj: 1 adet  
Packaging: 1 pcs



250 06

**45x45 / 2 X ST  
Doublex Face Plate**  
Ambalaj: 1 adet  
Packaging: 1 pcs



**D**ÖŞEME ALTI ÇIKIŞ GÜÇ DAĞITIM KUTULARI  
UNDERFLOOR POWER DISTRIBUTION BOXES

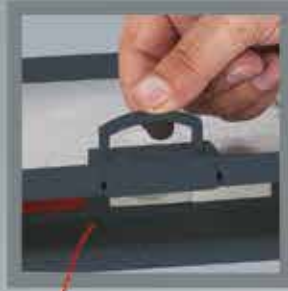

Açıp kapamayı kolaylaştıran tutma ünitesi

Holding unit makes easy opening & closing



Üzerine ağırlık binmesi halinde kablolarda hasar oluşmasını önleyecek kauçuk kapatıcı.

Specially designed rubber part that protects any damage comes from weight factor



Gövde ve kapak bağlantısındaki dayanıklılığı artıran metal pim.

Extra durability with its distinctively made steel pin that helps the endurance between body and cover parts



Döşemeyle arasındaki seviye farkını ayarlama aparatları.

Adjustment apparatus to balance the level difference on the floor



Kapakta çift taraflı monte etme imkanı

Two sided possibility to mount cover part

Tırnak geçmeli sistemi ile kolay montaj edilebilen priz çekirdeği yuvaları  
Easy installation with plug-in system nail connection system

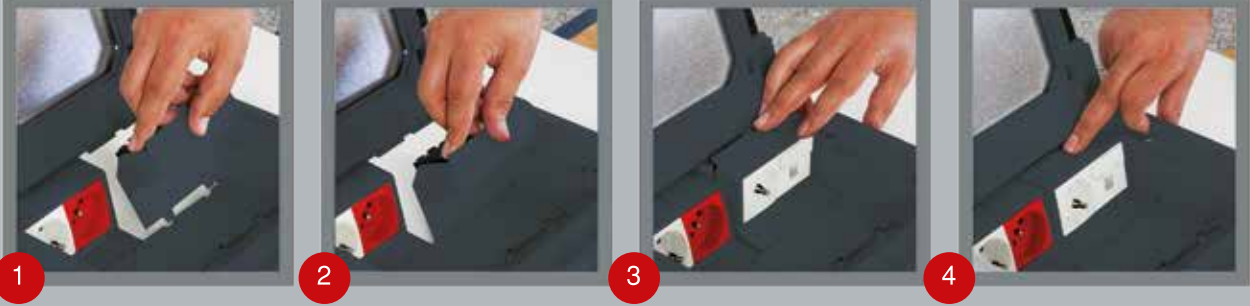

### BOYUTLAR / DIMENSIONS

#### DIŞ KASA / OUTER BOX

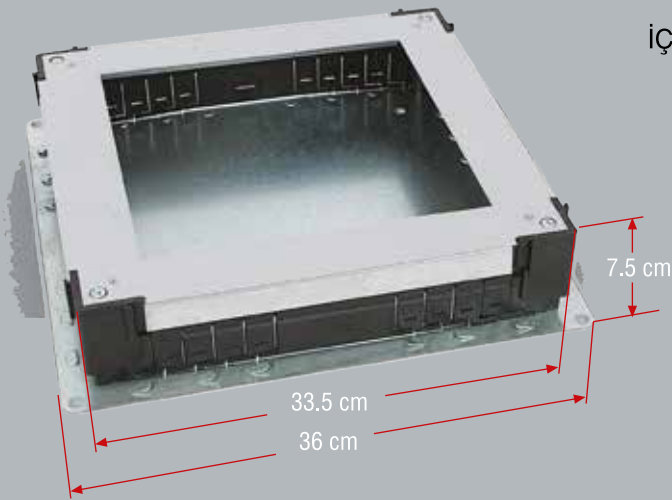

#### İÇ KASA / INNER BOX

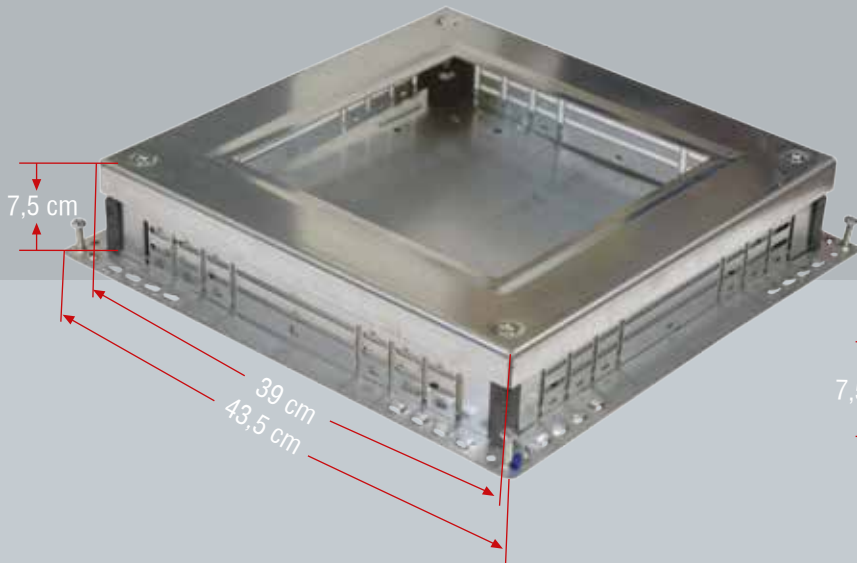
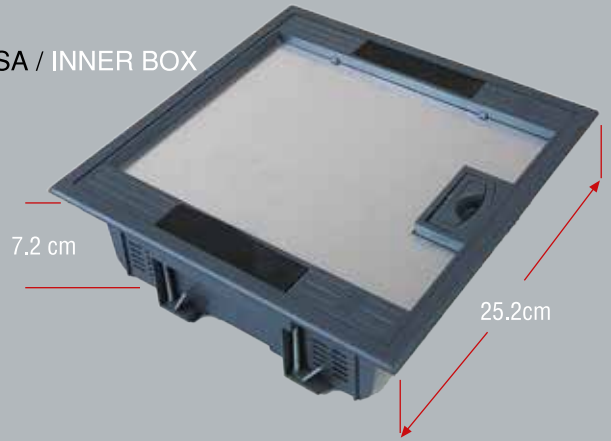

DÖŞEME ALTI ÇIKIŞ GÜÇ DAĞITIM KUTULARI  
UNDERFLOOR POWER DISTRIBUTION BOXES



Ref: 890 08

Döşeme Altı Çıkış Kutusu  
16 Modül 45x22.5mm

Underfloor Socket Output Box 16 Module

Ambalaj: 1 adet / Packaging: 1 pcs

4 Kaide / 4 Frame

Gövde ölçüsü: 23.5x23.5 cm

Body size: 23.5x23.5 cm

\* Boş Satılır / Sales without modules

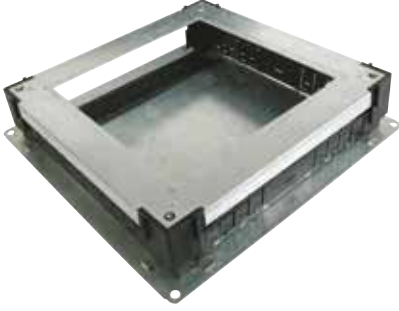

Ref: 890 09

Şap Altı Buat Kasası

Underfloor Box Metallic Base

Asansörlü / Lift system

Dış ölçü: 36x36 cm Outer size: 36x36 cm

Ambalaj: 1 adet / Packaging: 1 pcs



Ref: 890 11

Şap Altı Buat Kasası Plastik

Underfloor Box Plastic base

Ambalaj: 1 adet / Packaging: 1 pcs

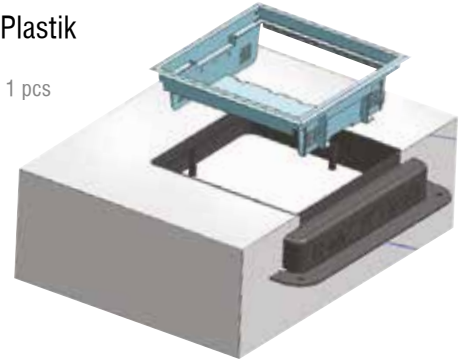

Ref: 890 13

Şap Altı Buat Kasası Kapağı

Underfloor Box Metallic Base Cover

Dış ölçü: 23.5x23.5 cm Outer size: 23.5x23.5 cm

Ambalaj: 1 adet / Packaging: 1 pcs



**DÖŞEME ALTI ÇIKIŞ GÜÇ DAĞITIM KUTULARI**  
**UNDERFLOOR POWER DISTRIBUTION BOXES****Ref: 890 15****Döşeme Altı Çıkış Kutusu**  
**24 Modül 45x22.5mm**

Underfloor Socket Output Box 24 Module

Ambalaj: 1 adet / Packaging: 1 pcs

Gövde ölçüsü: 25x25 cm Body size: 25x25 cm

\* Boş Satılır / Sales without modules

**Ref: 890 14****Şap Altı Buat Kasası Büyük**

Underfloor Box Metallic Base Big Size

Asansörlü / Lift system

Dış ölçü: 43,5x43,5 cm Outer size: 43,5x43,5 cm

Ambalaj: 1 adet / Packaging: 1 pcs

**Ref: 890 16****Şap Altı Buat Kasası Kapağı**

Underfloor Box Base Cover

Dış ölçü: 25x25 cm Outer size: 25x25 cm

Ambalaj: 1 adet / Packaging: 1 pcs

### KABLO BAĞLARI / CABLE TIES



Ürün Kodu Product Code	Boyutlar / Dimensions		Renk Colour	Azami Sıkma Çapı (mm) Maximum coupling diameter (mm)	Açılma Mukavemeti Expansion Resistance	Poşet Miktarı Packaging Units
	Uzunluk x En (mm) Length x Width (mm)					
TSL - 100 M TSL - 140 M TSL - 200 M	100 150 200	2,5	Beyaz / Siyah Beyaz / Siyah Beyaz / Siyah	25 38 50	8 kg	100 ad./pcs
TSL - 150 I TSL - 200 I TSL - 250 I TSL - 300 I TSL - 370 I	150 200 250 300 370	3,6	Beyaz / Siyah Beyaz / Siyah Beyaz / Siyah Beyaz / Siyah Beyaz / Siyah	38 57 69 87 110	18 kg	
TSL - 200 ST TSL - 250 ST TSL - 300 ST TSL - 380 ST TSL - 400 ST	200 250 300 380 400	4,8	Beyaz / Siyah Beyaz / Siyah Beyaz / Siyah Beyaz / Siyah Beyaz / Siyah	56 72 87 109 129	22 kg	
TSL - 300 LHD TSL - 380 LHD TSL - 550 LHD	300 380 550	7,6	Beyaz / Siyah Beyaz / Siyah Beyaz / Siyah	82 108 162	54 kg	
TSL - 750 LHD	750	9,0	Beyaz / Siyah	233	79 kg	

### YAPIŞKAN KROŞELER / ADHESIVE CROSHETS



Ürün Kodu Product Code	Boyutlar / Dimensions		Renk Colour	Kablo Bağı Girişi (mm) Cable Tie Entrance	Taşıma Mukavemeti Carriage Resistance	Poşet Miktarı Packaging Units
	Uzunluk x En (mm) Length x Width (mm)					
SDM - 101 SDM - 102	19 28	19 28	Beyaz / Siyah Beyaz / Siyah	4 4,5	8 kg 15 kg	100 ad.





**D**AHİLİ 45x45 MODÜL PRİZ KUTULARI / YAPISAL KABLOLAMA SİSTEMLERİ  
45x45 SOCKET BOXES / STRUCTURAL CABLING SYSTEMS

## DAHİLİ 45x45 MODÜL PRİZ KUTULARI 45x45 SOCKET BOXES



880 08

### 8'li Modül Priz Kutusu 45x45mm

Socket Box for 8 Module 45x45mm  
Ölçüsü: 210x110x70mm Size: 210x110x70mm  
Ambalaj: 1 adet / Packaging: 1 pcs



880 09

### Dağıtım Buatı

Distribution Box  
Ölçüsü / Size: 210x110x70mm  
Ambalaj: 1 adet / Packaging: 1 pcs

## YAPISAL KABLOLAMA SİSTEMLERİ STRUCTURAL CABLING SYSTEMS

### PATCH PANEL



245 70	1 Adet / Pcs	CAT5 e UTP Patch Panel 24 Port
245 71	1 Adet / Pcs	CAT5 e UTP Patch Panel 48 Port
245 72	1 Adet / Pcs	CAT6 e UTP Patch Panel 24 Port
245 73	1 Adet / Pcs	CAT6 e UTP Patch Panel 48 Port

### PATCH CORD



245 80	1 Adet / Pcs	CAT5 e UTP 24 AWG Patch Cord 1m
245 81	1 Adet / Pcs	CAT5 e UTP 24 AWG Patch Cord 3m
245 82	1 Adet / Pcs	CAT5 e UTP 24 AWG Patch Cord 5m
245 83	1 Adet / Pcs	CAT6 e UTP 24 AWG Patch Cord 1m
245 84	1 Adet / Pcs	CAT6 e UTP 24 AWG Patch Cord 3m

### KABLO OMURGASI



877 40

877 39	1 Adet / Pcs	Kablo Omurgası Cable Spine
877 40B	1 Adet / Pcs	Kablo Omurgası Cable Spine
877 40G	1 Adet / Pcs	Kablo Omurgası Cable Spine
877 40W	1 Adet / Pcs	Kablo Omurgası Cable Spine
877 40N	1 Adet / Pcs	Kablo Omurgası Cable Spine



### 1U ORGANİZER

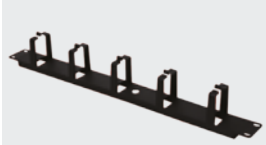

245 19	1 Adet / Pcs	Organizer Organizer
--------	-----------------	------------------------



Bu ürün grubu ile ilgili özel uygulama siparişleri alınır.  
*Custom made application orders are welcome in this product group.*



**O** FİS BLOK SİSTEMLERİ  
BLOCK OFFICE SYSTEMS

OFİS BLOK SİSTEMLERİ  
BLOCK OFFICE SYSTEMS



<b>980 01</b>	1 Adet / Pcs	4 UPS + 3 ŞBK + 2 TLF + 2 DATA	(594x65x52 mm)
<b>980 02</b>	1 Adet / Pcs	4 UPS + 3 ŞBK + 2 TLF + 1 DATA	(572x65x52 mm)
<b>980 03</b>	1 Adet / Pcs	4 UPS + 3 ŞBK + 1 TLF + 1 DATA	(549x65x52 mm)
<b>980 04</b>	1 Adet / Pcs	4 UPS + 2 ŞBK + 2 TLF + 2 DATA	(549x65x52 mm)
<b>980 05</b>	1 Adet / Pcs	4 UPS + 2 ŞBK + 2 TLF + 1 DATA	(527x65x52 mm)
<b>980 06</b>	1 Adet / Pcs	4 UPS + 2 ŞBK + 1 TLF + 1 DATA	(504x65x52 mm)



<b>980 07</b>	1 Adet / Pcs	4 UPS + 1 ŞBK + 2 TLF + 2 DATA	(504x65x52 mm)
<b>980 08</b>	1 Adet / Pcs	4 UPS + 1 ŞBK + 2 TLF + 1 DATA	(482x65x52 mm)
<b>980 09</b>	1 Adet / Pcs	4 UPS + 1 ŞBK + 1 TLF + 1 DATA	(459x65x52 mm)
<b>980 10</b>	1 Adet / Pcs	3 UPS + 3 ŞBK + 2 TLF + 2 DATA	(549x65x52 mm)
<b>980 11</b>	1 Adet / Pcs	3 UPS + 3 ŞBK + 2 TLF + 1 DATA	(527x65x52 mm)
<b>980 12</b>	1 Adet / Pcs	3 UPS + 3 ŞBK + 1 TLF + 1 DATA	(504x65x52 mm)



<b>980 13</b>	1 Adet / Pcs	3 UPS + 2 ŞBK + 2 TLF + 2 DATA	(504x65x52 mm)
<b>980 14</b>	1 Adet / Pcs	3 UPS + 2 ŞBK + 2 TLF + 1 DATA	(482x65x52 mm)
<b>980 15</b>	1 Adet / Pcs	3 UPS + 2 ŞBK + 1 TLF + 1 DATA	(459x65x52 mm)
<b>980 16</b>	1 Adet / Pcs	3 UPS + 1 ŞBK + 2 TLF + 2 DATA	(459x65x52 mm)
<b>980 17</b>	1 Adet / Pcs	3 UPS + 1 ŞBK + 2 TLF + 1 DATA	(437x65x52 mm)
<b>980 18</b>	1 Adet / Pcs	3 UPS + 1 ŞBK + 1 TLF + 1 DATA	(414x65x52 mm)



<b>980 19</b>	1 Adet / Pcs	2 UPS + 2 ŞBK + 2 TLF + 2 DATA	(459x65x52 mm)
<b>980 20</b>	1 Adet / Pcs	2 UPS + 2 ŞBK + 2 TLF + 1 DATA	(437x65x52 mm)
<b>980 21</b>	1 Adet / Pcs	2 UPS + 2 ŞBK + 1 TLF + 1 DATA	(414x65x52 mm)
<b>980 22</b>	1 Adet / Pcs	2 UPS + 1 ŞBK + 2 TLF + 2 DATA	(414x65x52 mm)
<b>980 23</b>	1 Adet / Pcs	2 UPS + 1 ŞBK + 2 TLF + 1 DATA	(392x65x52 mm)
<b>980 24</b>	1 Adet / Pcs	2 UPS + 1 ŞBK + 1 TLF + 1 DATA	(369x65x52 mm)



<b>980 25</b>	1 Adet / Pcs	2 UPS + 1 ŞBK + 1 TLF	(347x65x52 mm)
<b>980 26</b>	1 Adet / Pcs	1 UPS + 1 ŞBK + 1 TLF + 1 DATA	(324x65x52 mm)
<b>980 27</b>	1 Adet / Pcs	1 UPS + 1 ŞBK + 1 TLF	(302x65x52 mm)
<b>980 28</b>	1 Adet / Pcs	4 UPS + 3 ŞBK	(504x65x52 mm)
<b>980 29</b>	1 Adet / Pcs	4 UPS + 2 ŞBK	(459x65x52 mm)
<b>980 30</b>	1 Adet / Pcs	4 UPS + 1 ŞBK	(414x65x52 mm)
<b>980 31</b>	1 Adet / Pcs	3 UPS + 3 ŞBK	(459x65x52 mm)
<b>980 32</b>	1 Adet / Pcs	3 UPS + 2 ŞBK	(414x65x52 mm)
<b>980 33</b>	1 Adet / Pcs	3 UPS + 1 ŞBK	(369x65x52 mm)
<b>980 34</b>	1 Adet / Pcs	2 UPS + 2 ŞBK	(369x65x52 mm)
<b>980 35</b>	1 Adet / Pcs	2 UPS + 1 ŞBK	(324x65x52 mm)
<b>980 36</b>	1 Adet / Pcs	1 UPS + 1 ŞBK	(279x65x52 mm)

\* ŞBK= Grounded Socket (245 45)

## OFİS BLOK SİSTEMLERİ BLOCK OFFICE SYSTEMS



980 37	1 Adet / Pcs	10 UPS (639x65x52 mm)
980 38	1 Adet / Pcs	9 UPS (594x65x52 mm)
980 39	1 Adet / Pcs	8 UPS (549x65x52 mm)
980 40	1 Adet / Pcs	7 UPS (504x65x52 mm)
980 41	1 Adet / Pcs	6 UPS (459x65x52 mm)
980 42	1 Adet / Pcs	5 UPS (414x65x52 mm)
980 43	1 Adet / Pcs	4 UPS (369x65x52 mm)
980 44	1 Adet / Pcs	3 UPS (324x65x52 mm)
980 45	1 Adet / Pcs	2 UPS (279x65x52 mm)



980 46	1 Adet / Pcs	10 ŞBK (639x65x52 mm)
980 47	1 Adet / Pcs	9 ŞBK (594x65x52 mm)
980 48	1 Adet / Pcs	8 ŞBK (549x65x52 mm)
980 49	1 Adet / Pcs	7 ŞBK (504x65x52 mm)
980 50	1 Adet / Pcs	6 ŞBK (459x65x52 mm)
980 51	1 Adet / Pcs	5 ŞBK (414x65x52 mm)
980 52	1 Adet / Pcs	4 ŞBK (369x65x52 mm)
980 53	1 Adet / Pcs	3 ŞBK (324x65x52 mm)
980 54	1 Adet / Pcs	2 ŞBK (279x65x52 mm)

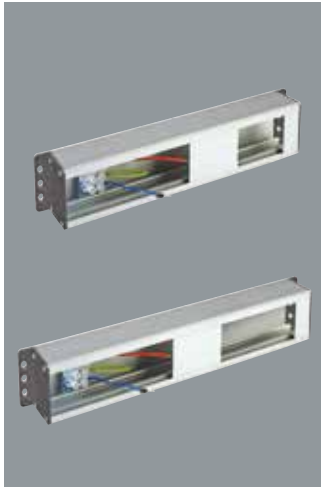

980 55	1 Adet / Pcs	4 Modül Boş Blok 2 Yan Kapak (279x65x52 mm) 4 Module Empty With 2 Side Covers (279x65x52 mm)
980 56	1 Adet / Pcs	6 Modül Boş Blok 2 Yan Kapak (324x65x52 mm) 6 Module Empty With 2 Side Covers (324x65x52 mm)
980 57	1 Adet / Pcs	8 Modül Boş Blok 2 Yan Kapak (369x65x52 mm) 8 Module Empty With 2 Side Covers (369x65x52 mm)
980 58	1 Adet / Pcs	10 Modül Boş Blok 2 Yan Kapak (414x65x52 mm) 10 Module Empty With 2 Side Covers (414x65x52 mm)
980 59	1 Adet / Pcs	12 Modül Boş Blok 2 Yan Kapak (459x65x52 mm) 12 Module Empty With 2 Side Covers (459x65x52 mm)
980 60	1 Adet / Pcs	14 Modül Boş Blok 2 Yan Kapak (504x65x52 mm) 14 Module Empty With 2 Side Covers (504x65x52 mm)
980 61	1 Adet / Pcs	16 Modül Boş Blok 2 Yan Kapak (549x65x52 mm) 16 Module Empty With 2 Side Covers (549x65x52 mm)
980 62	1 Adet / Pcs	18 Modül Boş Blok 2 Yan Kapak (594x65x52 mm) 18 Module Empty With 2 Side Covers (594x65x52 mm)
980 63	1 Adet / Pcs	20 Modül Boş Blok 2 Yan Kapak (639x65x52 mm) 20 Module Empty With 2 Side Covers (639x65x52 mm)

\* ŞBK= Grounded Socket (245 45)



980 65

Kabin Tipi Sigortalı Priz Bloğu (6 ŞBK 1U)  
Rack Cabinet Type 1U Power Socket Group  
With Circuit Breaker (6 sockets with fuse)  
Ambalaj: 1 adet / Packaging: 1 pcs



980 68

Kabin Tipi Anahtarlı Priz Bloğu (6 ŞBK 1U)  
Rack Cabinet Type 1U Power Socket Group  
With Switch (6 sockets with fuse)  
Ambalaj: 1 adet / Packaging: 1 pcs



980 69

Kabin Tipi Şok Korumalı Priz Bloğu (6 ŞBK 1U)  
Rack Cabinet Type 1U Power Socket Group  
With Parafudr (6 sockets with fuse)  
Ambalaj: 1 adet / Packaging: 1 pcs



**M**ASA ÜSTÜ PRİZ SİSTEMLERİ ve ALÜMİNYUM SÜTUNLAR  
DESKTOP SOCKET SYSTEMS & ALUMINIUM COLUMNS

**Ç**ALIŞMA ORTAMI ÇÖZÜMLERİ  
WORK STATION SOLUTIONS



**DİKEY PRİZ BLOKLARI**  
**VERTICAL ALLUMINIUM FLOOR STANDING POWER SOCKET**

**980 64 Dikey Tekyüz Priz Bloğu**  
One Face Vertical Alluminium Floor  
Ambalaj: 1 adet / Packaging: 1 pcs

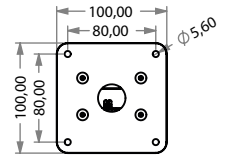
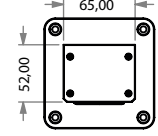
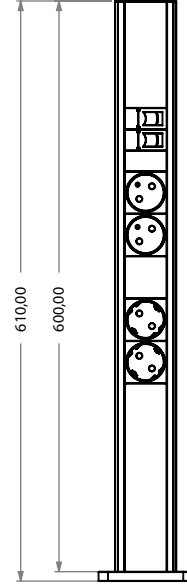

**980 66 Dikey Çift yüz Priz Bloğu**  
Double Face Vertical Alluminium Floor  
Ambalaj: 1 adet / Packaging: 1 pcs

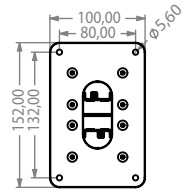
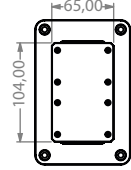
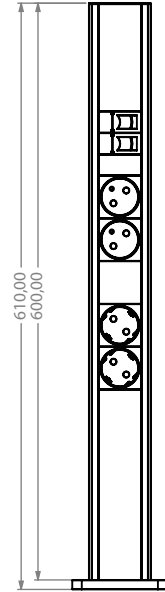

**980 67 Dikey Dört yüz Priz Bloğu**  
Four Face Vertical Alluminium Floor  
Ambalaj: 1 adet / Packaging: 1 pcs

Boş Satılır.  
Priz kombinasyonları için  
fiyat sorunuz.  
Sales (without sockets) as empty  
Ask for pricing with different  
socket combinations.

MASA OFİS BLOK SİSTEMLERİ / DEKSTOP SOCKET SYSTEMS

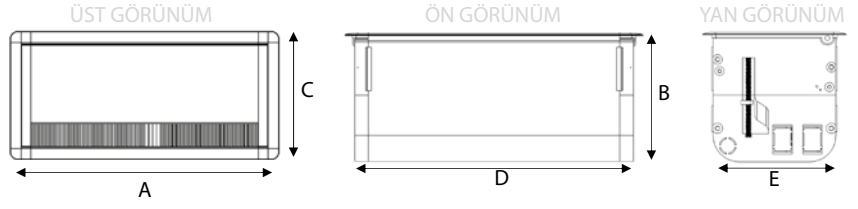

CODE	MODULE	RENK/COLOR	Yuva Ölçüsü Slot Size (mm)
9810501	5	Anodized	D:156 E:98
9810502		Siyah/Black	
9810503		Beyaz/White	
9810801	8	Anodized	D:225 E:98
9810802		Siyah/Black	
9810803		Beyaz/White	
9811201	12	Anodized	D:325 E:98
9811202		Siyah/Black	
9811203		Beyaz/White	
9811601	16	Anodized	D:405 E:98
9811602		Siyah/Black	
9811603		Beyaz/White	
9812001	20	Anodized	D:495 E:98
9812002		Siyah/Black	
9812003		Beyaz/White	

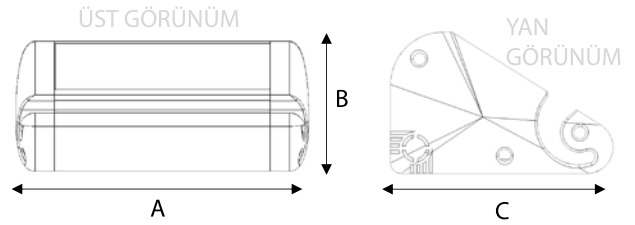

CODE	MODULE	RENK/COLOR	Ölçüsü/Size (mm)
9840501	5	Anodized	A:153 B:68 C:108
9840502		Siyah/Black	
9840503		Beyaz/White	
9840801	8	Anodized	A:221 B:68 C:108
9840802		Siyah/Black	
9840803		Beyaz/White	
9841201	12	Anodized	A:311 B:68 C:108
9841202		Siyah/Black	
9841203		Beyaz/White	
9841601	16	Anodized	A:401 B:68 C:108
9841602		Siyah/Black	
9841603		Beyaz/White	
9842001	20	Anodized	A:491 B:68 C:108
9842002		Siyah/Black	
9842003		Beyaz/White	

MASA OFİS BLOK SİSTEMLERİ / DEKSTOP SOCKET SYSTEMS



CODE	MODULE	RENK/COLOR	Yuva Ölçüsü Slot Size (mm)
9990601	6	Inox	Ø100
9990602		Siyah/Black	
9990603		Bronz/Broze	
9990604		Altın/Gold	
9990801	8	Inox	Ø100
9990802		Siyah/Black	
9990803		Bronz/Broze	
9990804		Altın/Gold	
9991001	10	Inox	Ø100
9991002		Siyah/Black	
9991003		Bronz/Broze	
9991004		Altın/Gold	



CODE	MODULE	RENK/COLOR	Adet/Unit
9850501	5	Anodized	5
9850502		Siyah/Black	
9850503		Beyaz/White	
9850801	8	Anodized	8
9850802		Siyah/Black	
9850803		Beyaz/White	
9851201	12	Anodized	12
9851202		Siyah/Black	
9851203		Beyaz/White	
9851601	16	Anodized	16
9851602		Siyah/Black	
9851603		Beyaz/White	
9852001	20	Anodized	20
9852002		Siyah/Black	
9852003		Beyaz/White	





985 06 01 Masa Ofis Blok  
Desktop Socket Block  
6 Modül / 6 Module  
Beyaz / White  
1 Adet / Pcs



985 06 02 Masa Ofis Blok  
Desktop Socket Block  
6 Modül / 6 Module  
Siyah / Black  
1 Adet / Pcs

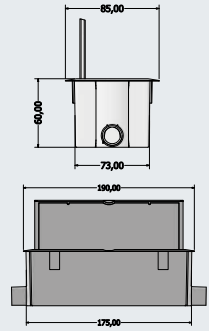

985 06 03 Masa Ofis Blok  
Desktop Socket Block  
6 Modül / 6 Module  
Gri / Gray  
1 Adet / Pcs

### YUVARLAK 3 MODÜL MASA BLOĞU CIRCLE 3 MODULE DESKTOP SOCKET SYSTEMS



999 03 01 Yuvarlak Masa Ofis Blok  
Circle Desktop Socket Block  
3 Modül / 3 Module  
Beyaz / White  
1 Adet / Pcs

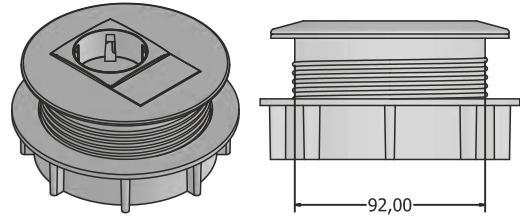

999 03 02 Masa Ofis Blok  
Desktop Socket Block  
3 Modül / 3 Module  
Gri / Gray  
1 Adet / Pcs

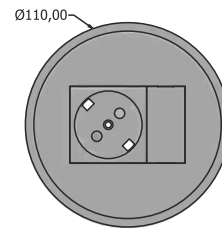

**METAL MASA ÜSTÜ KABLOSUZ ŞARJLI PRİZ BLOĞU**  
**METAL DESKTOP WIRELESS CHARGING SYSTEM**

Kasaya sabitlenmiş 15w gücündeki kablosuz şarj sistemi sayesinde telefonunu kolaylıkla kablosuz hızlı şarj edebilirsiniz.

Via the 15 watt wireless charging system which is fixed to the case, your phone can be charged easily, wirelessly and quickly.

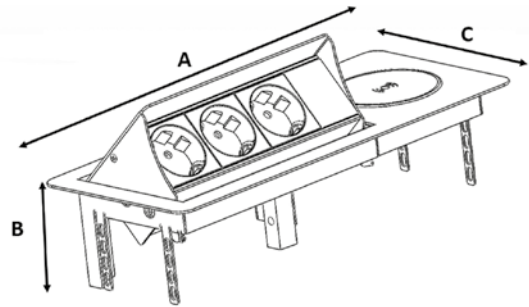

Kod / Code	Modül / Module	Renk	Ölçü / Size (mm)	Yuva Ölçüsü / Slot Size (mm)
981 03 01	6 Modül	Inox	A: 301 B:72 C:132	275x100
981 03 02	6 Modül	Siyah/Black	A: 301 B:72 C:132	275x100
981 03 03	6 Modül	Beyaz/White	A: 301 B:72 C:132	275x100

**Genel Özellikler:**

- 3 adetten, 42 adede kadar ulaşabilen modüler soket sayısı.
- 1U – 2U genişliğinde alüminyum gövde.
- Schuko, UPS, Universal, UK, C13, C19 soket tipleri.
- CEE 7/7, C14, C20 , BS1363, endüstriyel fiş (1P, 3P, 16A, 32A) soket çeşitliliği.

**IP PDU (Ethernet Bağlantılı Akıllı Priz Sistemleri)**

- Giriş izleme özellikli PDU'lar
- 1P / 3P izleme özelliği
- W, V, A, kWh izleme özellikli
- Sıcaklık / Nem sensörü bağlanabilme

**İlave Özellikler**

- Otomatik sigorta, On-off anahtar, Termik sigorta, V-I dijital ölçer , V-I-P-PF dijital ölçer, Surge protection opsiyonları.

**Kablo Seçenekleri**

- 3x1 mm<sup>2</sup>, 3x1,5 mm<sup>2</sup>, 3x2,5 mm<sup>2</sup>, 3x4 mm<sup>2</sup>, 3x6 mm<sup>2</sup>, 5x2,5 mm<sup>2</sup>, 5x4 mm<sup>2</sup>, 5x6 mm<sup>2</sup> kablo çeşitliliği

**Kablo Uzunluğu Seçenekleri**

- 1,5 m, 2 m, 2,5 m, 3 m

**General Features:**

- 3 Pcs of modular sockets, up to 42 pcs reachable.
- 1U – 2U wide aluminum body.
- Schuko, UPS, Universal, UK, C13, C19 socket types.
- CEE 7/7, C14, C20, BS1363, industrial plug (1P, 3P, 16A, 32A) socket assortment.

**IP PDU (Ethernet Connected Intelligent Power Socket Systems)**

- PDU monitoring
- 1P/3P monitoring feature
- W, V, A, kWh monitoring
- Thermal and Humidity sensor

**Additional Features**

- Auto fuse, On-off switch, Thermal fuse, V-I digital meter, V-I-P-PF digital meter, Surge protection options.

**Cable Options:**

- 3x1 mm<sup>2</sup>, 3x1,5 mm<sup>2</sup>, 3x2,5 mm<sup>2</sup>, 3x4 mm<sup>2</sup>, 3x6 mm<sup>2</sup>, 5x2,5 mm<sup>2</sup>, 5x4 mm<sup>2</sup>, 5x6 mm<sup>2</sup> cable assortment

**Cable Length Options:**

- 1,5 mt, 2 mt, 2,5 mt, 3 mt

**P****DU GÜÇ DAĞITIM SİSTEMLERİ  
POWER DISTRIBUTION UNITS SYSTEM**

## BASIC PDU

### 1U Yatay Tip / 1U Horizontal



#### 6 x Alman Tipi (Schuko) (DIN 49440) Priz / 6 x Schuko (DIN 49440) Socket

Kod Code	Açıklama Description	Opsiyonlar Options	Ölçüler Size
11001	1 Faz 250 VAC Giriş, IP20, 16 A, 4.0 kW, 6 x Alman tipi priz (DIN 49440), H05VV-F 3G1,5 mm <sup>2</sup> Alman tipi fişli siyah kablo (DIN 49441)		482 X 44 X 44 mm
11002		On/Off Işıklı Anahtar	482 X 55 X 44 mm
11003		1X16 A Oto. Sigorta(MCB)	482 X 86 X 44 mm

#### 8 x Alman Tipi (Schuko) (DIN 49440) Priz / 8 x Schuko (DIN 49440) Socket

Kod Code	Açıklama Description	Opsiyonlar Options	Ölçüler Size
11004	1 Faz 250 VAC Giriş, IP20, 16 A, 4.0 kW, 8 x Alman tip priz (DIN 49440), H05VV-F 3G1,5 mm <sup>2</sup> Alman tipi fişli siyah kablo (DIN 49441)	-	482 X 44 X 44 mm



#### 6 x Fransız Tipi Priz (NF C 61314) / 6 x French Type (NF C 61314) Socket

Kod Code	Açıklama Description	Opsiyonlar Options	Ölçüler Size
11005	1 Faz 250 VAC Giriş, IP20, 16 A, 4.0 kW, 3 x Fransız Tipi Priz, H05VV-F 3G1,5 mm <sup>2</sup> Alman Tipi fişli siyah kablo (DIN 49441)		482 X 44 X 44 mm
11006		On/Off Işıklı Anahtar	482 X 55 X 44 mm
11007		1X16 A Oto. Sigorta(MCB)	482 X 86 X 44 mm

#### 8 x Fransız Tipi Priz (NF C 61314) / 8 x French Type (NF C 61314) Socket

Kod Code	Açıklama Description	Opsiyonlar Options	Ölçüler Size
11008	1 Faz 250 VAC Giriş, IP20, 16 A, 4.0 kW, 6 x Fransız Tipi Priz, H05VV-F 3G1,5 mm <sup>2</sup> Alman Tipi fişli siyah kablo (DIN 49441)	-	482 X 44 X 44 mm



#### 6 x İngiliz Tipi Priz (BS 1363) / 6 x British Type (BS 1363) Socket

Kod Code	Açıklama Description	Opsiyonlar Options	Ölçüler Size
11009	1 Faz 250 VAC Giriş IP20, 13 A, 3.2 Kw, 6 x İngiliz Tipi Priz (BS 1363), H05VV-F 3G1,5 mm <sup>2</sup> 13A sigortalı İngiliz Tipi fişli siyah kablo (BS 1363)		482 X 44 X 44 mm
11010		On/Off Işıklı Anahtar	482 X 55 X 44 mm

## BASIC PDU

### 1U Yatay Tip / 1U Horizontal



#### 6 x IEC320 C19 Priz / 6 x IEC320 C19 Socket

Kod Code	Açıklama Description	Opsiyonlar Options	Ölçüler Size
11011			482 X 44 X 44 mm
11012	1 Faz 250 VAC Giriş, IP20, 16 A, 4.0 kW, 6 x IEC320 C19 Priz, H05VV-F 3G1,5 mm <sup>2</sup> IEC-C20 Fişli siyah kablo	On/Off Işıklı Anahtar	482 X 55 X 44 mm
11013		Aşırı Gerilim Koruma	482 X 86 X 44 mm

#### 6 x IEC320 C13 Priz / 6 x IEC320 C13 Socket

Kod Code	Açıklama Description	Opsiyonlar Options	Ölçüler Size
11012			482 X 44 X 44 mm
11013	1 Faz 250 VAC Giriş, IP20, 16 A, 4.0 kW, 6 x IEC320 C19 Priz, H05VV-F 3G1,5 mm <sup>2</sup> IEC-C20 Fişli siyah kablo	On/Off Işıklı Anahtar	482 X 55 X 44 mm
11014		On/Off Işıklı Anahtar, Aşırı Gerilim Koruma	482 X 55 X 44 mm
11015			482 X 44 X 44 mm
11016	1 Faz 250 VAC Giriş, IP20, 10 A, 2.5 kW, 6 x IEC320 C13 Priz, H05VV-F 3G1,0 mm <sup>2</sup> IEC-C14 fişli siyah kablo	On/Off Işıklı Anahtar	482 X 55 X 44 mm
11017		1X16A Oto. Sigorta(MCB)	482 X 86 X 44 mm
11018		On/Off Işıklı Anahtar, Aşırı Gerilim Koruma	482 X 55 X 44 mm

#### 8 x IEC320 C13 Priz / 8 x IEC320 C13 Socket

Kod Code	Açıklama Description	Opsiyonlar Options	Ölçüler Size
11019			482 X 44 X 44 mm
11020	1 Faz 250 VAC Giriş, IP20, 10 A, 2.5 kW, 8 x IEC320 C13 Priz, H05VV-F 3G1,0 mm <sup>2</sup> IEC-C14 fişli siyah kablo	On/Off Işıklı Anahtar	482 X 55 X 44 mm
11021		On/Off Işıklı Anahtar, Aşırı Gerilim Koruma	482 X 55 X 44 mm
11022			482 X 44 X 44 mm
11023	1 Faz 250 VAC Giriş, IP20, 16 A, 4.0 kW, 8 x IEC320 C13 Priz, H05VV-F 3G1,5 mm <sup>2</sup> fişli siyah kablo	On/Off Işıklı Anahtar	482 X 55 X 44 mm
11024		1X16A Otomatik Sigorta	482 X 86 X 44 mm
11025		On/Off Işıklı Anahtar, Aşırı Gerilim Koruma	482 X 55 X 44 mm

#### 10 x IEC320 C13 Priz / 10 x IEC320 C13 Socket

Kod Code	Açıklama Description	Opsiyonlar Options	Ölçüler Size
11026			482 X 44 X 44 mm
11027	1 Faz 250 VAC Giriş, IP20, 10 A, 2.5 kW, 10 x IEC320 C13 Priz , H05VV-F 3G1,0 mm <sup>2</sup> IEC-C14 fişli siyah kablo	On/Off Işıklı Anahtar	482 X 55 X 44 mm
11028		Aşırı Gerilim Koruma	482 X 44 X 44 mm
11029			482 X 44 X 44 mm
11030	1 Faz 250 VAC Giriş, IP20, 16 A, 4.0 kW, 10 x IEC320 C13 Priz, H05VV-F 3G1,5 mm <sup>2</sup> fişli siyah kablo	On/Off Işıklı Anahtar	482 X 55 X 44 mm
11031		Aşırı Gerilim Koruma	482 X 44 X 44 mm

#### 12 X IEC320 C13 Priz / 12 X IEC320 C13 Socket

Kod Code	Açıklama Description	Opsiyonlar Options	Ölçüler Size
11032	1 Faz 250 VAC Giriş IP20, 10 A, 2.5 kW, 12 X IEC320 C13 Priz, H05VV-F 3G1,0 mm <sup>2</sup> black cord with IEC-C14 plug		482 X 44 X 44 mm
11033	1 Faz 250 VAC Giriş, IP20, 16 A, 4.0 kW, 12 X IEC320 C13 Priz, H05VV-F 3G1,5 mm <sup>2</sup> fişli siyah kablo		482 X 44 X 44 mm



## BASIC PDU

### 2U Yatay Tip / 2U Horizontal

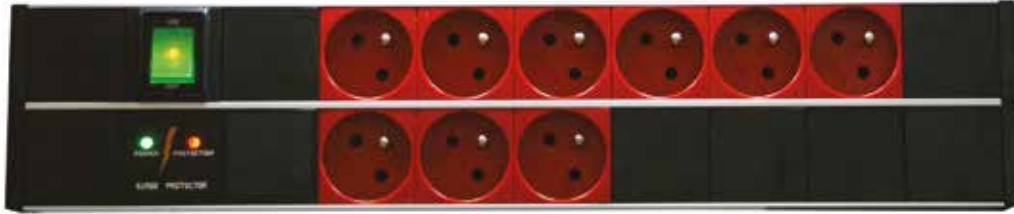

#### 9 x Alman Tipi (Schuko) (DIN 49440) Priz / 9 x Schuko (DIN 49440) Socket

Kod Code	Açıklama Description	Opsiyonlar Options	Ölçüler Size
20001	1 Faz 250 VAC Giriş, IP20, 16 A, 4.0 kW, 6 x Alman tipi priz (DIN 49440), H05VV-F 3G1,5 mm <sup>2</sup> Alman tipi fişli siyah kablo (DIN 49441)		482 X 44 X 88 mm
20002		On/Off Işıklı Anahtar	482 X 55 X 88 mm
20003		1X16 A Oto. Sigorta(MCB)	482 X 86 X 88 mm
20004		On/Off Işıklı Anahtar, Aşırı Gerilim Koruma	482 X 55 X 88 mm
20005		1X16 A Oto. Sigorta(MCB), Aşırı Gerilim Koruma,	482 X 86 X 88 mm

#### 9 x Fransız Tipi (NF C 61314) Priz / 9 x French Type (NF C 61314) Socket

Kod Code	Açıklama Description	Opsiyonlar Options	Ölçüler Size
20006	1 Faz 250 VAC Giriş, IP20, 16 A, 4.0 kW, 9 x Fransız Tipi Priz, H05VV-F 3G1,5 mm <sup>2</sup> Alman Tipi Schuko DIN 49441 fişli siyah kablo		482 X 44 X 88 mm
20007		On/Off Işıklı Anahtar	482 X 55 X 88 mm
20008		1X16 A Oto. Sigorta(MCB)	482 X 86 X 88 mm
20009		16A On/Off Işıklı Anahtar, Aşırı Gerilim Koruma	482 X 55 X 88 mm

#### 10 x İngiliz Tipi (BS 1363) Priz / 10 x British Type (BS 1363) Socket

Kod Code	Açıklama Description	Opsiyonlar Options	Ölçüler Size
20010	1 Faz 250 VAC Giriş, IP20, 13 A, 3.2 Kw, 10 x İngiliz Tipi (BS 1363) Priz, H05VV-F 3G1,5 mm <sup>2</sup> 13A sigortalı İngiliz Tip (BS 1363) fişli siyah kablo		482 X 44 X 88 mm
20011		On/Off Işıklı Anahtar	482 X 55 X 88 mm
20012		1X16A Oto. Sigorta(MCB)	482 X 86 X 88 mm
20013		16A On/Off Işıklı Anahtar, Aşırı Gerilim Koruma	482 X 55 X 88 mm

## BASIC PDU

### 2U Yatay Tip / 2U Horizontal



#### 12 x Alman Tipi (Schuko) (DIN 49440) Priz / 12 x Schuko (DIN 49440) Socket

Kod Code	Açıklama Description	Opsiyonlar Options	Ölçüler Size
20014	1 Faz 250 VAC Giriş IP20, 16 A, 4.0 kW, 12 x Alman Tipi ( schuko) (DIN 49440) Priz, H05VV-F 3G1,5 mm <sup>2</sup> Alman Tipi Schuko DIN 49441 fişli siyah kablo		482 X 44 X 88 mm
20015		On/Off Işıklı Anahtar	482 X 55 X 88 mm
20016		1X16A Oto. Sigorta(MCB)	482 X 86 X 88 mm
20017		On/Off Işıklı Anahtar, Aşırı Gerilim Koruma	482 X 55 X 88 mm
20018		2X16A Oto. Sigorta(MCB), 2X Fişli kablo	482 X 86 X 88 mm

#### 12 x Fransız Tipi (NF C 61314) Priz / 12 x French Type (NF C 61314) Socket

Kod Code	Açıklama Description	Opsiyonlar Options	Ölçüler Size
20019	1 Faz 250 VAC Giriş, IP20, 16 A, 4.0 kW, 12 x Fransız Tipi Priz, H05VV-F 3G1,5 mm <sup>2</sup> Alman Tipi Schuko DIN 49441 fişli siyah kablo		482 X 44 X 88 mm
20020		On/Off Işıklı Anahtar	482 X 55 X 88 mm
20021		1X16A Oto. Sigorta(MCB)	482 X 86 X 88 mm
20022		On/Off Işıklı Anahtar, Aşırı Gerilim Koruma	482 X 55 X 88 mm
20023		2X16A Oto. Sigorta(MCB), 2X Fişli kablo	

#### 12 x İngiliz Tipi (BS 1363) Priz / 12 x British Type (BS 1363) Socket

Kod Code	Açıklama Description	Opsiyonlar Options	Ölçüler Size
20024	1 Faz 250 VAC Giriş, IP20, 13 A, 3.2 Kw, 10 x İngiliz Tipi (BS 1363) Priz, H05VV-F 3G1,5 mm <sup>2</sup> 13A sigortalı İngiliz Tip ( BS 1363) fişli siyah kablo		482 X 44 X 88 mm
20025		On/Off Işıklı Anahtar	482 X 55 X 88 mm
20026		On/Off Işıklı Anahtar, Aşırı Gerilim Koruma	482 X 55 X 88 mm

## BASIC PDU

### 0U Dikey Tip / 0U Vertical



#### 12 x IEC320 C13 Priz / 12 x IEC320 C13 Socket

Kod Code	Açıklama Description	Opsiyonlar Options	Ölçüler Size
00001	1 Faz 250 VAC Giriş, IP20, 16 A, 4.0 kW, 12 X IEC320 C13 Priz, 1X16A Otomatik Sigorta, H05VV-F 3G2,5 mm <sup>2</sup> IEC309-1P 16A fişli siyah kablo	1X16A Oto. Sigorta(MCB)	A X 86 X 44 mm
00002	1 Faz 250 VAC Giriş, IP20, 16 A, 4.0 kW, (6+6) x IEC320 C13 Priz, 2X16A Otomatik Sigorta, H05VV-F 3G6 mm <sup>2</sup> IEC309-1P 32A fişli siyah kablo	2X16A Oto. Sigorta(MCB)	A X 86 X 44 mm

#### 12 x Alman Tipi (Schuko) (DIN 49440) Priz / 12 x Schuko (DIN 49440) Socket

Kod Code	Açıklama Description	Opsiyonlar Options	Ölçüler Size
00003	1 Faz 250 VAC Giriş, IP20, 16 A, 4.0 kW, (6 + 6) x Alman Tipi (DIN 49440) Priz, 2X16A Otomatik Sigorta, H05VV-F 3G6 mm <sup>2</sup> IEC309-1P 32A fişli siyah kablo	2X16A Oto. Sigorta(MCB)	A X 86 X 44 mm

#### 12 x Fransız Tipi (NF C 61314) Priz / 12 x French (NF C 61314) Socket

Kod Code	Açıklama Description	Opsiyonlar Options	Ölçüler Size
00004	1 Faz 250 VAC Giriş, IP20, 16 A, 4.0 kW, (6 + 6) x Fransız Tipi Priz, 2X16A Otomatik Sigorta, H05VV-F 3G6 mm <sup>2</sup> IEC309-1P 32A fişli siyah kablo	2X16A Oto. Sigorta(MCB)	A X 86 X 44 mm

#### (4 + 4) x IEC320 C13 Priz + (2 + 2) x IEC320 C19 Priz / (4 + 4) x IEC320 C13 Socket + (2 + 2) x IEC320 C19 Socket

Kod Code	Açıklama Description	Opsiyonlar Options	Ölçüler Size
00005	1 Faz 250 VAC Giriş, IP20, 16 A, 4.0 kW, (4+4) x IEC320 C13 Priz + (2 + 2) x IEC320 C19 Priz, 2X16A Otomatik Sigorta, H05VV-F 3G6 mm <sup>2</sup> IEC309-1P 32A fişli siyah kablo	2X16A Oto. Sigorta(MCB)	A X 86 X 44 mm

#### 18 x Alman Tipi (Schuko) (DIN 49440) Priz / 128 x Schuko (DIN 49440) Socket

Kod Code	Açıklama Description	Opsiyonlar Options	Ölçüler Size
00006	1 Faz 250 VAC Giriş, IP 20, 32 A, 8.0 kW, (9 + 9) x Alman Tipi (Schuko) (DIN 49440) Priz, 2X16 Otomatik Sigorta, 3G6 mm <sup>2</sup> IEC309-1P 32A fişli siyah kablo	2X16A Oto. Sigorta(MCB)	A X 86 X 44 mm

#### 18 x Fransız Tipi (NF C 61314) Priz / 18 x French (NF C 61314) Socket

Kod Code	Açıklama Description	Opsiyonlar Options	Ölçüler Size
00007	1 Faz 250 VAC Giriş, IP 20, 32 A, 8.0 kW, (9 + 9) x Fransız Tipi Priz, 2X16 Otomatik Sigorta, 3G6 mm <sup>2</sup> IEC309-1P 32A fişli siyah kablo	2X16A Oto. Sigorta(MCB)	A X 86 X 44 mm

#### 18 x IEC320 C13 Priz / 18 x IEC320 C13 Socket

Kod Code	Açıklama Description	Opsiyonlar Options	Ölçüler Size
00008	1 Faz 250 VAC Giriş, IP 20, 32 A, 8.0 kW, (9 + 9) x C13 Priz, 2X16 Otomatik Sigorta, 3G6mm <sup>2</sup> IEC309-1P 32A fişli siyah kablo	2X16A Oto. Sigorta(MCB)	A X 86 X 44 mm

A= Kabin boyuna göre değişkenlik gösterebilir. / Length varies according to rack cabinet length

## BASIC PDU

0U Dikey Tip / 0U Vertical



**16 x IEC320 C13 Priz + 2 x IEC320 C19 Priz / 16 x IEC320 C13 Socket + 2 x IEC320 C19 Socket**

Kod Code	Açıklama Description	Opsiyonlar Options	Ölçüler Size
00009	1 Faz 400 VAC Giriş IP 20, 32 A, 8.0 kW, (8+8) x C13 Socket + (1+1) x C19 Socket , 2X16 Circuit Breaker, 3G6mm <sup>2</sup> black cord with IEC309-1P 32A plug	2X16A Oto. Sigorta(MCB)	A X 86 X 44 mm

**(8 + 8 + 8) x Alman Tipi (Schuko) (DIN 49440) Priz / (8 + 8 + 8) x Schuko (DIN 49440) Socket**

Kod Code	Açıklama Description	Opsiyonlar Options	Ölçüler Size
00010	3 Faz 400 VAC Giriş, IP 20, 16 A, 12 kW, (8+8+8) x Alman Tipi (DIN 49440) Priz, 3X16A Otomatik Sigorta, 5G2.5 mm <sup>2</sup> IEC309-3P 16A fişli siyah kablo	3X16A Oto. Sigorta(MCB)	A X 86 X 44 mm

**(8 + 8 + 8) x Fransız Tipi (NF C 61314) Priz / (8 + 8 + 8) x French Type (NF C 61314) Socket**

Kod Code	Açıklama Description	Opsiyonlar Options	Ölçüler Size
00011	3 Faz 400 VAC Giriş IP 20, 16 A, 12 kW, (8+8+8) x Fransız Tipi Priz, 3X16A Otomatik Sigorta, 5G2.5 mm <sup>2</sup> IEC309-3P 16A fişli siyah kablo	3X16A Oto. Sigorta(MCB)	A X 86 X 44 mm

**(8 + 8 + 8) x IEC320 C13 Priz / (8 + 8 + 8) x IEC320 C13 Socket**

Kod Code	Açıklama Description	Opsiyonlar Options	Ölçüler Size
00012	3 Faz 400 VAC Giriş, IP 20, 16 A, 12 kW, (8+8+8) X IEC320 C13 Priz, 3X16A Otomatik Sigorta, 5G2.5 mm <sup>2</sup> IEC309-3P 16A fişli siyah kablo	3X16A Oto. Sigorta(MCB)	A X 86 X 44 mm

**(6 + 6 + 6) x IEC320 C13 Priz + (2 + 2 + 2) x IEC320 C19 Priz / (6 + 6 + 6) x IEC320 C13 Socket + (2 + 2 + 2) x IEC320 C19 Socket**

Kod Code	Açıklama Description	Opsiyonlar Options	Ölçüler Size
00013	3 Faz 400 VAC Giriş, IP 20, 16 A, 12 kW, (6+6+6) X IEC320 C13 Priz + (2+2+2) x IEC320 C19 Priz, 3X16A Otomatik Sigorta, 5G2.5 mm <sup>2</sup> IEC309-3P 16A fişli siyah kablo	3X16A Oto. Sigorta(MCB)	A X 86 X 44 mm

A= Kabin boyuna göre değişkenlik gösterebilir. / Length varies according to rack cabinet length



## METERED PDU

19" 1U Yatay Tip / 19" 1U Horizontal



### 6 x Alman Tipi (Schuko) (DIN 49440) Priz / 6 x Schuko (DIN 49440) Socket

Kod Code	Açıklama Description	Opsiyonlar Options	Ölçüler Size
11034	1 Faz 250 VAC Giriş, IP20, 16 A, 3.5 kW, 6 x Alman Tipi (schuko) (DIN 49440) Priz, Dijital Ölçüm (V,I,P,PF), H05VV-F 3G1,5 mm <sup>2</sup> Alman Tipi Schuko DIN 49441 fişli siyah kablo	Dijital Ölçüm (V,I,P,PF)	482 X 44 X 44 mm

### 6 x Fransız Tipi (NF C 61314) Priz / 6 x French Type (NF C 61314) Socket

Kod Code	Açıklama Description	Opsiyonlar Options	Ölçüler Size
11035	1 Faz 250 VAC Giriş, IP20, 16 A, 3.5 kW, 6 x Fransız Tipi Priz, Dijital Ölçüm (V,I,P,PF), H05VV-F 3G1,5 mm <sup>2</sup> Alman Tipi Schuko DIN 49441 fişli siyah kablo	Dijital Ölçüm (V,I,P,PF)	482 X 44 X 44 mm

### 4 x İngiliz Tipi (BS 1363) Priz / 4 x British Type (BS 1363) Socket

Kod Code	Açıklama Description	Opsiyonlar Options	Ölçüler Size
11036	1 Faz 250 VAC Giriş, IP20, 13 A, 2.8 Kw, 4 x İngiliz Tipi (BS 1363) Priz, Dijital Ölçüm (V,I,P,PF), H05VV-F 3G1,5 mm <sup>2</sup> 13A sigortalı İngiliz Tip (BS 1363) fişli siyah kablo	Dijital Ölçüm (V,I,P,PF)	482 X 44 X 44 mm

### 8 x IEC320 C13 Priz / 8 x IEC320 C13 Socket

Kod Code	Açıklama Description	Opsiyonlar Options	Ölçüler Size
11037	1 Faz 250 VAC Giriş, IP20, 10 A, 2.5 kW, 8 x IEC320 C13 Priz, Dijital Ölçüm (V,I,P,PF), H05VV-F 3G1,0 mm <sup>2</sup> IEC-C14 fişli siyah kablo	Dijital Ölçüm (V,I,P,PF)	482 X 44 X 44 mm
11038	1 Faz 250 VAC Giriş IP20, 16 A, 4.0 kW, 8 x IEC320 C13 Priz, Dijital Ölçüm (V,I,P,PF), H05VV-F 3G1,5 mm <sup>2</sup> fişli siyah kablo	Dijital Ölçüm (V,I,P,PF)	482 X 44 X 44 mm

## METERED PDU

19" 2U Yatay Tip / 19" 2U Horizontal



### 9 x Alman Tipi (Schuko) (DIN 49440) Priz / 9 x Schuko (DIN 49440) Socket

Kod Code	Açıklama Description	Opsiyonlar Options	Ölçüler Size
20028	1 Faz 250 VAC Giriş, IP20, 16 A, 4.0 kW, 9 x Alman Tipi (DIN 49440) Priz, Dijital Ölçüm (V,I,P,PF), H05VV-F 3G1,5 mm <sup>2</sup> Alman Tipi Schuko DIN 49441 fişli siyah kablo	Dijital Ölçüm (V,I,P,PF)	482 X 44 X 88 mm
20029	1 Faz 250 VAC Giriş, IP20, 16 A, 4.0 kW, 9 x Alman Tipi (DIN 49440) Priz, 1X16A Otomatik Sigorta , ADijital Ölçüm (V,I,P,PF), H05VV-F 3G1,5 mm <sup>2</sup> Alman Tipi Schuko DIN 49441 fişli siyah kablo	1X16A Oto. Sigorta(MCB), Dijital Ölçüm (V,I,P,PF)	482 X 86 X 88 mm

### 9 x Fransız Tipi (NF C 61314) Priz / 9 x French Type (NF C 61314) Socket

Kod Code	Açıklama Description	Opsiyonlar Options	Ölçüler Size
20030	1 Faz 250 VAC Giriş, IP20, 16 A, 4.0 kW, 9 x Fransız Tipi Priz, Dijital Ölçüm (V,I,P,PF), H05VV-F 3G1,5 mm <sup>2</sup> Alman Tipi Schuko DIN 49441 fişli siyah kablo	Dijital Ölçüm (V,I,P,PF)	482 X 44 X 88 mm
20031	1 Faz 250 VAC Giriş, IP20, 16 A, 4.0 kW, 9 x Fransız Tipi Priz, Dijital Ölçüm (V,I,P,PF), H05VV-F 3G1,5 mm <sup>2</sup> Alman Tipi Schuko DIN 49441 fişli siyah kablo	1X16A Oto. Sigorta(MCB), Dijital Ölçüm (V,I,P,PF)	482 X 86 X 88 mm

### 10 x İngiliz Tipi (BS 1363) Priz / 10 x British Type (BS 1363) Socket

Kod Code	Açıklama Description	Opsiyonlar Options	Ölçüler Size
20032	1 Faz 250 VAC Giriş, IP20, 13 A, 3.2 Kw, 10 x İngiliz Tipi (BS 1363) Priz, Dijital Ölçüm (V,I,P,PF), H05VV-F 3G1,5 mm <sup>2</sup> 13A sigortalı İngiliz Tip (BS 1363) fişli siyah kablo	Dijital Ölçüm (V,I,P,PF)	482 X 44 X 88 mm
20033	1 Faz 250 VAC Giriş, IP20, 13 A, 3.2 Kw, 10 x İngiliz Tipi (BS 1363) Priz, Termal Korumalı On/Off Anahtar, Dijital Ölçüm (V,I,P,PF), H05VV-F 3G1,5 mm <sup>2</sup> 13A sigortalı İngiliz Tip (BS 1363) fişli siyah kablo	1X16A Oto. Sigorta(MCB) , Dijital Ölçüm (V,I,P,PF)	482 X 44 X 88 mm

## METERED PDU

OU Dikey Tip / OU Vertical



**(6 + 6) x Alman Tipi (Schuko) (DIN 49440) Priz / (6 + 6) x Schuko (DIN 49440) Socket**

Kod Code	Açıklama Description	Opsiyonlar Options	Ölçüler Size
00014	1 Faz 250 VAC Giriş, IP20, 32A, 8 kW, (6 + 6) x Alman Tipi (schuko) (DIN 49440) Priz, Dijital Ölçüm (V,I,P,PF), 2X16A Otomatik Sigorta, H05VV-F 3G6 mm <sup>2</sup> IEC309-1P 32A fişli siyah kablo	2X16A Oto. Sigorta(MCB), Dijital Ölçüm (V,I,P,PF)	A X 86 X 44 mm

**(6 + 6) x Fransız Tipi (NF C 61314) Priz / (6 + 6) x French Type (NF C 61314) Socket**

Kod Code	Açıklama Description	Opsiyonlar Options	Ölçüler Size
00015	1 Faz 250 VAC Giriş, IP20, 32 A, 8 kW, (6 + 6) x Fransız Tipi Priz, Dijital Ölçüm (V,I,P,PF), 2X16A Otomatik Sigorta, H05VV-F 3G6 mm <sup>2</sup> IEC309-1P 32A fişli siyah kablo	2X16A Oto. Sigorta(MCB), Dijital Ölçüm (V,I,P,PF)	A X 86 X 44 mm

**(6 + 6) x IEC320 C13 Priz / (6 + 6) x IEC320 C13 Socket**

Kod Code	Açıklama Description	Opsiyonlar Options	Ölçüler Size
00016	1 Faz 250 VAC Giriş, IP20, 32 A, 8 kW, (6 + 6) X IEC320 C13 Priz, Dijital Ölçüm (V,I,P,PF), 2X16A Otomatik Sigorta, H05VV-F 3G6 mm <sup>2</sup> IEC309-1P 32A fişli siyah kablo	2X16A Oto. Sigorta(MCB), Dijital Ölçüm (V,I,P,PF)	A X 86 X 44 mm

**(4 + 4) x IEC320 C13 Priz+ (2+2) x IEC320 C19 Priz / (4 + 4) x IEC320 C13 Socket+ (2+2) x IEC320 C19 Socket**

Kod Code	Açıklama Description	Opsiyonlar Options	Ölçüler Size
00017	1 Faz 250 VAC Giriş, IP20, 32 A, 8 kW, (6 + 6) X IEC320 C13 Priz, Dijital Ölçüm (V,I,P,PF), 2X16A Otomatik Sigorta, H05VV-F 3G6 mm <sup>2</sup> IEC309-1P 32A fişli siyah kablo	2X16A Oto. Sigorta(MCB), Dijital Ölçüm (V,I,P,PF)	A X 86 X 44 mm

**(9 + 9) x Alman Tipi (Schuko) (DIN 49440) Priz / (9 + 9) x Schuko (DIN 49440) Socket**

Kod Code	Açıklama Description	Opsiyonlar Options	Ölçüler Size
00018	1 Faz 250 VAC Giriş, IP 20, 32A, 8kW, (9 + 9) x Alman Tipi (DIN 49440) Priz, Dijital Ölçüm (V,I,P,PF), 2X16A Otomatik Sigorta, H05VV-F 3G6 mm <sup>2</sup> IEC309-1P 32A fişli siyah kablo	2X16A Oto. Sigorta(MCB), Dijital Ölçüm (V,I,P,PF)	A X 86 X 44 mm

**(9 + 9) x Fransız Tipi (NF C 61314) Priz / (9 + 9) x French Type (NF C 61314) Socket**

Kod Code	Açıklama Description	Opsiyonlar Options	Ölçüler Size
00019	1 Faz 250 VAC Giriş, IP 20, 32A, 8kW, (9 + 9) x Fransız Tipi Priz, Dijital Ölçüm (V,I,P,PF), 2X16A Otomatik Sigorta, H05VV-F 3G6 mm <sup>2</sup> IEC309-1P 32A fişli siyah kablo	2X16A Oto. Sigorta(MCB), Dijital Ölçüm (V,I,P,PF)	A X 86 X 44 mm

A= Kabin boyuna göre değişkenlik gösterebilir. / Length varies according to rack cabinet length

## METERED PDU

OU Dikey Tip / OU Vertical



(12 + 12) x C13 Priz / (12 + 12) x C13 Socket

Kod Code	Açıklama Description	Opsiyonlar Options	Ölçüler Size
00020	1 Faz 250 VAC Giriş, IP 20, 32A, 8kW, (9 + 9) x Alman Tipi (DIN 49440) Priz, Dijital Ölçüm (V,I,P,PF), 2X16A Otomatik Sigorta, H05VV-F 3G6 mm <sup>2</sup> IEC309-1P 32A fişli siyah kablo	2X16A Oto. Sigorta(MCB), Dijital Ölçüm (V,I,P,PF)	A X 86 X 44 mm

(10 + 10) x C13 Priz + (2 + 2) x C19 Priz / (10 + 10) x C13 Socket + (2 + 2) x C19 Socket

Kod Code	Açıklama Description	Opsiyonlar Options	Ölçüler Size
00021	1 Faz 250 VAC Giriş, IP 20, 32A, 8kW, (10+10) x IEC320 C13 Priz + (2+2) x IEC320 C19 Priz, Dijital Ölçüm (V,I,P,PF), 2X16A Otomatik Sigorta, H05VV-F 3G6 mm <sup>2</sup> IEC309-1P 32A fişli siyah kablo	2X16A Oto. Sigorta(MCB), Dijital Ölçüm (V,I,P,PF)	A X 86 X 44 mm

(8 + 8 + 8) x Alman Tipi (Schuko) (DIN 49440) Priz / (8 + 8 + 8) x Schuko (DIN 49440) Socket

Kod Code	Açıklama Description	Opsiyonlar Options	Ölçüler Size
00022	3 Faz 400 VAC Giriş, IP 20, 16A, 12kW, (8+8+8) x Alman Tipi (DIN 49440) Priz, 3XDijital Ölçüm (V,I,P,PF), 3X16A Otomatik Sigorta, H05VV-F 5G2.5 mm <sup>2</sup> IEC309-3P 16A fişli siyah kablo	3X16A Oto. Sigorta(MCB), 3XDijital Ölçüm (V,I,P,PF)	A X 86 X 44 mm

(8 + 8 + 8) x Fransız Tipi (NF C 61314) Priz / (8 + 8 + 8) x French Type (NF C 61314) Socket

Kod Code	Açıklama Description	Opsiyonlar Options	Ölçüler Size
00023	3 Faz 400 VAC Giriş, IP 20, 16A, 12kW, (8+8+8) x Fransız Tipi Priz, 3XDijital Ölçüm (V,I,P,PF), 3X16A Otomatik Sigorta, H05VV-F 5G2.5 mm <sup>2</sup> IEC309-3P 16A fişli siyah kablo	3X16A Oto. Sigorta(MCB), 3XDijital Ölçüm (V,I,P,PF)	A X 86 X 44 mm

(8 + 8 + 8) x IEC320 C13 Priz / (8 + 8 + 8) x IEC320 C13 Socket

Kod Code	Açıklama Description	Opsiyonlar Options	Ölçüler Size
00024	3 Faz 400 VAC Giriş, IP 20, 16A, 12kW, (8+8+8) X IEC320 C13 Priz, 3XDijital Ölçüm (V,I,P,PF), 3X32A Otomatik Sigorta, H05VV-F 5G2.5 mm <sup>2</sup> IEC309-3P 16A fişli siyah kablo	3X16A Oto. Sigorta(MCB), 3XDijital Ölçüm (V,I,P,PF)	A X 86 X 44 mm

(6 + 6 + 6) x IEC320 C13 Priz + (2 + 2 + 2) x IEC320 C19 Priz / (6 + 6 + 6) x IEC320 C13 Socket + (2 + 2 + 2) x IEC320 C19 Socket

Kod Code	Açıklama Description	Opsiyonlar Options	Ölçüler Size
00025	3 Faz 400 VAC Giriş, IP 20, 16A, 12kW, (6+6+6) X IEC320 C13 Priz + (2+2+2) x IEC320 C19 Priz, 3XDijital Ölçüm (V,I,P,PF), 3X16A Otomatik Sigorta, H05VV-F 5G2.5 mm <sup>2</sup> IEC309-3P 16A fişli siyah kablo	3X16A Oto. Sigorta(MCB), 3XDijital Ölçüm (V,I,P,PF)	A X 86 X 44 mm



## IP PDU



### 19" 1U Yatay Tip / 19" 1U Horizontal

**6 x IEC320 C13 Priz / 6 x IEC320 C13 Socket**

Kod Code	Açıklama Description	Opsiyonlar Options	Ölçüler Size
11039	1 Faz 250 VAC Giriş IP20, 16 A, 4 kW, 8 x IEC320 C13 Priz, Toplam Güç ve Enerji İzleme, H05VV-F 3G1,5 mm <sup>2</sup> siyah kablo	Toplam Güç ve Enerji İzleme	482 X 67 X 44 mm

### 19" 2U Yatay Tip / 19" 2U Horizontal

**10 x IEC320 C13 Priz / 10 x IEC320 C13 Socket**

Kod Code	Açıklama Description	Opsiyonlar Options	Ölçüler Size
20034	1 Faz 250 VAC Giriş, IP20, 16 A, 4 kW, 10 x IEC320 C13 Priz, 1X16A Otomatik Sigorta, Toplam Güç ve Enerji İzleme, H05VV-F 3G1,5 mm <sup>2</sup> siyah kablo	Toplam Güç ve Enerji İzleme 1X16A Oto. Sigorta(MCB)	482 X 67 X 88 mm

### 0U Dikey Tip / 0U Vertical

**1 Faz (10 + 10) x IEC320 C13 Priz + (2 + 2) x IEC320 C19 Priz / 1 Phase (10 + 10) x IEC320 C13 Socket + (2 + 2) x IEC320 C19 Socket**

Kod Code	Açıklama Description	Opsiyonlar Options	Ölçüler Size
00026	1 Faz 400 VAC Giriş, IP 20, 32 A, 8 kW, (10+10) X IEC320 C13 Priz + (2+2) x IEC320 C19 Priz, Toplam Güç ve Enerji İzleme, 2X16A Otomatik Sigorta, H05VV-F 3G6 mm <sup>2</sup> IEC309-1P 32A fişli siyah kablo	Toplam Güç ve Enerji İzleme 1X16A Oto. Sigorta(MCB)	A X 86 X 44 mm

**1 Faz (12 + 12) x Alman Tipi (Schuko) (DIN 49440) Priz / 1 Phase (12 + 12) x Schuko (DIN 49440) Socket**

Kod Code	Açıklama Description	Opsiyonlar Options	Ölçüler Size
00027	1 Faz 400 VAC Giriş, IP 20, 32 A, 8 kW, (10+10) X IEC320 C13 Priz + (2+2) x IEC320 C19 Priz, Toplam Güç ve Enerji İzleme, 2X16A Otomatik Sigorta, H05VV-F 3G6 mm <sup>2</sup> IEC309-1P 32A fişli siyah kablo	Toplam Güç ve Enerji İzleme 2X16A Oto. Sigorta(MCB)	A X 86 X 44 mm

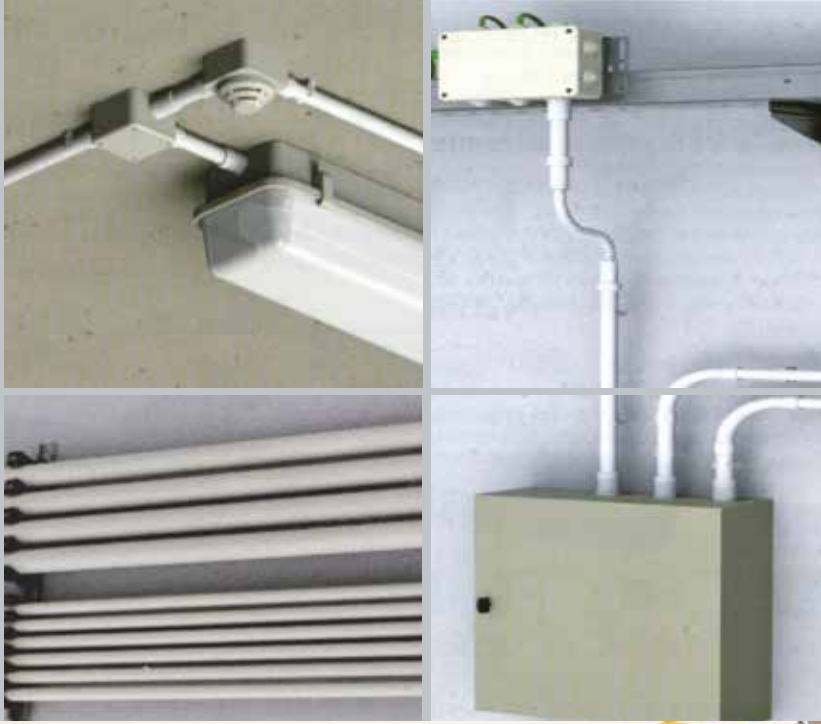

**E**LEKTRİK TESİSAT BORULARI  
ELECTRICAL INSTALLATION CONDUITS



**ELEKTRİK TESİSAT BORULARI**  
**ELECTRICAL INSTALLATION CONDUITS****PVC Düz Boru / PVC Rigid Conduit**  
**Hafif Seri / Light Gauge****Alev Yayımayan - Yayla Bükülebilir TesiSat Borusu**

DLX 801 Kullanım Alanları: Mekanik zorlamaların fazla olmadığı yerlerde, sıva altı ve sıva üstünde, alçıpan, duvar yada asma tavan içinde ve yükseltilmiş döşeme uygulamalarında.

**Self Extinguishing - Malleable Rigid Conduit**

**DLX 801 Field of Application:** Used in applications on walls, under the plaster; in all kinds of concrete floor and ceiling slabs, on suspended ceilings and under areas where low mechanical shocks and loadings are expected and also available for raised floor.

**Renk Kod No**  
**Color Code**

Siyah  
Black  
Ral 9005



Gri  
Grey  
Ral 7035



Beyaz  
White  
Ral 9016

**PVC DÜZ BORU / PVC RIGID CONDUIT**

Ürün Kodu Product Code	Dış Çap (mm) Ex. Diameter (mm)	İç Çap (mm) Int. Diameter (mm)	Ambalaj Packaging
DLX 801 16	Ø 16	13,6	102 m
DLX 801 20	Ø 20	17,4	102 m
DLX 801 25	Ø 25	22,1	51 m
DLX 801 32	Ø 32	28,6	45 m
DLX 801 40	Ø 40	36,7	30 m

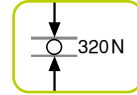
**Teknik Özellikler**

Standart	: EN 61386-21 / 22
Malzeme	: PVC Bazlı Termoplastik
Sıkıştırma Dayanımı	: 320 Newton / 60 sn./sec / 23± 2°C
Darbe Dayanımı	: 1 kg. / 100 mm / -25°C
Çalışma Ortamı Sıcaklığı	: - 25°C + 60°C
Yalıtım Gerilimi	: 2000 V. / 50 Hz. / 15 dak.
Kendiliğinden Sönen PVC Malzeme	: UL94 V0
Boru Boyu	: 3 m.

**Technical Details**

Standard	: EN 61386-21 / 22
Material	: PVC Based Thermoplastic
Compression Resistance	: 320 Newton / 60 sn./sec / 23± 2°C
Impact Resistance	: 1 kg. / 100 mm / -25°C
Working Temperature	: - 25°C + 60°C
Insulating Strength	: 2000 V. / 50 Hz. / 15 min.
PVC Material (Self Extinguishing)	: UL94 V0
Conduit Length	: 3 m.

## ELEKTRİK TESİSAT BORULARI ELECTRICAL INSTALLATION CONDUITS



### PVC Düz Boru / PVC Rigid Conduit Orta Seri / Medium Gauge

#### Alev Yayımayan - Yayla Bükülebilir Tesiilat Borusu

DLX 802 Kullanım Alanları: Mekanik zorlamaların fazla olmadığı yerlerde, sıva altı ve sıva üstünde, alçıpan, duvar yada asma tavan içinde ve yükseltilmiş döşeme uygulamalarında.

#### Self Extinguishing - Malleable Rigid Conduit

**DLX 802 Field of Application:** Used in applications on walls, under the plaster; in all kinds of concrete floor and ceiling slabs, on suspended ceilings and under areas where low mechanical shocks and loadings are expected and also available for raised floor.

#### Renk Kod No Color Code



Siyah  
Black  
Ral 9005



Gri  
Grey  
Ral 7035



Beyaz  
White  
Ral 9016

### PVC DÜZ BORU / PVC RIGID CONDUIT

Ürün Kodu Product Code	Dış Çap (mm) Ex. Diameter (mm)	İç Çap (mm) Int. Diameter (mm)	Ambalaj Packaging
DLX 802 16	Ø 16	13,1	102 m
DLX 802 20	Ø 20	16,9	102 m
DLX 802 25	Ø 25	21,6	51 m
DLX 802 32	Ø 32	27,8	45 m
DLX 802 40	Ø 40	35,6	30 m

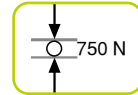

#### Teknik Özellikler

Standart	: EN 61386-21 / 22
Malzeme	: PVC Bazlı Termoplastik
Sıkıştırma Dayanımı	: 750 Newton / 60 sn./sec / 23± 2°C
Darbe Dayanımı	: 1 kg. / 100 mm / -25°C
Çalışma Ortamı Sıcaklığı	: - 25°C + 60°C
Yalıtım Gerilimi	: 2000 V. / 50 Hz. / 15 dak.
Kendiliğinden Sönen PVC Malzeme	: UL94 V0
Boru Boyu	: 3 m.

#### Technical Details

Standard	: EN 61386-21 / 22
Material	: PVC Based Thermoplastic
Compression Resistance	: 750 Newton / 60 sn./sec / 23± 2°C
Impact Resistance	: 1 kg. / 100 mm / -25°C
Working Temperature	: - 25°C + 60°C
Insulating Strength	: 2000 V. / 50 Hz. / 15 min.
PVC Material (Self Extinguishing)	: UL94 V0
Conduit Length	: 3 m.

**ELEKTRİK TESİSAT BORULARI**  
**ELECTRICAL INSTALLATION CONDUITS****Muflu PVC Düz Boru / Sleeved PVC Rigid Conduit**  
**Hafif Seri / Light Gauge****Alev Yayımayan - Yayla Bükülebilen Tesisat Borusu**

DLX 804 Kullanım Alanları: Mekanik zorlamaların fazla olmadığı yerlerde, sıva altı ve sıva üstünde, alçıpan, duvar yada asma tavan içinde ve yükseltilmiş döşeme uygulamalarında.

**Self Extinguishing - Malleable Rigid Conduit**

**DLX 804 Field of Application:** Used in applications on walls, under the plaster; in all kinds of concrete floor and ceiling slabs, on suspended ceilings and under areas where low mechanical shocks and loadings are expected and also available for raised floor.

**Renk Kod No**  
**Color Code**

Siyah  
Black  
Ral 9005



Gri  
Grey  
Ral 7035



Beyaz  
White  
Ral 9016

**PVC DÜZ BORU / PVC RIGID CONDUIT**

Ürün Kodu Product Code	Dış Çap (mm) Ex. Diameter (mm)	İç Çap (mm) Int. Diameter (mm)	Ambalaj Packaging
DLX 804 16	Ø 16	13,6	102 m
DLX 804 20	Ø 20	17,4	102 m
DLX 804 25	Ø 25	22,1	51 m
DLX 804 32	Ø 32	28,6	45 m
DLX 804 40	Ø 40	36,7	30 m

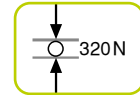
**Teknik Özellikler**

Standart	: EN 61386-21 / 22
Malzeme	: PVC Bazlı Termoplastik
Sıkıştırma Dayanımı	: 320 Newton / 60 sn./sec / 23± 2°C
Darbe Dayanımı	: 1 kg. / 100 mm / -25°C
Çalışma Ortamı Sıcaklığı	: - 25°C + 60°C
Yalıtım Gerilimi	: 2000 V. / 50 Hz. / 15 dak.
Kendiliğinden Sönen PVC Malzeme	: UL94 V0
Boru Boyu	: 3 m.

**Technical Details**

Standard	: EN 61386-21 / 22
Material	: PVC Based Thermoplastic
Compression Resistance	: 320 Newton / 60 sn./sec / 23± 2°C
Impact Resistance	: 1 kg. / 100 mm / -25°C
Working Temperature	: - 25°C + 60°C
Insulating Strength	: 2000 V. / 50 Hz. / 15 min.
PVC Material (Self Extinguishing)	: UL94 V0
Conduit Length	: 3 m.

## ELEKTRİK TESİSAT BORULARI ELECTRICAL INSTALLATION CONDUITS



### Mufli PVC Düz Boru / Sleeved PVC Rigid Conduit Orta Seri / Medium Gauge

#### Alev Yayımayan - Yayla Bükülebilir TesiSat Borusu

DLX 805 Kullanım Alanları: Mekanik zorlamaların fazla olmadığı yerlerde, sıva altı ve sıva üstünde, alçıpan, duvar yada asma tavan içinde ve yükseltilmiş döşeme uygulamalarında.

#### Self Extinguishing - Malleable Rigid Conduit

**DLX 805 Field of Application:** Used in applications on walls, under the plaster; in all kinds of concrete floor and ceiling slabs, on suspended ceilings and under areas where low mechanical shocks and loadings are expected and also available for raised floor.

#### Renk Kod No Color Code



Siyah  
Black  
Ral 9005



Gri  
Grey  
Ral 7035



Beyaz  
White  
Ral 9016

### PVC DÜZ BORU / PVC RIGID CONDUIT

Ürün Kodu Product Code	Dış Çap (mm) Ex. Diameter (mm)	İç Çap (mm) Int. Diameter (mm)	Ambalaj Packaging
DLX 805 16	Ø 16	13,1	102 m
DLX 805 20	Ø 20	16,9	102 m
DLX 805 25	Ø 25	21,6	51 m
DLX 805 32	Ø 32	27,8	45 m
DLX 805 40	Ø 40	35,6	30 m



#### Teknik Özellikler

Standart	: EN 61386-21 / 22
Malzeme	: PVC Bazlı Termoplastik
Sıkıştırma Dayanımı	: 750 Newton / 60 sn./sec / 23± 2°C
Darbe Dayanımı	: 1 kg. / 100 mm / -25°C
Çalışma Ortamı Sıcaklığı	: - 25°C + 60°C
Yalıtım Gerilimi	: 2000 V. / 50 Hz. / 15 dak.
Kendiliğinden Sönen PVC Malzeme	: UL94 V0
Boru Boyu	: 3 m.

#### Technical Details

Standard	: EN 61386-21 / 22
Material	: PVC Based Thermoplastic
Compression Resistance	: 750 Newton / 60 sn./sec / 23± 2°C
Impact Resistance	: 1 kg. / 100 mm / -25°C
Working Temperature	: - 25°C + 60°C
Insulating Strength	: 2000 V. / 50 Hz. / 15 min.
PVC Material (Self Extinguishing)	: UL94 V0
Conduit Length	: 3 m.

## DÜZ BORU BAĞLANTI AKSESUARLARI / CONDUIT INSTALLATIONS ACCESSORIES



### Ek Mufu / Coupling

Ürün Kodu Product Code	Çap Diameter	Ambalaj Packaging
DLX 811 16	Ø 16	100 Ad./Pcs.
DLX 811 20	Ø 20	100 Ad./Pcs.
DLX 811 25	Ø 25	100 Ad./Pcs.
DLX 811 32	Ø 32	100 Ad./Pcs.



### Dirsek / Bending Piece

Ürün Kodu Product Code	Çap Diameter	Ambalaj Packaging
DLX 821 16	Ø 16	100 Ad./Pcs.
DLX 821 20	Ø 20	100 Ad./Pcs.
DLX 821 25	Ø 25	100 Ad./Pcs.
DLX 821 32	Ø 32	100 Ad./Pcs.

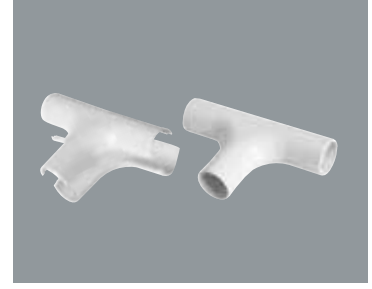

### T Eki / T Corner

Ürün Kodu Product Code	Çap Diameter	Ambalaj Packaging
DLX 831 16	Ø 16	100 Ad./Pcs.
DLX 831 20	Ø 20	100 Ad./Pcs.
DLX 831 25	Ø 25	100 Ad./Pcs.
DLX 831 32	Ø 32	100 Ad./Pcs.



### Ay Kroşe / Snap Clip

Ürün Kodu Product Code	Çap Diameter	Ambalaj Packaging
DLX 841 16	Ø 16	500 Ad./Pcs.
DLX 841 20	Ø 20	500 Ad./Pcs.
DLX 841 25	Ø 25	500 Ad./Pcs.
DLX 841 32	Ø 32	500 Ad./Pcs.



### PVC Düz Boru Rakoru PVC Rigid Pipe Adapter

Ürün Kodu Product Code	Çap Diameter	Ambalaj Packaging
DLX 875 16	Ø 16	100 Ad./Pcs.
DLX 875 20	Ø 20	100 Ad./Pcs.
DLX 875 25	Ø 25	100 Ad./Pcs.
DLX 875 32	Ø 32	100 Ad./Pcs.

## ANAHTAR PRİZ KASALARI / SWITCH AND PLUG BOXES



### Alçıpan Duvar Kasası Hollow Wall Switch Box

Ürün Kodu Product Code	Açıklama Description	Ambalaj Packaging
880 15	Holojen Free / Halogen Free	500
880 16	Alev Yaymayan / HF Self Extinguishing	500



### Sıva Altı Derin Geçmeli Kasa Flush Mounting Deep One Gang Switch Box

Ürün Kodu Product Code	Açıklama Description	Ambalaj Packaging
880 17	Holojen Free / Halogen Free	500
880 18	Alev Yaymayan / HF Self Extinguishing	500



### Sıva Altı Modüler Kasa Flush Mounting Module Case

Ürün Kodu Product Code	Açıklama Description	Ambalaj Packaging
880 19	Holojen Free / Halogen Free	500



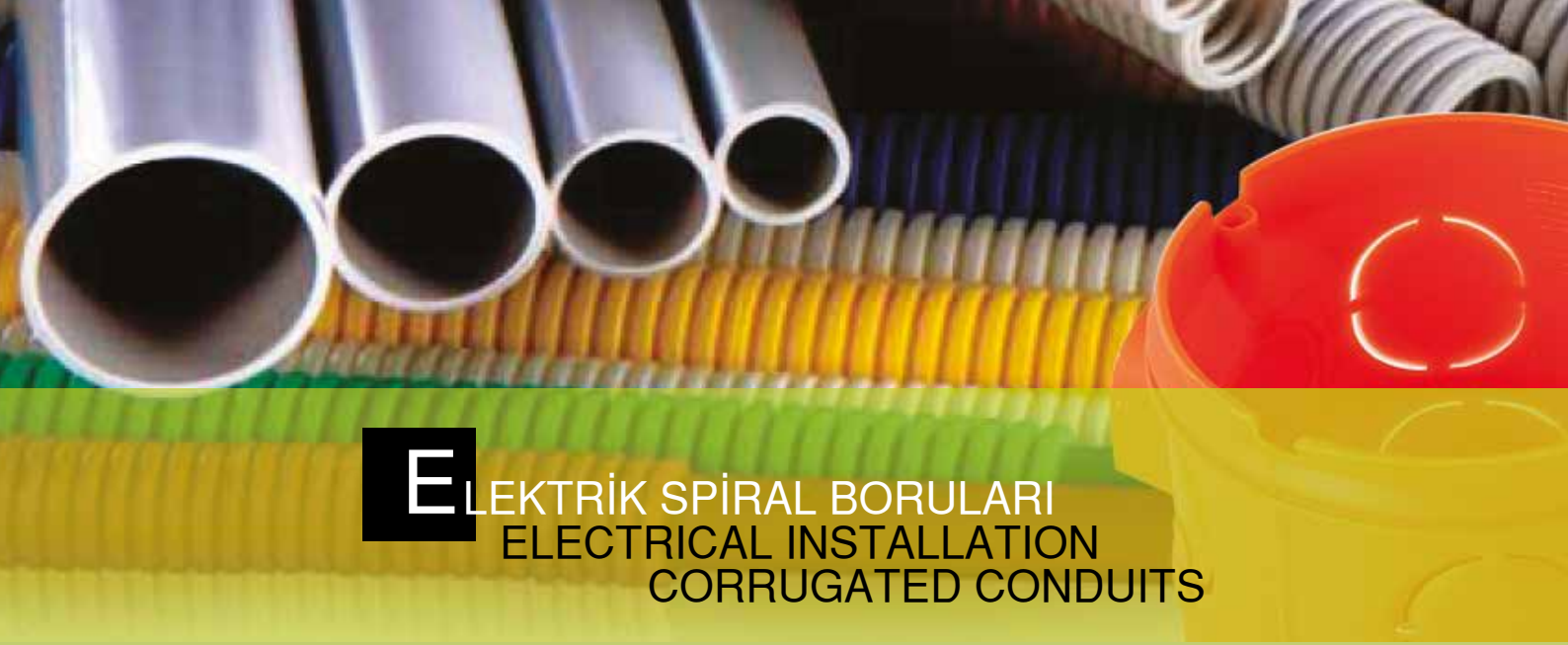
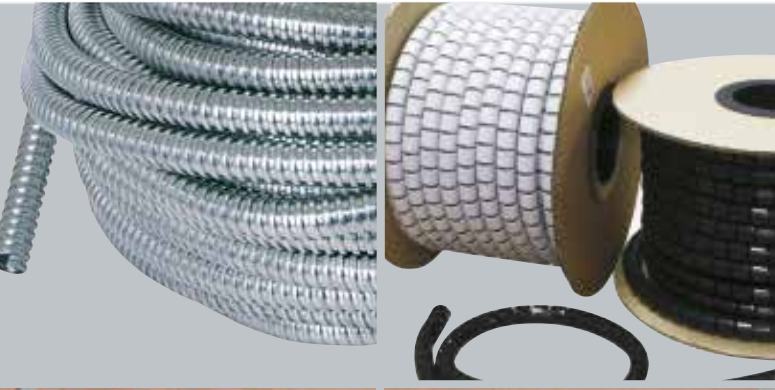

**E**LEKTRİK SİRİRAL BORULARI  
ELECTRICAL INSTALLATION  
CORRUGATED CONDUITS

**ELEKTRİK TESİSAT BORULARI**  
**ELECTRICAL INSTALLATION CONDUITS****PE Spiral Boru**  
**PE Corrugated Conduit****Halojeniz**

**DLX 840 Kullanım Alanları:** Her türlü elektrik tesisatında mekanik zorlamaların fazla olmadığı yerlerde, bina, prefabrik yapılarda, sıva altı ve sıva üstü tüm uygulamalarda, beton içerisinde, alçıpan, duvar ya da asma tavan içerisinde, özellikle tünel kalıp sistemlerinde ve yükseltilmiş döşeme uygulamalarında.

**Halogen free**

**DLX 840 Field of Application:** Used in applications on walls, under the plaster; in all kinds of concrete floor and ceiling slabs, on suspended ceilings and under areas where low mechanical shocks and loadings are expected and also available for raised floor.

**Renk Kod No / Color Code**

Siyah  
Black  
Ral 9005



Gri  
Grey  
Ral 7035



Mavi  
Blue  
Ral 5017



Turuncu  
Orange  
Ral 2004



Beyaz  
White  
Ral 9016

**PE SİRİAL BORU / PE CORRUGATED CONDUIT**

Ürün Kodu Product Code	Dış Çap (mm) Ex. Diameter (mm)	İç Çap (mm) Int. Diameter (mm)	Ambalaj / m Package / m
DLX 840 16	Ø 16	11,2	100
DLX 840 20	Ø 20	14,5	100
DLX 840 25	Ø 25	19,0	50
DLX 840 32	Ø 32	24,8	50
DLX 840 40	Ø 40	32,20	25

**Teknik Özellikler**

Standart	: EN 61386-21 / 22
Malzeme	: PE Bazlı Termoplastik
Sıkıştırma Dayanımı	: 750 Newton / 60 sn./sec / 23± 2°C
Darbe Dayanımı	: 2 kg. / 100 mm / -25°C
Çalışma Ortamı Sıcaklığı	: - 25°C + 60°C
Yalıtım Gerilimi	: 2000 V. / 50 Hz. / 15 dak.

**Technical Details**

Standard	: EN 61386-21 / 22
Material	: PE Based Thermoplastic
Compression Resistance	: 750 Newton / 60 sn./sec / 23± 2°C
Impact Resistance	: 2 kg. / 100 mm / -25°C
Working Temperature	: - 25°C + 60°C
Insulating Strength	: 2000 V. / 50 Hz. / 15 min.

## ELEKTRİK TESİSAT BORULARI ELECTRICAL INSTALLATION CONDUITS



DLX 860

### PP Spiral Boru PP Corrugated Conduit





#### Halojensiz Alev Yayımayan

**DLX 860 Kullanım Alanları:** Her türlü elektrik tesisatında mekanik zorlamaların fazla olmadığı yerlerde, bina, prefabrik yapılarda, sıva altı ve sıva üstü tüm uygulamalarda, beton içerisinde, alçıpan, duvar ya da asma tavan içerisinde, özellikle tünel kalıp sistemlerinde ve yükseltilmiş döşeme uygulamalarında.

#### Self Extinguishing Halogen free

**DLX 860 Field of Application:** Used in applications on walls, under the plaster; in all kinds of concrete floor and ceiling slabs, on suspended ceilings and under areas where low mechanical shocks and loadings are expected and also available for raised floor.

#### Renk Kod No / Color Code

			
Siyah Black Ral 9005	Gri Grey Ral 7035	Mavi Blue Ral 5017	Beyaz White Ral 9016

#### PP SİRİAL BORU / PP CORRUGATED CONDUIT

Ürün Kodu Product Code	Dış Çap (mm) Ex. Diameter (mm)	İç Çap (mm) Int. Diameter (mm)	Ambalaj / m Package / m
DLX 860 16	Ø 16	11,2	100
DLX 860 20	Ø 20	14,5	100
DLX 860 25	Ø 25	19,0	50
DLX 860 32	Ø 32	24,8	50
DLX 860 40	Ø 40	32,20	25

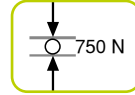

#### Teknik Özellikler

Standart	: EN 61386-21 / 22
Malzeme	: PP Bazlı Termoplastik
Sıkıştırma Dayanımı	: 750 Newton / 60 sn./sec / 23± 2°C
Darbe Dayanımı	: 2 kg. / 100 mm / -25°C
Çalışma Ortamı Sıcaklığı	: - 25°C + 60°C
Yalıtım Gerilimi	: 2000 V. / 50 Hz. / 15 dak.

#### Technical Details

Standard	: EN 61386-21 / 22
Material	: PP Based Thermoplastic
Compression Resistance	: 750 Newton / 60 sn./sec / 23± 2°C
Impact Resistance	: 2 kg. / 100 mm / -25°C
Working Temperature	: - 25°C + 60°C
Insulating Strength	: 2000 V. / 50 Hz. / 15 min.

**ELEKTRİK TESİSAT BORULARI**  
**ELECTRICAL INSTALLATION CONDUITS****DLX 849****PE Spiral Boru Klavuz Telli**  
**PE Corrugated Conduit the guide wire****Halojensiz**

**DLX 849 Kullanım Alanları:** Her türlü elektrik tesisatında mekanik zorlamaların fazla olmadığı yerlerde, bina, prefabrik yapılarda, sıva altı ve sıva üstü tüm uygulamalarda, beton içerisinde, alçıpan, duvar ya da asma tavan içerisinde, özellikle tünel kalıp sistemlerinde ve yükseltilmiş döşeme uygulamalarında.

**Halogen free**

**DLX 849 Field of Application:** Used in applications on walls, under the plaster; in all kinds of concrete floor and ceiling slabs, on suspended ceilings and under areas where low mechanical shocks and loadings are expected and also available for raised floor.

**Renk Kod No / Color Code**

				
Siyah Black Ral 9005	Gri Grey Ral 7035	Mavi Blue Ral 5017	Turuncu Orange Ral 2004	Beyaz White Ral 9016

**PE SİRİAL BORU / PE CORRUGATED CONDUIT**

Ürün Kodu Product Code	Dış Çap (mm) Ex. Diameter (mm)	İç Çap (mm) Int. Diameter (mm)	Ambalaj / m Package / m
DLX 849 16	Ø 16	11,2	100
DLX 849 20	Ø 20	14,5	100
DLX 849 25	Ø 25	19,0	50
DLX 849 32	Ø 32	24,8	50
DLX 849 40	Ø 40	32,20	25

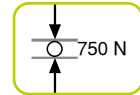
**Teknik Özellikler**

Standart	: EN 61386-21 / 22
Malzeme	: PE Bazlı Termoplastik
Sıkıştırma Dayanımı	: 750 Newton / 60 sn./sec / 23± 2°C
Darbe Dayanımı	: 2 kg. / 100 mm / -25°C
Çalışma Ortamı Sıcaklığı	: - 25°C + 60°C
Yalıtım Gerilimi	: 2000 V. / 50 Hz. / 15 dak.

**Technical Details**

Standard	: EN 61386-21 / 22
Material	: PE Based Thermoplastic
Compression Resistance	: 750 Newton / 60 sn./sec / 23± 2°C
Impact Resistance	: 2 kg. / 100 mm / -25°C
Working Temperature	: - 25°C + 60°C
Insulating Strength	: 2000 V. / 50 Hz. / 15 min.

## ELEKTRİK TESİSAT BORULARI ELECTRICAL INSTALLATION CONDUITS



DLX 869

### PP Spiral Boru Klavuz Telli PP Corrugated Conduit the guide wire

#### Halojensiz Alev Yayımayan

**DLX 869 Kullanım Alanları:** Her türlü elektrik tesisatında mekanik zorlamaların fazla olmadığı yerlerde, bina, prefabrik yapılarda, sıva altı ve sıva üstü tüm uygulamalarda, beton içerisinde, alçıpan, duvar ya da asma tavan içerisinde, özellikle tünel kalıp sistemlerinde ve yükseltilmiş döşeme uygulamalarında.

#### Self Extinguishing Halogen free

**DLX 869 Field of Application:** Used in applications on walls, under the plaster; in all kinds of concrete floor and ceiling slabs, on suspended ceilings and under areas where low mechanical shocks and loadings are expected and also available for raised floor.

#### Renk Kod No / Color Code

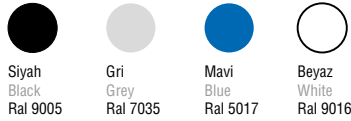

#### PP SİRİAL BORU / PP CORRUGATED CONDUIT

Ürün Kodu Product Code	Dış Çap (mm) Ex. Diameter (mm)	İç Çap (mm) Int. Diameter (mm)	Ambalaj / m Package / m
DLX 869 16	Ø 16	11,2	100
DLX 869 20	Ø 20	14,5	100
DLX 869 25	Ø 25	19,0	50
DLX 869 32	Ø 32	24,8	50
DLX 869 40	Ø 40	32,20	25

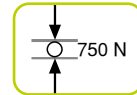

#### Teknik Özellikler

Standart	: EN 61386-21 / 22
Malzeme	: PP Bazlı Termoplastik
Sıkıştırma Dayanımı	: 750 Newton / 60 sn./sec / 23± 2°C
Darbe Dayanımı	: 2 kg. / 100 mm / -25°C
Çalışma Ortamı Sıcaklığı:	- 25°C + 60°C
Yalıtım Gerilimi	: 2000 V. / 50 Hz. / 15 dak.

#### Technical Details

Standard	: EN 61386-21 / 22
Material	: PP Based Thermoplastic
Compression Resistance	: 750 Newton / 60 sn./sec / 23± 2°C
Impact Resistance	: 2 kg. / 100 mm / -25°C
Working Temperature	: - 25°C + 60°C
Insulating Strength	: 2000 V. / 50 Hz. / 15 min.

**ELEKTRİK TESİSAT BORU AKSESUARLARI**  
**ELECTRICAL INSTALLATION CONDUIT ACCESSORIES****Spiral Boru Rakoru**  
**Spiral Pipe Adapter**

Ürün Kodu Product Code	Dış Çap (mm) Ex. Diameter (mm)	İç Çap (mm) Int. Diameter (mm)	Ambalaj / adet Packaging / pcs
DLX 878 16	2,5	10,0-14,0	100
DLX 878 20	3,0	15,0-19,0	100
DLX 878 25	4,4	21,0-25,0	100
DLX 878 32	1,0	28,3-32,3	100

**Spiral Boru Mufu**  
**Spiral Pipe Coupling**

Ürün Kodu Product Code	Dış Çap (mm) Ex. Diameter (mm)	İç Çap (mm) Int. Diameter (mm)	Ambalaj / adet Packaging / pcs
DLX 876 16	1,5	16,4	100
DLX 876 20	1,5	20,5	100
DLX 876 25	2	25,5	100
DLX 876 32	2	32,5	100
DLX 876 40	2	41	100

**Kablo Toplama Spirali**  
**Spiral Cable Wrap**

Ürün Kodu Product Code	İç Çap (mm) Int. Diameter (mm)	Ambalaj / adet Packaging / pcs
DLX 877 20	20 (1,5mt)	1
DLX 877 31	25 (1,5mt)	1
DLX 877 32	30 (1,5mt)	1
DLX 877 33	Aksesuar (20mm)	1

**Kablo Toplama Spirali**  
**Spiral Cable Wrap**

Ürün Kodu Product Code	İç Çap (mm) Int. Diameter (mm)	Ambalaj / m Packaging / m
DLX 877 22	20	25
DLX 877 28	25	20
DLX 877 30	30	15

**KABLO KANAL DÜBELLERİ**  
**CABLE TRUNKING SCREW SOCKETS**

910 10

**Kablo Kanalı Dübeli**  
Cable Trunking Screw Socket  
Ambalaj: 500 Adet  
Packaging: 500m

910 11

**Alçıpan dübeli**  
Screwed Plaster  
Ambalaj: 500 Adet  
Packaging: 500m

910 12

**Dübel 7mm**  
Screw Socket  
Ambalaj: 1000 Adet  
Packaging: 1000m

910 13

**Dübel 8mm**  
Screw Socket  
Ambalaj: 1000 Adet  
Packaging: 1000pcs

910 14

**Kablo kanalı Vidası**  
**5x40mm**  
Cable Trunking Screw 5x40mm  
Ambalaj: 144 Adet  
Packaging: 144 pcs

910 15

**Kablo kanalı Vidası**  
**5x50mm**  
Cable Trunking Screw 5x50mm  
Ambalaj: 144 Adet  
Packaging: 144 pcs

910 16

**Kablo kanalı pulu**  
**3x16 mm**  
Cable Trunking Screw Washer  
Ambalaj: 500 Adet  
Packaging: 500pcs

**ÇELİK SİRALLER  
STEEL TUBES****ÇELİK SİRALLER / STEEL TUBES**

Ürün Kodu Product Code	Nominal Çap Nominal Diameter	İç Çap (mm) Int. Diameter (mm)	Dış Çap (mm) Ex. Diameter (mm)	Ambalaj / adet Packaging / pcs
871 09	Ø 9	9	11,5	50 m
871 11	Ø 11	11	14	50 m
871 14	Ø 14	14	17	50 m
871 16	Ø 16	16	19	50 m
871 18	Ø 18	18	21	25 m
871 26	Ø 26	26	29	25 m
871 29	Ø 29	29	32	25 m
871 37	Ø 37	37	41	25 m
871 40	Ø 40	40	48	25 m
871 50	Ø 50	50	55	25 m

- Hammadde: Kalaylı Çelik • Çalışma Sıcaklığı : -25° +150°
- Material : Tin-Coated Steel • Working Temperature: -25° +150°

**PVC KAPLI ÇELİK SİRALLER / PVC COATED STEEL TUBES**

Ürün Kodu Product Code	Nominal Çap Nominal Diameter	İç Çap (mm) Int. Diameter (mm)	Dış Çap (mm) Ex. Diameter (mm)	Ambalaj / adet Packaging / pcs
873 09	Ø 9	9	11,5	50 m
873 11	Ø 11	11	14	50 m
873 14	Ø 14	14	17	50 m
873 16	Ø 16	16	19	50 m
873 18	Ø 18	18	21	50 m
873 26	Ø 26	26	29	25 m
873 29	Ø 29	29	32	25 m
873 37	Ø 37	37	41	25 m
873 40	Ø 40	40	48	25 m
873 50	Ø 50	50	55	25 m

- Hammadde: Kaylı Çelik + Termo plastik PVC • Çalışma Sıcaklığı : -25° +80°
- Material : Tin-Coated Steel + Termo plastic PVC • Working Temperature: -25° +80°



GALVANİZLİ ÇELİK SİRALLER  
GALVENISED STEEL TUBE

GALVANİZLİ ÇELİK SİRALLER / GALVENISED STEEL TUBES



Ürün Kodu Product Code	Nominal Çap Nominal Diameter	İç Çap (mm) Int. Diameter (mm)	Dış Çap (mm) Ex. Diameter (mm)	Ambalaj / adet Packaging / pcs
872 09	Ø 9	9	11,5	50 m
872 11	Ø 11	11	14	50 m
872 14	Ø 14	14	17	50 m
872 16	Ø 16	16	19	50 m
872 18	Ø 18	18	21	50 m
872 26	Ø 26	26	29	25 m
873 29	Ø 29	29	32	25 m
872 37	Ø 37	37	41	25 m
872 40	Ø 40	40	48	25 m
872 50	Ø 50	50	55	25 m

- Hammedde: Kalaylı Çelik • Çalışma Sıcaklığı : -25° +150°
- Material : Tin-Coated Steel • Working Temperature: -25° +150°

PVC KAPLI GALVANİZLİ ÇELİK SİRALLER / PVC COATED GALVENISED STEEL TUBES



Ürün Kodu Product Code	Nominal Çap Nominal Diameter	İç Çap (mm) Int. Diameter (mm)	Dış Çap (mm) Ex. Diameter (mm)	Ambalaj / adet Packaging / pcs
874 09	Ø 9	9	11,5	50 m
874 11	Ø 11	11	14	50 m
874 14	Ø 14	14	17	50 m
874 16	Ø 16	16	19	50 m
874 18	Ø 18	18	21	50 m
874 26	Ø 26	26	29	25 m
874 29	Ø 29	29	32	25 m
874 37	Ø 37	37	41	25 m
874 40	Ø 40	40	48	25 m
874 50	Ø 50	50	55	25 m

- Hammedde: Kaylı Çelik + Termo plastik PVC • Çalışma Sıcaklığı : -25° +80°
- Material : Tin-Coated Steel + Termo plastic PVC • Working Temperature: -25° +80°

## ÇELİK SPİRALLER STEEL TUBES

### LIQUID TIGHT GALVANİZLİ ÇELİK SPİRAL LIQUID TIGHT GALVANIZED STEEL TUBES



Ürün Kodu Product Code	Nominal Çap Nominal Diameter	İç Çap (mm) Int. Diameter (mm)	Dış Çap (mm) Ex. Diameter (mm)	Ambalaj / adet Packaging / pcs
876 10	Ø 10	1/4" Ø10	14	30 m
876 13	Ø 13	3/8" Ø13	17	30 m
876 16	Ø 16	1/2" Ø16	21	30 m
876 21	Ø 21	3/4" Ø21	26	30 m
876 26	Ø 26	1" Ø26	32	30 m
876 35	Ø 35	1 1/4" Ø35	41	15 m
876 40	Ø 40	1 1/2" Ø40	47	15 m
876 52	Ø 52	2" Ø52	59	15 m
876 63	Ø 63	2 1/2" Ø63	72	15 m
876 78	Ø 78	3" Ø78	88	7.5 m
876 12	Ø 102	4" Ø102	112	7.5 m

### HALOJEN FREE PLASTİK KAPLI ÇELİK SPİRAL HALOGEN FREE PLASTIC COATED STEEL TUBES



Ürün Kodu Product Code	Nominal Çap Nominal Diameter	İç Çap (mm) Int. Diameter (mm)	Dış Çap (mm) Ex. Diameter (mm)	Ambalaj / adet Packaging / pcs
877 09	Ø 9	9	11,5	50 m
877 11	Ø 11	11	14	50 m
877 14	Ø 14	14	17	50 m
877 16	Ø 16	16	19	50 m
877 18	Ø 18	18	21	50 m
877 26	Ø 26	26	29	25 m
877 29	Ø 29	29	32	25 m
877 37	Ø 37	37	41	25 m
877 40	Ø 40	40	48	25 m
877 50	Ø 50	50	55	25 m
877 63	Ø 63	63	70	25 m

## DLX FİX ÇİVİLİ KROŞELER / DLX FIX NAIL CABLE CLIPS



Ref	No.	Açıklama / Descriptions	Paket Adet Bag Pcs.	Koli Adet Box Pcs.
771 00	0 (4 mm.)	0,75 Yassı Kablo 0,75 Cable	1.000	20.000
771 01	1 (4 mm.)	Kordon Kablo 0,75 Cable	1.000	20.000
771 02	2 (6 mm.)	Data Kablo Data Cable	1.000	20.000
771 03	3 (7 mm.)	2 x 1,5 - 3 x 1,5 TTR Kablo 2 x 1,5 - 3 x 1,5 TTR Cable	1.000	20.000
771 04	4 (8 mm.)	2 x 4 Antigrom Kablo 2 x 4 Antigrom Cable	1.000	20.000
771 05	5 (10 mm.)	2 x 4 - 4 x 4 Antigrom Kablo 2 x 4 - 4 x 4 Antigrom Cable	1.000	10.000
771 06	6 (12 mm.)	4 x 6 Antigrom Kablo 4 x 6 Antigrom Cable	1.000	10.000
771 07	7 (16 mm.)	4 x 10 Antigrom Kablo 4 x 10 Antigrom Cable	100	3.000
771 08	8 (25 mm.)	4 x 16 Antigrom Kablo 4 x 6 Antigrom Cable	100	2.000

## PLASTİK SIRA KLEMENSLER / PP PLASTIC TERMINAL STRIPS



REF	No.	Açıklama Descriptions	Bağlantı Poles	A	W	Adet / Pcs. Packing
772 01	No 1	2,5-4 mm <sup>2</sup>	12	32	400	50
772 02	No 2	4-6 mm <sup>2</sup>	12	41	400	50
772 03	No 3	6-10 mm <sup>2</sup>	10	57	400	50
772 04	No 4	10-16 mm <sup>2</sup>	6	76	500	50
772 05	No 5	16-25 mm <sup>2</sup>	6	101	500	50

Renk : Mavi, Siyah / MS 58 Piriç / Color : Blue, Black / MS 58 Bras  
Çalışma Ortamı Sıcaklığı / Continuous Working Temperature 110 °C

## ISIYA DAYANIKLI PLASTİK SIRA KLEMENSLER PA PLASTIC TERMINAL STRIPS



REF	No.	Açıklama Descriptions	Bağlantı Poles	A	W	Adet / Pcs. Packing
773 01	No 1	2,5-4 mm <sup>2</sup>	12	32	400	50
773 02	No 2	4-6 mm <sup>2</sup>	12	41	400	50
773 03	No 3	6-10 mm <sup>2</sup>	10	57	400	50
773 04	No 4	10-16 mm <sup>2</sup>	6	76	500	50
773 05	No 5	16-25 mm <sup>2</sup>	6	101	500	50

Renk : Beyaz / MS 58 Piriç / Color : White / MS 58 Bras  
Çalışma Ortamı Sıcaklığı / Continuous Working Temperature 140 °C

## 12'Lİ GEÇMELİ SOKET KLEMENS / 12 SOCKET CONNETORS WITH POLE (ONE-PIECE) TERMINAL STRIPS

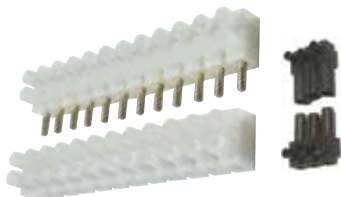

REF	Açıklama Descriptions	Adet / Pcs. Packing
772 06	12'li / 12 Pole 4 mm <sup>2</sup>	25
772 07	3'lü / 3 Pole 2,5-6 mm <sup>2</sup>	100

Erkek-Dişi Kilitlemeli / Male - Female Lock System

## PORSELEN KLEMENSLER / STEATITE TERMINALS

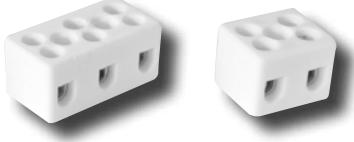

REF	No.	Açıklama / Descriptions	Adet / Pcs. Packing
774 01	No 1	2'li Lüster / 2 Pole 2,5 - 4 mm	150
774 02	No 1	3'lü Lüster / 3 Pole 2,5 - 4 mm	100
774 03	No 2	2'li Lüster / 2 Pole 2,5 - 4 - 6mm	100
774 04	No 2	3'lü Lüster / 3 Pole 2,5 - 4 - 6 mm	50
774 05	No 3	2'li Lüster / 2 Pole 6 - 10 mm	50
774 06	No 3	3'lü Lüster / 3 Pole 6 - 10 mm	50
774 07	No1	1'li Lüster / 1 Pole 2,5 - 4 mm	200
774 08	No 2	1'li Lüster / 1 Pole 2,5 - 6 mm	100
774 09	No 3	1'li Lüster / 1 Pole 4 - 6 mm	50

## DAĞITICI ÜNİTELER / DISTRIBUTION UNITS

### 1 KUTUPLU DAĞITICI ÜNİTE

### 1 SINGLE POLE DISTRIBUTION UNITS (7x12 mm) 125 A



REF	Açıklama / Descriptions	L	C	F	Adet / Pcs. Packing
300 01	2/5 7 Delikli 7 Holes	76	44	42	25
300 02	2/8 10 Delikli 10 Holes	100	44	42	25
300 03	2/10 12 Delikli 12 Holes	115	44	42	25
300 04	2/13 15 Delikli 15 Holes	135	44	42	25
300 05	2/20 22 Delikli 22 Holes	185	44	42	25

### 2 KUTUPLU DAĞITICI ÜNİTE (7x12 mm) 125 A

### 2 POLE DISTRIBUTION UNITS (7x12 mm) 125 A

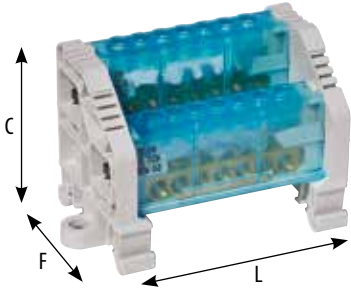

REF	Açıklama / Descriptions	L	C	F	Adet / Pcs. Packing
300 06	2/5 7 Delikli 7 Holes	65	45	47	22
300 07	2/8 10 Delikli 10 Holes	88	45	47	15
300 08	2/10 12 Delikli 12 Holes	102	45	47	14
300 09	2/13 15 Delikli 15 Holes	126	45	47	12
300 10	2/20 22 Delikli 22 Holes	162	45	47	6

### 4 KUTUPLU DAĞITICI ÜNİTE (7x12 mm) 125 A

### 4 POLE DISTRIBUTION UNITS (7x12 mm) 125 A

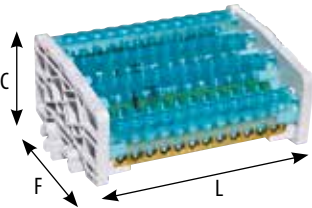

REF	Açıklama / Descriptions	L	C	F	Adet / Pcs. Packing
300 11	2/5 7 delikli 7 Holes	65	45	47	22
300 12	2/8 10 delikli 10 Holes	88	45	47	15
300 13	2/10 12 delikli 12 Holes	102	45	47	14
300 14	2/13 15 delikli 15 Holes	126	45	47	12
300 15	2/20 22 delikli 22 Holes	175	45	47	6

**CAM ELYAF TAKVİYELİ ELEKTRİK DAĞITIM PANOSU**  
**GLASS REINFORCED POLYESTER ELECTRICAL DISTRIBUTION BOARD**Ref:310 08  
600x800x220Ref:310 07  
500x700x200Ref:310 06  
400x600x200Ref:310 05  
350x500x170Ref:310 04  
300x400x170Ref:310 02  
250x300x170Ref:310 01  
200x300x120**KİLİT SEÇENEKLERİ**

## LOCK OPTIONS

Pako Kilit  
Paco LockAsma Kilit Hamili  
Çeyrek Dönüştü Kilit  
Padlockable  
Wing KnobSİLİNDİRİ  
KELEBEK KİLİT  
Cam Lock-Wing  
KnobYaylı Pano KİLİDİ  
KELEBEK (Metal Klipsli)  
Quarter Turn  
With Wing Knob  
(Metal Clip)Yaylı Pano KİLİDİ (Plastik Üçgen)  
Quarter Turn With Spring  
(Plastic Triangular)**Standart Kilit Sistemi**  
**Standard Locking System**

## CAM ELYAF TAKVİYELİ ELEKTRİK DAĞITIM PANOSU GLASS REINFORCED POLYESTER ELECTRICAL DISTRIBUTION BOARD



### GENEL ÖZELLİKLER COMMON SPECIFICATION

- ✓ Paslanmaz, çizilmez, boya bakım gerektirmez.
- ✓ Elektrik iletmez, yalıtıcıdır.
- ✓ Alev iletmez ve kendiliğinden söner.
- ✓ Rutubet, nem barındırmaz.
- ✓ Atmosferik şartlara karşı dayanıklıdır.
- ✓ Üzerine logo istenildiği gibi yapılabilir.
- ✓ Rustproof, unscratchable paint, no need painting & maintenance.
- ✓ Dielectric.
- ✓ Flameproof, self-extinguishing.
- ✓ Non-affected by humidity.
- ✓ Resistant to atmosphere conditions.
- ✓ Your logo can be placed on.

### TEKNİK ÖZELLİKLER TECHNICAL SPECIFICATION

Hammadde	: Cam Elyaf Takviyeli Polyester	Raw Material	: Glass Reinforced Polyester
Kalite Standardı	: EN61439, EN60670-1	Quality Standart	: EN61439, EN60670-1
Renk	: RAL 7035 (Renk Seçenekleri vardır)	Color	: RAL 7035 (There are color options)
Çalışma Sıcaklığı	: -40°+70°C	Operating Temperature:	-40°+70°C
Kapak Açılma Açısı:	210	Door Opening Angle	: 210
Menteşe	: 2/3 Adet	Hinge	: 2/3 Pieces
Kilit	: 1/2 Adet	Lock	: 1/2 Pieces
Kilit Seçenekleri	: Üçgen, Kelebek, Yaylı, Sıkıştırılmalı (metal veya plastik)	Lock Options	: Triangle, Butterfly, Springy, Compression (Metal or Plastic)
Koruma Kılıfı	: IP 54 / IP65	Protection Class	: IP 54 / IP65
Yangın Dayanımı	: B2 (İstenildiğinde A1, A2, B1, V0)	Fire Resistance	: B2 (Can change to A1, A2, B1, V0)
UV Dayanımı	: Talebe göre eklenebilir	UV Resistance	: Can be added acc.to request
Nem Dayanımı	: Evet	Humidity Resistance	: Yes
Kimyasal Dayanımı:	Asit ve Bazlara Karşı Tam Koruma	Chemical Resistance	: Full Protection Against acid and base
Aşınma Dayanımı	: Olumsuz hava koşullarına karşı yüksek dayanım	Corrosion Resistance	: High Resistance Against adverse weather conditions
Conta	: Poliüretan dökme conta veya EPDM conta	Gasket	: Polyurathane foam gasket or EPDM gasket
Topraklama Sınıfı	: Class II	Grounding Class	: Class II

# SERTİFİKALAR / CERTIFICATES



DLX'in yenilikçi ürün sistemleri endüstri tasarım tescil ve faydalı model belgeleri ile koruma altında olup sınai mülkiyet hakkımız saklıdır. İzin alınmadan kopya edilemez.

© Copyright

DLX innovative product systems and industrial design registration are protected under the utility model documents and reserve the right of industrial property. May not be copied without permission.

© Copyright

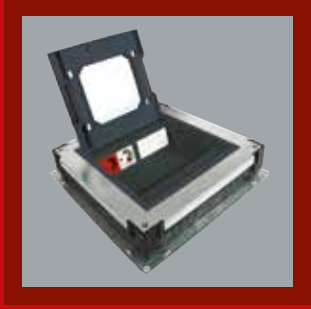
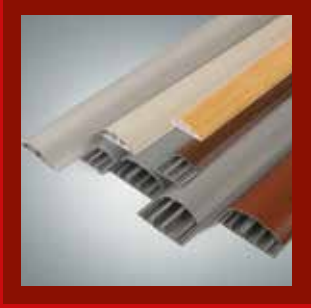

Yetkili Satıcı  
Distributed by



**DLX**<sup>®</sup> **DLT ELEKTRİK PLASTİK  
KALIP SAN. ve TİC. LTD. ŞTİ.**  
*electric*

Osmangazi Mah. 3130. Sk. No : 6 Kat : 1  
34522 Kırış-Esenyurt/İSTANBUL-TÜRKİYE  
Tel : +90 212 886 40 51 - 52  
Fax : +90 212 886 40 53

e-mail : info@dlx.com.tr

web : www.dlx.com.tr

+90 530 416 85 25